

TRULINE .5A TUNABLE WHITE

24VDC, 5/8" DRYWALL PLASTER-IN LED SYSTEM

DESIGNED BY GREGORY KAY | ASSEMBLED IN AMERICA

REV 12.21.22

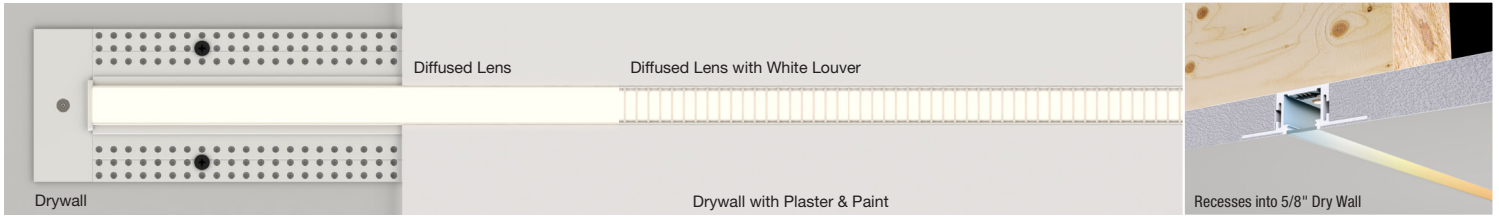

DESCRIPTION

PureEdge pioneered the TruLine .5A Plaster-in 24VDC LED system that Recesses within 5/8" drywall, without any joist modification. Redefining the relationship between Lighting and Interior Design, this Innovative and highly Efficient system blends seamlessly into the drywall, becoming part of the Architecture. The slim extrusions, LED strips, and lenses are field-cuttable and ordered in 1' increments (up to 40' before re-feeding). Multiple runs of channel mount flawlessly together providing smooth and Glare-free general illumination using Designer-grade Color Rendering LEDs (95+ CRI). With the ability to run in vertical, horizontal, and diagonal directions, the compositions are truly endless. Tunable White 2000K-6500K (**2K6K**) or 2700K-6500K (**27K6**) grants independent control and adjustment of color temperature and intensity from 2000K (Sunset) through 6500K (Day Light White). Tunable white lighting visually, biologically and emotionally contributes to human interaction with the physical world. Human centric lighting (HCL) builds on this technology bringing the dynamics of natural daylight indoors, and delivering a positive effect on human health, wellbeing and performance. Click here for all [Other Color Temperatures](#). Coordinate installation with electrical and drywall contractors. Includes a 5-year pro-rated warranty. For custom designs and quotes, send drawings to design@PureEdgeLighting.com.

DESIGN NOTE

TruLine .5A can be installed on a single surface, join runs on multiple planes from wall to ceiling, or from one wall to an adjacent wall. Use TruLine .5A Build-It-Yourself (**BIY**) with pre-formed components to create desired configurations, including Mitered Picture Frame and Outside or Inside Corners for Room Wrapping installations. Create square or rectangular compositions with TruQuad .5A.

ORDERING & INSTALLATION

TruLine .5A can be secured to studs spaced 13"-24" apart or between studs with provided mounting straps. Requires Remote Power Supply (ordered separately) In-Wall Mounting Kits are available for select power supplies. Order in 1' increments, field-cuttable to any length.

MAXIMUM LENGTHS BEFORE RE-FEEDING

- 2WDC, 2.5 watts per foot - 40'
- 5WDC, 5 watts per foot - 20'

LAMP

- Tunable White: 2000K-6500K (**2K6K**) and 2700K-6500K (**27K6**) grants independent control for adjusting color temperature and intensity
- Lumen Performance: 269lm/ft at 3000K 5W per foot
- Average life: 50,000 hours
- For additional color temperatures refer to their respective specification

REMOTE POWER SUPPLIES*, DIMMERS & CONTROLS (SOLD SEPARATELY)

24VDC, Class 2 wiring

- [Pure Smart™ Wiz Pro Power Supplies & Controls](#)
- [0-10V](#) Requires two dimmers, one for intensity and one for color temperature
- [DMX Dynamic Color Changing](#)
- [Controllers](#)

*In-Wall Mounting and drop ceiling Kits available for select power supplies

APPLICATIONS

Designed for any Indoor space with drywall, including Damp locations. Ideal applications in Residential, Commercial, Retail, and Hospitality environments.

COMPLIANCE

ETL, RoHS, Class 2, Damp Location, Made in USA, *Title 24 JA8 listed for 2700K CCT and above when used with PureEdge remote Universal power supplies,

For quick & easy reference, plus the most up-to-date pricing, use our [TruLine .5A Configurator](#)

PureEdge is the Original Designer of 5/8" Drywall Lighting Products with the Most Experience in the industry.

System	Watts Per Foot	Length in Feet	Color Temperature
TL.5A	5WDC	20FT	ST2K6K
TL.5A TruLine .5A	2WDC 2.5 Watts (40ft Max)	1-40FT	ST2K6K Tunable White 2000K-6500K
TL.5ADW TruLine .5A with White Louver	5WDC 5 Watts (20ft Max)	1-20FT	ST27K6 Tunable White 2700K-6500K

PROJECT	FIXTURE TYPE	DATE
---------	--------------	------

TRULINE .5A TUNABLE WHITE

24VDC, 5/8" DRYWALL PLASTER-IN LED SYSTEM

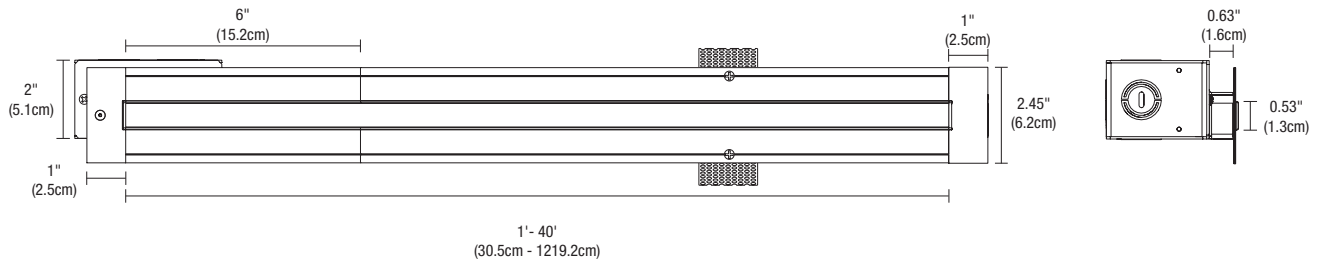

INCLUDED COMPONENTS

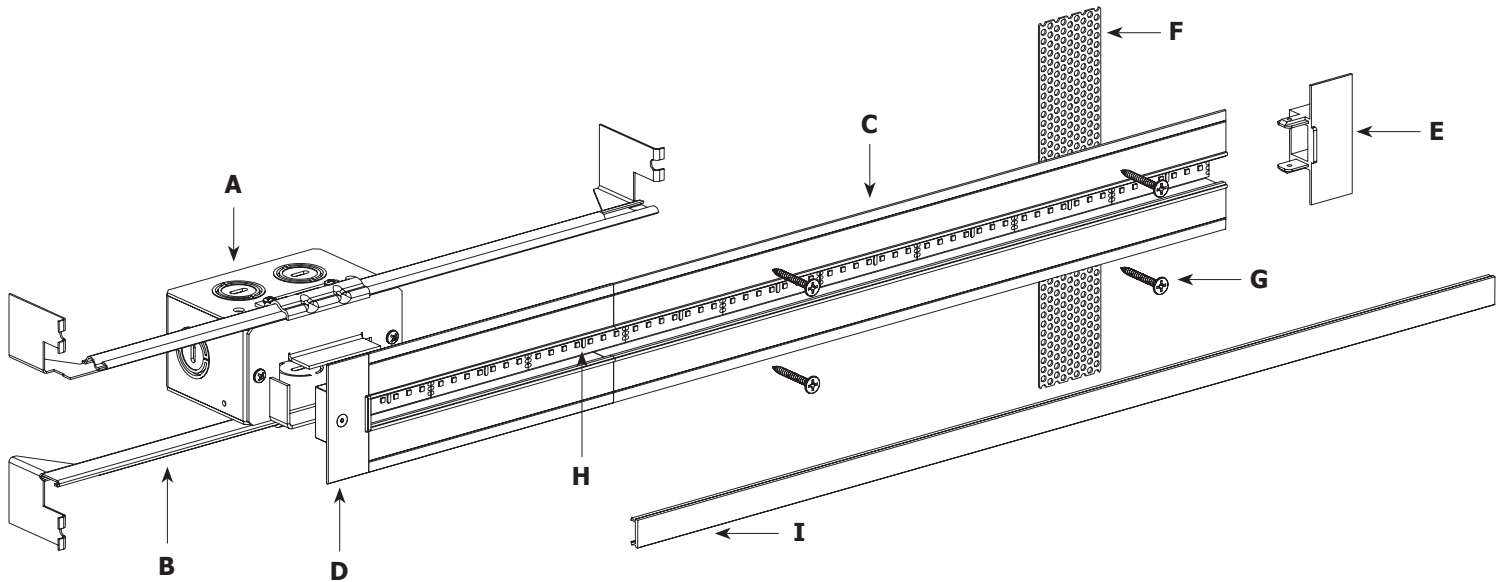

A. JUNCTION BOX

Mounts behind drywall with Adjustable Mounting Bars. Low Voltage 24VDC wires from Remote Power Supply connect to LED wires inside box. Junction Box opening is covered by channel. Required at the beginning of each run and necessary to rough-in electrical before TruLine installation. Junction Box is also included with each TruLine channel order

B. ADJUSTABLE MOUNTING BARS

Provide flexibility for mounting in a variety of spaces and orientations. May be secured to studs that are spaced 13"-24" apart.

C. TRULINE .5A CHANNEL

5/8" deep extrusion houses single row of LED Strip.

D. POWER END CAP

Provides a finished look and prevents light leak at the feed-end of a run where LED Strip enters channel.

E. TAKE-UP BOX

Prevents dark spots at the end of a run by tucking excess LED Strip safely behind the wall.

F. MOUNTING STRAP

Secures channel to drywall when wall stud is unavailable.

G. DRYWALL SCREW

Secures channel to drywall and stud.

H. LED STRIP

Your selection of LED Strip.

I. LENS

0.5" wide diffused white lens projects a clean line of light without LED pixelation.

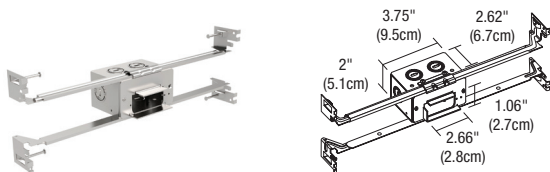

JUNCTION BOX ROUGH-IN COMPONENT

One Junction Box is included with TruLine .5A. Order additional Junction Box separately to rough-in electrical wiring before drywall installation. Quick shipment available.

System	Size	Component
TL.5A	1RE	JBOX
TL.5A TruLine .5A	1RE 1" Rectangle	JBOX Junction Box

PROJECT	FIXTURE TYPE	DATE
---------	--------------	------

TRULINE .5A TUNABLE WHITE

24VDC, 5/8" DRYWALL PLASTER-IN LED SYSTEM

REV 12.21.22

NOMINAL DELIVERED LUMENS

WATTS PER FOOT	TUNABLE WHITE 2K6K (2000K-6500K)										TUNABLE WHITE 2K6K (2000K-6500K)									
	2.5W										4.4W									
COLOR TEMPERATURE	20K	22K	24K	27K	30K	35K	40K	57K	65K	20K	22K	24K	27K	30K	35K	40K	57K	65K		
LUMENS PER FOOT (lm/ft)	96	97	98	100	101	104	113	122	131	231	241	250	260	269	288	308	311	314		
LUMENS PER WATT (lm/w)	52	50	49	50	51	52	57	61	73	58	56	54	56	58	63	67	68	79		
CRI	92+	92+	92+	92+	92+	95+	93+	93+	93+	92+	92+	92+	92+	92+	95+	93+	93+	93+		

WATTS PER FOOT	TUNABLE WHITE 27K6 (2700K-6500K)								TUNABLE WHITE 27K6 (2700K-6500K)							
	2.5W								4.4W							
COLOR TEMPERATURE	27K	30K	35K	40K	45K	57K	65K	27K	30K	35K	40K	45K	57K	65K		
LUMENS PER FOOT (lm/ft)	164	195	201	206	225	242	231	258	264	274	284	280	278	277		
LUMENS PER WATT (lm/w)	82	78	80	82	90	97	115	64	57	59	62	61	60	69		
CRI	92+	92+	92+	95+	93+	93+	93+	92+	92+	92+	95+	93+	93+	93+		

To determine the necessary wire gauge use our [Voltage Drop Calculator](#)

LENGTH LOAD CHARTS

2.5 WATTS PER FOOT

LENGTH IN FEET	WATTS	LENGTH IN FEET	WATTS	LENGTH IN FEET	WATTS	LENGTH IN FEET	WATTS
1	3	11	27	21	51	31	75
2	5	12	29	22	54	32	78
3	8	13	32	23	56	33	80
4	10	14	34	24	58	34	82
5	13	15	37	25	61	35	85
6	15	16	39	26	63	36	87
7	17	17	41	27	66	37	90
8	20	18	44	28	68	38	92
9	22	19	46	29	70	39	94
10	24	20	48	30	72	40	96

5 WATTS PER FOOT

LENGTH IN FEET	WATTS	LENGTH IN FEET	WATTS	LENGTH IN FEET	WATTS	LENGTH IN FEET	WATTS
1	5	6	30	11	54	16	78
2	10	7	34	12	58	17	82
3	16	8	40	13	64	18	88
4	20	9	44	14	68	19	92
5	24	10	48	15	72	20	96

PROJECT		FIXTURE TYPE		DATE	
---------	--	--------------	--	------	--

LED STRIP TM30 DATA

24VDC, 5/8" DRYWALL PLASTER-IN LED SYSTEM

TM-30-15 DATA: The data below is for Tunable White bare LED Strip. Consistent color temperatures throughout a single strip and among multiple strips is possible through a 3 phase binning process in which each order is inspected with a color meter to ensure uniformity.

2000K ONLY (2K6K/27K6) | Rf: 90.6 | Rg: 98.5

Color Vector Graphic

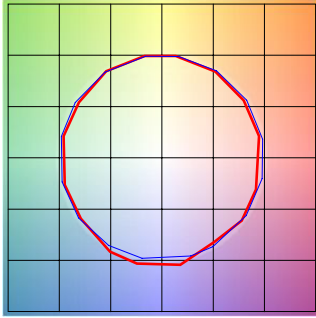

■ Test ■ Reference

		GRAPHIC SHIFTS %	
HUE BIN	Rf	CHROMA	HUE
1	87.7	-5.5%	1.2%
2	88.7	-3.9%	4.2%
3	90.5	-1.5%	4.3%
4	95.0	-1.7%	0.8%
5	95.2	-0.2%	2.1%
6	94.2	1.6%	1.9%
7	95.9	-0.8%	-2.2%
8	95.5	-1.7%	1.3%
9	93.8	-1.4	2.6%
10	91.9	-0.7%	4.2%
11	91.3	3.6%	3.7%
12	91.2	4.2%	-1.0%
13	86.6	3.8%	-12.7%
14	67.2	-3.0%	-16.3%
15	84.9	-3.3%	-9.4%
16	84.2	-5.7%	-7.5%

3000K (2K6K/27K6) | Rf: 90.5 | Rg: 100.7

Color Vector Graphic

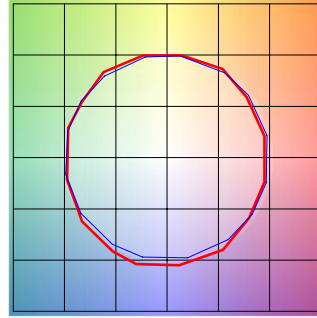

■ Test ■ Reference

		GRAPHIC SHIFTS %	
HUE BIN	Rf	CHROMA	HUE
1	91.5	-3.5%	1.2%
2	92.4	-1.8%	2.7%
3	89.8	0.3%	4.5%
4	92.4	-1.7%	0.4%
5	93.3	-0.1%	1.4%
6	94.5	2.1%	-0.6%
7	91.0	-2.5%	0.3%
8	96.9	-0.8%	-0.2%
9	91.6	-0.9%	4.6%
10	86.7	0.7%	7.8%
11	86.3	3.8%	8.5%
12	88.3	6.1%	0.6%
13	90.9	3.1%	-5.2%
14	87.3	4.7%	-7.9%
15	92.1	-1.9%	-2.5%
16	84.5	-0.9%	-10.9%

4000K ONLY (2K6K/27K6) | Rf: 86.4 | Rg: 96.1

Color Vector Graphic

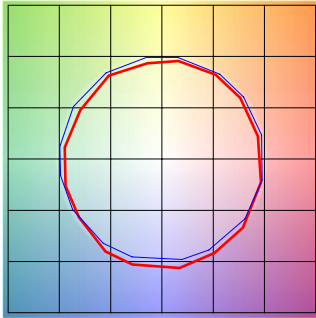

■ Test ■ Reference

		GRAPHIC SHIFTS %	
HUE BIN	Rf	CHROMA	HUE
1	86.5	-5.5%	1.3%
2	90.4	-3.0%	2.3%
3	89.8	-2.1%	3.6%
4	89.1	-3.4%	0.4%
5	88.5	-5.9%	0.1%
6	93.6	-3.0%	-0.4%
7	88.9	-6.2%	1.7%
8	87.3	-5.0%	4.9%
9	82.4	-3.6%	11.3%
10	77.4	-1.8%	12.7%
11	79.8	4.9%	11.4%
12	88.7	4.4%	2.7%
13	88.7	4.0%	-5.1%
14	91.2	2.2%	-3.8%
15	82.7	-0.1%	-9.2%
16	82.8	-2.2%	-7.6%

PROJECT	FIXTURE TYPE	DATE
---------	--------------	------