

# REVEAL WALL WASH

24VDC - PLASTER-IN LED SYSTEM, STATIC WHITE OR WARM DIM

DESIGNED BY GREGORY KAY | MADE IN AMERICA

REV 07.08.20



## DESCRIPTION

Reveal Wall Wash, a 24VDC linear LED system, features a shallow, plaster-in aluminum extrusion, that is no thicker than drywall. The system may be secured directly to studs without joist modification and plasters into 5/8" thick drywall or between studs with mounting clips provided. Must be mounted 24" away from the projected wall. Sold in 1' increments up to 20' (**5WDC**), 16' (**6WDC**), 12' (**7WDC**), or 10' (**10WDC**) and field cuttable to any length. Several color temperature options are available, from 22K though 57K, and Warm Dim options (**27D** or **30D**). High CRI commercial-grade Static White or Warm Dim LED Soft Strip projects a clean line of light. Coordinate installation with electrician and drywall contractors. Includes a 5 year pro-rated warranty.

## DESIGN NOTE

Reveal Wall Wash is an ideal wall washing solution for contemporary spaces. Multiple runs of channel mount seamlessly together and may wrap inside corners to wash surrounding walls with uniform controlled illumination up to 95+ CRI.

## FINISHES



Satin Aluminum  
**SA**

White  
**WH**

## LAMP

The average LED Life is 50,000 hours.

## REMOTE POWER SUPPLIES\*, DIMMERS & CONTROLS (SOLD SEPARATELY)

- Universal Power Supplies (**UNI**)
- Lutron Hi-Lume®
- Electronic Low Voltage Dimming (**ELV**)†
- 0-10 Volt Dimming (**0-10V**)

\*In-Wall Mounting Kits available for select power supplies

† With N-Lite Dimming Do Not use ELV power supply's, use only 0-10 volt or Uni drivers power supplies

## APPLICATIONS

Indoor damp or dry locations only. Wall Wash, General, and Retail

## INCLUDED COMPONENTS

Junction Box, Adjustable Mounting Bars, Reveal Wall Wash Channel(s), Power Feed End Cap, Junction Box Cover, Dead End Cap, Take-Up Box, Drywall Screws, LED Soft Strip, and Lens(es)

System	Watts Per Foot	Length in Feet	Color Temperature	Reflector Finish
<b>RVWW</b>	<b>5WDC</b>	<b>20FT</b>	<b>27K</b>	<b>SA</b>
<b>RVWW</b> Reveal Wall Wash	<b>5WDC</b> 4.4 Watts <b>7WDC</b> 7.5 Watts <b>10WDC</b> 9.6 Watts	<b>1-20FT</b> 5WDC <b>1-12FT</b> 7WDC <b>1-10FT</b> 10WDC	<b>22K</b> 2200K Candle White <b>24K</b> 2400K Very Warm White <b>27K</b> 2700K Incandescent White <b>27D</b> 2700K Warm Dim (5WDC only) <b>30K</b> 3000K Warm White <b>30D</b> 3000K Warm Dim (5WDC only) <b>35K</b> 3500K Neutral White <b>40K</b> 4000K Cool White <b>57K</b> 5700K Daylight White	<b>SA</b> Satin Aluminum <b>WH</b> White

PROJECT	FIXTURE TYPE	DATE
---------	--------------	------

# REVEAL WALL WASH

24VDC - PLASTER-IN LED SYSTEM, STATIC WHITE OR WARM DIM

DESCRIPTION	RVWW																						
	REVEAL WALL WASH																						
	5W (4.4 watts)										7W (7.5 watts)					10W (9.6 watts)							
WATTS PER FOOT	22K	24K	27K	27D*	30K	30D*	35K	40K	57K	22K	24K	27K	30K	35K	40K	57K	22K	24K	27K	30K	35K	40K	57K
COLOR TEMPERATURE	22K	24K	27K	27D*	30K	30D*	35K	40K	57K	22K	24K	27K	30K	35K	40K	57K	22K	24K	27K	30K	35K	40K	57K
LUMENS PER FOOT (lm/ft)	172	191	209	228	229	250	262	285	303	285	316	347	380	435	473	503	374	416	457	499	572	622	661
LUMENS PER WATT (lm/w)	39	43	48	48	52	52	60	65	69	39	43	48	52	60	65	69	39	43	48	52	60	65	69
CRI	85+	90+	95+	95+	95+	95+	85+	84	84	85+	90+	95+	95+	85+	84	84	85+	90+	95+	95+	85+	84	84

\*27D, 30D - Warm Dim (4.8 Watts)

## INCLUDED COMPONENTS

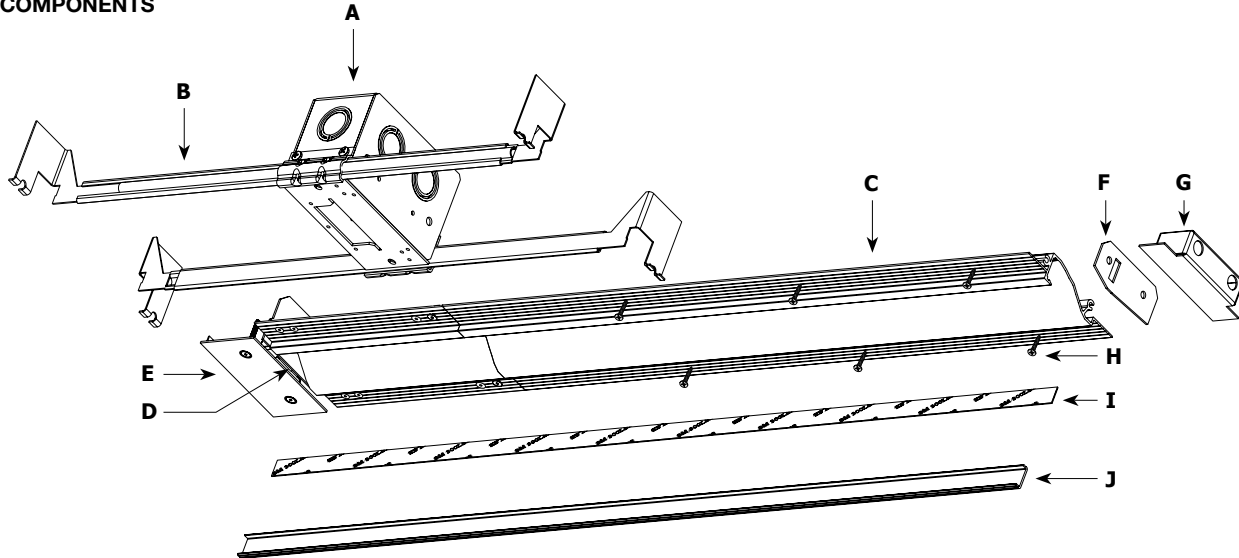

### A. JUNCTION BOX

Mounts behind drywall with Adjustable Mounting Bars and includes a drywall template for accurate installation. Low Voltage 24VDC wires from Remote Power Supply connect to LED wires inside box. Junction Box opening is concealed with the Reveal Wall Wash Junction Box cover and is required at the beginning of each run.

### B. ADJUSTABLE MOUNTING BARS

Provide flexibility for mounting in a variety of spaces.

### C. REVEAL WALL WASH CHANNEL

5/8" deep extrusion houses a single row of commercial-grade White or Dynamic Color Changing LED Soft Strip.

### D. POWER FEED END CAP

Provides a connection area for 24VDC wires at beginning of run where LED Soft Strip enters channel.

### E. JUNCTION BOX COVER

Conceals Junction Box opening. Required at the beginning of each run.

### F. DEAD END CAP PLATE

Provides a finished look and prevents light leak at feed-end of run where LED Soft Strip exits channel.

### G. TAKE-UP BOX

Prevents dark spots at end of run by tucking excess LED Soft Strip safely behind wall.

### H. DRYWALL SCREWS

Secure channel to drywall and stud.

### I. LED SOFT STRIP

(Back Side shown) commercial-grade White or Dynamic Color Changing LED Soft Strip. See lamp data on for additional details.

### J. LENS

0.74" wide diffuser lens projects a clean line of light without LED dots.

## JUNCTION BOX ROUGH-IN COMPONENT

One Junction Box is included with Reveal Wall Wash. Order additional Junction Box separately to rough-in electrical wiring before drywall installation. Quick shipment available.

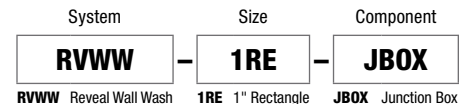
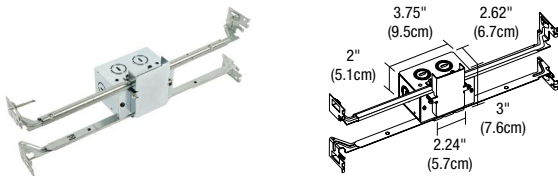

PROJECT	FIXTURE TYPE	DATE
---------	--------------	------

# REVEAL WALL WASH

24VDC - PLASTER-IN LED SYSTEM, STATIC WHITE OR WARM DIM

## INSTALLATION

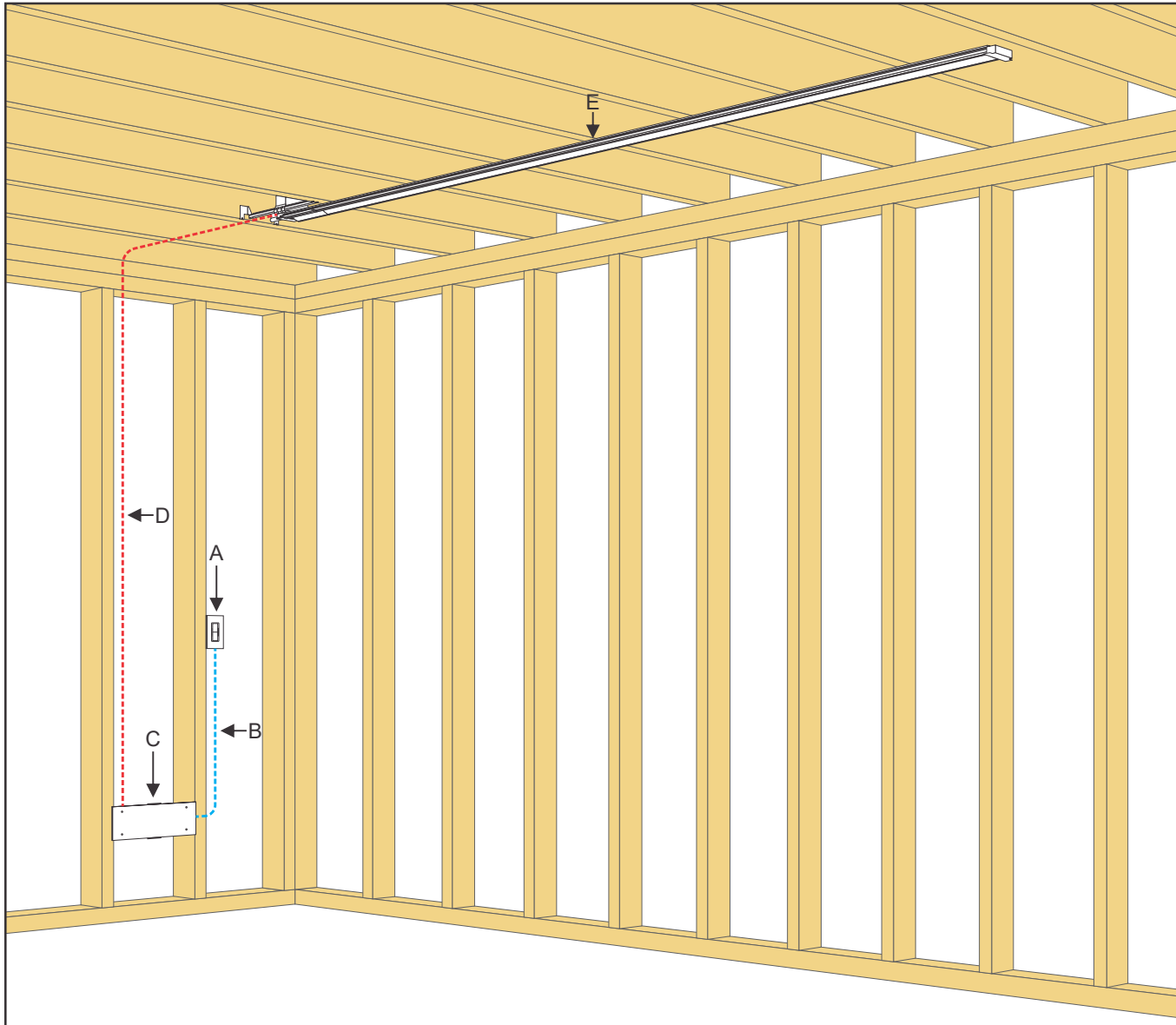

- A. DIMMER OR SWITCH.
- B. 120VAC WIRING TO 120V/24VDC REMOTE POWER SUPPLY, FOR IN-WALL MOUNTING KIT.
- C. IN-WALL MOUNTING KIT.
- D. 24VDC, CLASS 2 WIRING.
- E. REVEAL WALL WASH STANDARD FIXTURE.

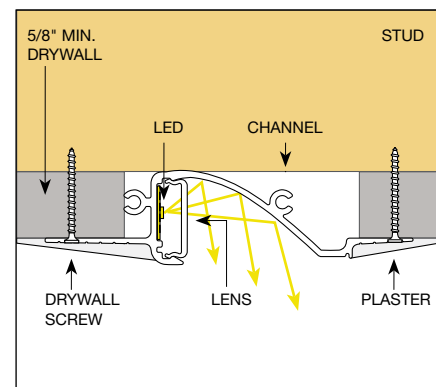

■ Direction of Light

PROJECT	FIXTURE TYPE	DATE
---------	--------------	------

# REVEAL WALL WASH

24VDC - PLASTER-IN LED SYSTEM, STATIC WHITE OR WARM DIM

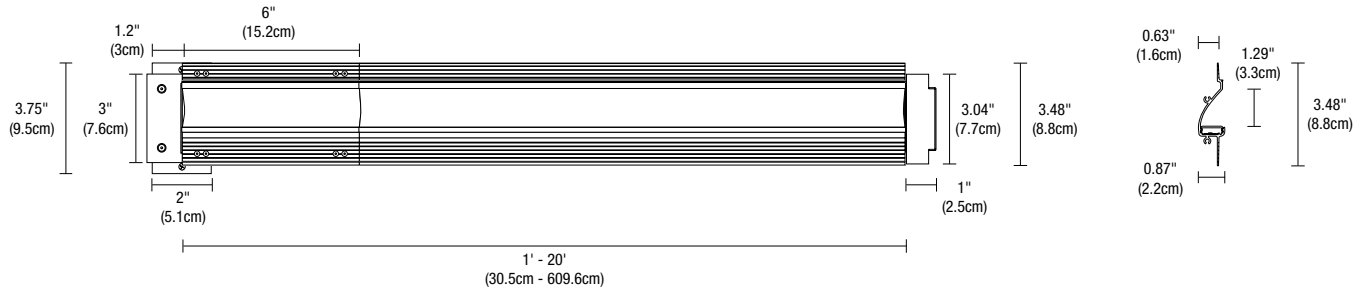

**WALL WASH FOOT CANDLE DISTRIBUTION  
SHOWN WITH 10 WATT, 3000K VERSION**

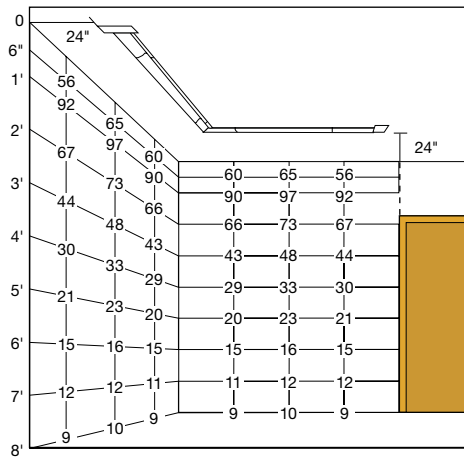

**WALL WASH DIRECTION OF LIGHT  
SHOWN WITH 10 WATT, 3000K VERSION**



**5 WATTS PER FOOT - 22K, 24K, 27K, 27D, 30K, 30D, 35K, 40K, 57K, 2K4K & RGB LEDS**

LENGTH IN FEET	WATTS
1	5
2	10
3	16
4	20
5	24

LENGTH IN FEET	WATTS
6	29
7	34
8	38
9	43
10	48

LENGTH IN FEET	WATTS
11	53
12	58
13	63
14	67
15	72

LENGTH IN FEET	WATTS
16	77
17	82
18	87
19	91
20	96

**7.5 WATTS PER FOOT - 22K, 24K, 27K, 30K, 35K, 40K & 57K WHITE LEDS**

LENGTH IN FEET	WATTS
1	8
2	15
3	23

LENGTH IN FEET	WATTS
4	30
5	38
6	45

LENGTH IN FEET	WATTS
7	53
8	60
9	68

LENGTH IN FEET	WATTS
10	75
11	83
12	90

**10 WATTS PER FOOT - 22K, 224K, 7K, 30K, 35K, 40K, 57K LEDS**

LENGTH IN FEET	WATTS
1	10
2	20
3	30

LENGTH IN FEET	WATTS
4	40
5	50
6	60

LENGTH IN FEET	WATTS
7	70
8	80
9	90

LENGTH IN FEET	WATTS
10	100

PROJECT		FIXTURE TYPE		DATE	
---------	--	--------------	--	------	--

# INDOOR CONSTANT VOLTAGE REMOTE POWER SUPPLIES

24VDC, UNI - UNIVERSAL DIMMING WITH ELV, TRIAC, & 0-10V

REV 07.08.20

UNIVERSAL POWER SUPPLIES & RECOMMENDED DIMMERS				
ORDERING CODE	PSB-40W-UNI-24VDC	PSB-60W-UNI-24VDC	PSB-2X40W-UNI-24VDC	PSB-2X60W-UNI-24VDC
<b>SPECIFICATIONS</b>				
<b>MAXIMUM LOAD</b>	40W	60W	2X40W	2X60W
<b>INPUT VOLTAGE</b>	120-277VAC	120-277VAC	120-277VAC	120-277VAC
<b>OUTPUT VOLTAGE</b>	24VDC	24VDC	24VDC	24VDC
<b>DIMENSIONS</b>	12.4" X 3.12" X 2.18"	12.4" X 3.12" X 2.18"	12.15" X 6.48" X 2.18"	12.15" X 6.48" X 2.18"
<b>CLASSIFICATION</b>	CLASS 2	CLASS 2	CLASS 2	CLASS 2
<b>IN-WALL MOUNTING</b>	PSB-40W-UNI-24VDC-IW	PSB-60W-UNI-24VDC-IW	PSB-2X40W-UNI-24VDC-IW	PSB-2X60W-UNI-24VDC-IW
UNIVERSAL POWER SUPPLIES & RECOMMENDED DIMMERS				
ORDERING CODE	PSB-96W-UNI-24VDC	PSB-2X96W-UNI-24VDC	PSB-3X96W-UNI-24VDC	PSB-4X96W-UNI-24VDC
<b>SPECIFICATIONS</b>				
<b>MAXIMUM LOAD</b>	96W	2X96W	3X96W	4X96W
<b>INPUT VOLTAGE</b>	120-277VAC	120-277VAC	120-277VAC	120-277VAC
<b>OUTPUT VOLTAGE</b>	24VDC	24VDC	24VDC	24VDC
<b>DIMENSIONS</b>	12.4" X 3.12" X 2.18"	12.15" X 6.48" X 2.18"	14" X 10" X 3"	17" X 13" X 3"
<b>CLASSIFICATION</b>	CLASS 2	CLASS 2	CLASS 2	CLASS 2
<b>IN-WALL MOUNTING</b>	PSB-96W-UNI-24VDC-IW	PSB-2X96W-UNI-24VDC-IW	NA	NA
<b>ELV DIMMING &amp; CONTROLS</b>				
LUTRON DIVA: DVELV-300P	•	•	•	•
LUTRON SKYLARK: SELV-300P	•	•	•	•
LUTRON RADIO RA2: RRD-6NA	•	•	•	•
LUTRON MAESTRO: MAELV-600	•	•	•	•
LEGRAND ADORNE: ADTP-703TUM4	•	•	•	•
<b>0-10 DIMMING &amp; CONTROLS</b>				
PHILIPS SUNRISE: SR1200ZTUNV	•	•	•	•
LUTRON DIVA: DDTV-WH, DVSTV-WH	•	•	•	•
LUTRON NOVA T: NTSTV-DV-XX	•	•	•	•
LUTRON GRAFIX EYE QS: QSGRJ-XP	•	•	•	•
LUTRON RADIO RA2: RRD-10ND	•	•	•	•
LEVITON: LEV40050	•	•	•	•
LEVITON IP710-LFZ	•	•	•	•
LEGRAND: ADPD4FBL3P2W4	•	•	•	•
<b>TRIAC DIMMING &amp; CONTROLS</b>				
LUTRON SKYLARK: S2-L-WH	•	•	•	•
LUTRON DIVA DVLV-600P-WH	•	•	•	•
LUTRON DIVA DVLV-603P-WH	•	•	•	•
LUTRON MAESTRO MALV-600-WH	•	•	•	•
LUTRON MAESTRO MALV-1000-WH	•	•	•	•
LUTRON MAESTRO MA-R-XX	•	•	•	•

- Flicker free dimming
- Aluminum casing for optimal heat dissipation
- Isolated output power per NEC and UL safety requirements
- UL & ETL recognized/ listed, meets UL 8750, 1310 requirements
- Auto-reset: short circuit, overload and thermal protection
- Class 2 power supply
- Efficient, High power factor > 0.90
- The Solid State Constant Voltage Uni-Power Supply is compatible with most commercially available Dimmers:
  - Triac Dimmer : (Forward Phase) Typically used for the dimming of Incandescent and Low Voltage Magnetic Transformers
  - ELV Dimmer : (Reverse Phase) Dimming of Electronic Low Voltage Transformers and Power Supply's used for LED lighting
  - 0-10 Dimmer : Dims the Low Voltage side of a 0-10 volt power supply commonly used in large scale lighting or commercial applications.
- The Uni-Power Supply is recommended with any Siemens/Murray brand of arc fault breaker to overcome the issues with tripping the breakers with an ELV LED Low Voltage Drivers.

PROJECT		FIXTURE TYPE		DATE	
---------	--	--------------	--	------	--

**IN WALL MOUNTING OPTIONS**

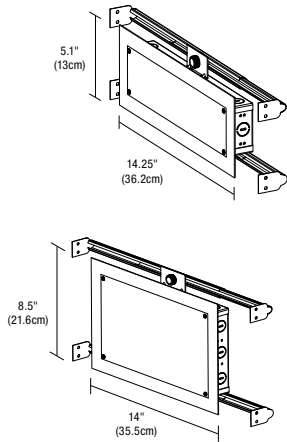

**In-Wall Mounting Kit:** Includes power supply, box cover and stud hangers for installing Junction Box in wall. Select "IW" in the options section of compatible power supply ordering codes if an In-Wall Mounting Kit is needed.

**Ordering Codes 5.1 x 14.25 inch:** PSB-40W-UNI-24VDC-IW  
PSB-60W-UNI-24VDC-IW  
PSB-96W-UNI-24VDC-IW

**Ordering Codes 8.5 x 14.25 inch:** PSB-2X40W-UNI-24VDC-IW  
PSB-2X60W-UNI-24VDC-IW  
PSB-2X96W-UNI-24VDC-IW

**WIRING DIAGRAMS UNIVERSAL POWER SUPPLY**

**Application:** Triac dimming for two power supplies, use for Static White, Dynamic/Tunable White 2000K-4000K

**Dimming:** Dimmable with Triac dimmer: Lutron: Skylark S2-L

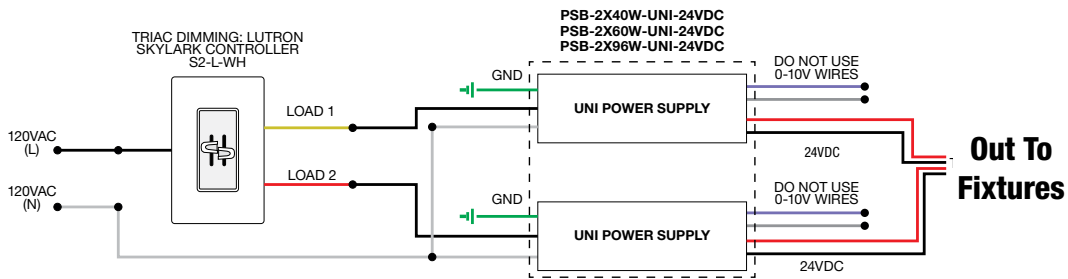

**Application:** ELV dimming for Static White and Warm Dim

**Dimming:** Dimmable with ELV dimmer: Legrand, Adorne ADTP703TU; Lutron: Diva DVELV-300P, Skylark SELV-300P, Maestro MAELV-600 and Radio Ra 2

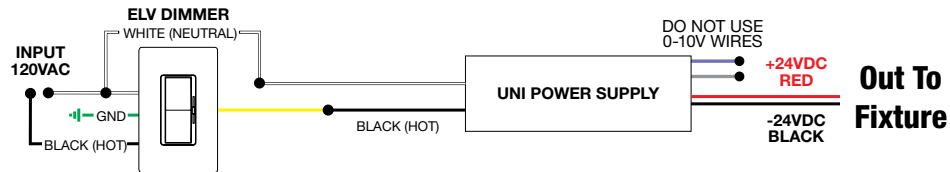

**Application:** 0-10V dimming for Static White

**Dimming:** Dimmable with 0-10V dimmer: Philips Sunrise: SR1200ZTUNV; Lutron Diva: DVTV-WH, DVSTV-WH; Lutron Nova T: NTSTV-DV-XX; Lutron Grafix EYE QS: QSGRJ-XP; Lutron Radio Ra2: RRD-10ND; Leviton: LEV40050; Leviton IP710-LFZ; Legrand: ADPD4FBL3P2W4

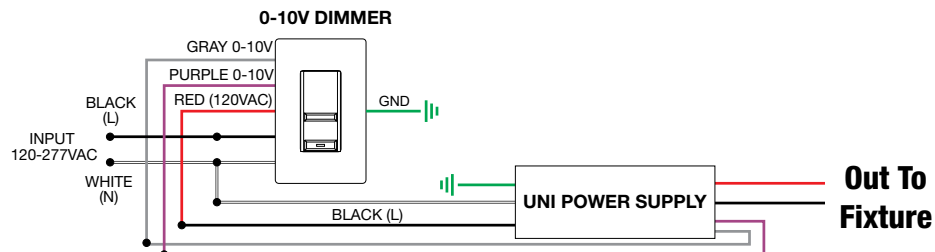

PROJECT		FIXTURE TYPE		DATE	
---------	--	--------------	--	------	--

LUTRON HI-LUME® PREMIER .1% ECOSYSTEM®†			
ORDERING CODES	L3D0-96W24V-U	2-WIRE ECOSYSTEM LTEA4U1UKL-CV240	3-WIRE ECOSYSTEM L3DA4U1UKL-CV240
SPECIFICATIONS			
MAXIMUM LOAD	96W	5W-40W	5W-40W
INPUT VOLTAGE	120-277VAC	120-277VAC	120-277VAC
OUTPUT VOLTAGE	24VDC	24VDC	24VDC
DIMENSIONS	10.5" X 5.5" X 2"	4" X 4.89" X 2.62"	4" X 4.89" X 2.62"
CLASSIFICATION	CLASS 2	CLASS 2	CLASS 2
DIMMING AND CONTROLS			
RADIO RA2	•	•	•
HOMEWORKS QS	•	•	•
PHPM-3F-120	•	•	•
PHPM-3F-DV	•	•	•
BCI-0-10	•	•	•

†24K - 57K color temperatures are compatible with 0-10V, ELV, and Lutron Hi-lume® Power Supplies. Warm Dim (27D, 30D) color temperatures are only compatible with ELV power supplies.

2-Wire EcoSystem Wiring Diagram

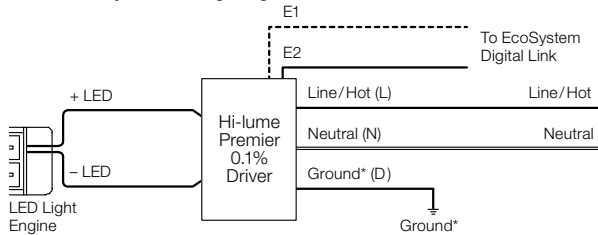

LTEA4U1UKL-CV240

3-Wire Wiring Diagram

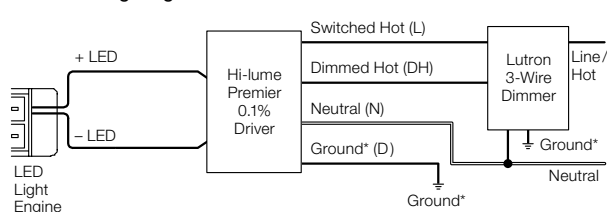

L3DA4U1UKL-CV240

PROJECT	FIXTURE TYPE	DATE
---------	--------------	------



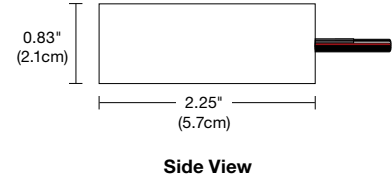
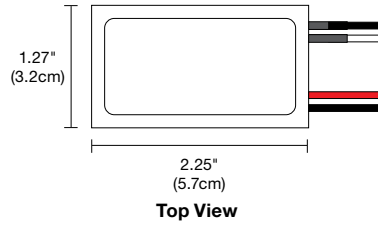
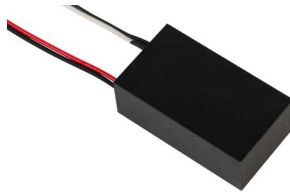

**DESCRIPTION**

Compact, lightweight remote electronic 60W/24V LED Power Supply\* converts standard 120VAC voltage to 24VDC and features built-in short-circuit protection. The low voltage output may be dimmed using an electronic low voltage dimmer. The Power Supply is certified to be used inside a standard Junction Box enclosure. Power Supply features short circuit and overload protection. Indoor applications only.

*\*Electrical Panels using Seimens/Murray AFCI breakers are not compatible with this ELV transformer. Use 0-10 Volt power supplies with this breaker.*

**APPLICATIONS**

Indoor\*  
 To avoid overheating the power supply, install it in a ventilated remote location where air flows. Maintain proper spacing among power supplies when multiple power supplies are installed in the same remote location.

- POWER INPUT** 120 volts AC, 60Hz
- POWER OUTPUT** Class 2; 24 volts DC 2.5A 60 watt maximum
- DIMENSIONS** 2.25" x 1.25" x 0.83"
- DIMMER TYPE** Electronic Low Voltage Dimmer Lutron: Diva #DVELV-300P; Skylark #SELV-300P; Maestro #MAELV-600

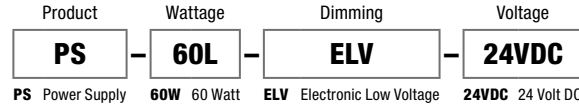
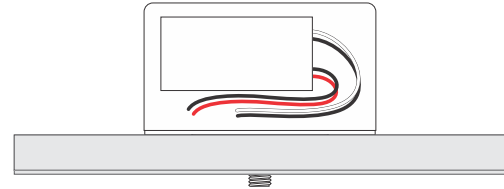

**SAMPLE WIRING DIAGRAMS 24VDC ELV**

- Application:** ELV dimming for Static White
- Dimming:** Dimmable with ELV dimmer: Legrand, Adorne ADTP703TU; Lutron: Diva DVELV-300P, Skylark SELV-300P, Maestro MAELV-600 and Radio Ra 2

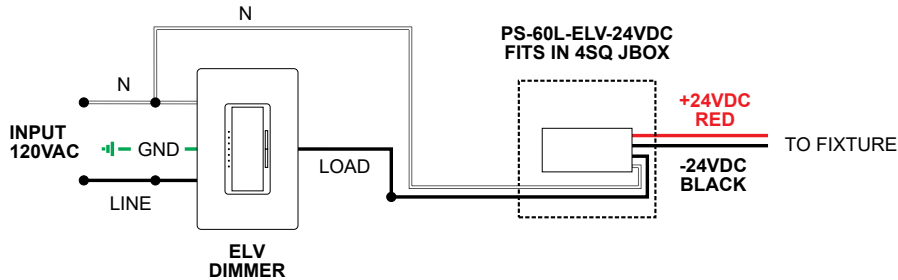

- Application:** Dual ELV dimming for Dynamic/Tunable White 2000K-4000K
- Dimming:** Dimmable with ELV dimmer: Legrand, Adorne ADTP703TU; Lutron: Diva DVELV-300P, Skylark SELV-300P, Maestro MAELV-600 and Radio Ra 2

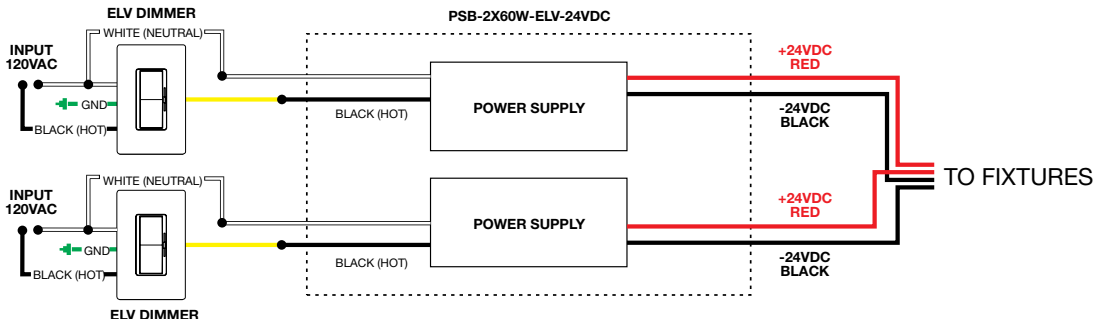

PROJECT	FIXTURE TYPE	DATE
---------	--------------	------



# WALL TM30 DATA

24VDC - PLASTER-IN LED SYSTEM, STATIC WHITE OR WARM DIM

**TM-30-15 DATA:** The data below is for SS5C and SS10C bare LED Soft Strips. Consistent color temperatures throughout a single strip and among multiple strips is possible through a 3 phase binning process in which each order is inspected with a color meter to ensure uniformity.

**2200K** | Rf: 83.9 | Rg: 94.9

Color Vector Graphic

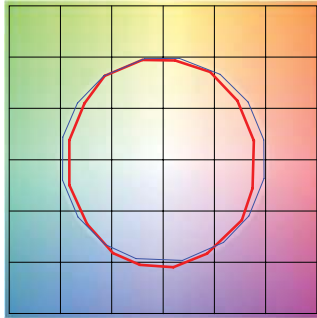

■ Test ■ Reference

GRAPHIC SHIFTS %			
HUE BIN	Rf	CHROMA	HUE
1	78.8	-9.5%	1.3%
2	80.7	-7.8%	6.7%
3	78.2	-3.3%	9.4%
4	89.7	-2.8%	3.6%
5	93.2	-0.8%	2.6%
6	93.0	-0.6%	-0.7%
7	87.7	-5.9%	-3.5%
8	89.2	-6.8%	1.9%
9	83.4	-5.6%	6.0%
10	79.3	-3.7%	10.8%
11	81.4	2.9%	11.1%
12	84.9	5.3%	4.9%
13	88.1	4.9%	-10.1%
14	68.1	0.1%	-19.5%
15	86.0	-3.3%	-7.3%
16	76.4	-8.9%	-11.7%

**2400K** | Rf: 91.2 | Rg: 96.8

Color Vector Graphic

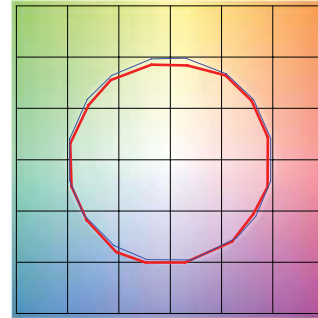

■ Test ■ Reference

GRAPHIC SHIFTS %			
HUE BIN	Rf	CHROMA	HUE
1	92.0	-2.4%	1.5%
2	94.7	-2.1%	0.0%
3	95.4	-1.9%	-0.1%
4	88.7	-6.7%	-3.1%
5	92.8	-5.6%	1.0%
6	92.7	-3.4%	3.4%
7	89.9	-4.3%	4.1%
8	92.4	-1.4%	4.4%
9	89.0	-0.6%	5.8%
10	88.9	0.4%	6.2%
11	89.7	4.0%	5.4%
12	92.6	3.0%	-0.7%
13	90.9	1.1%	-7.0%
14	89.9	0.5%	-5.8%
15	92.1	-3.2%	0.1%
16	88.9	-1.7%	-6.3%

**2700K** | Rf: 87.7 | Rg: 96.1

Color Vector Graphic

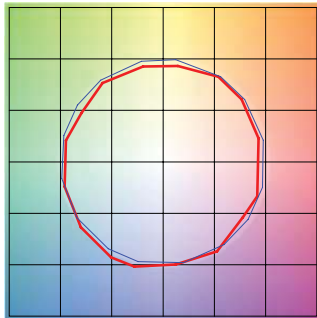

■ Test ■ Reference

GRAPHIC SHIFTS %			
HUE BIN	Rf	CHROMA	HUE
1	88.0	-4.3%	2.6%
2	91.6	-2.4%	2.0%
3	93.7	-1.4%	1.9%
4	88.9	-5.6%	-3.1%
5	92.3	-5.5%	-0.5%
6	92.9	-3.5%	0.1%
7	84.5	-7.5%	4.6%
8	90.8	-3.0%	4.4%
9	84.5	-1.3%	8.3%
10	83.9	2.0%	9.8%
11	87.2	5.3%	7.1%
12	89.2	5.4%	-2.6%
13	88.7	0.3%	-7.8%
14	86.8	1.7%	-9.3%
15	87.6	-5.4%	-1.3%
16	83.6	-3.3%	-9.5%

**3000K** | Rf: 88.1 | Rg: 99.7

Color Vector Graphic

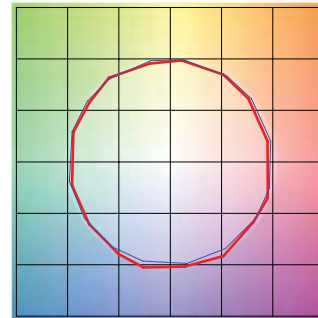

■ Test ■ Reference

GRAPHIC SHIFTS %			
HUE BIN	Rf	CHROMA	HUE
1	92.5	-3.1%	0.3%
2	93.3	-2.3%	1.9%
3	90.9	-0.8%	3.9%
4	94.3	-1.1%	1.4%
5	92.5	-2.6%	1.5%
6	96.4	1.2%	-0.3%
7	92.6	-2.5%	-0.0%
8	96.9	-1.4%	0.2%
9	92.3	-1.8%	4.3%
10	86.6	-0.7%	7.0%
11	86.5	2.4%	8.2%
12	89.8	5.9%	1.7%
13	93.9	2.6%	-2.7%
14	89.4	5.1%	-5.8%
15	90.1	-0.1%	-4.7%
16	86.5	0.3%	-9.7%

**3500K** | Rf: 86.1 | Rg: 95.5

Color Vector Graphic

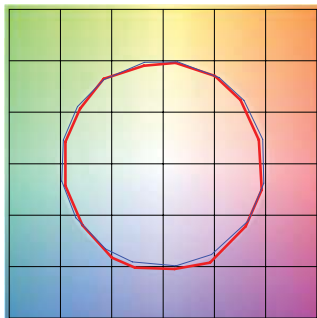

■ Test ■ Reference

GRAPHIC SHIFTS %			
HUE BIN	Rf	CHROMA	HUE
1	90.8	-3.8%	0.3%
2	92.3	-2.8%	2.1%
3	89.7	-1.0%	4.3%
4	92.6	-1.4%	1.7%
5	91.8	-3.1%	1.3%
6	96.2	0.8%	-0.4%
7	92.9	-3.2%	0.2%
8	94.3	-2.5%	1.5%
9	90.4	-2.5%	5.2%
10	84.3	-1.4%	9.5%
11	83.1	3.5%	9.8%
12	88.2	4.8%	3.4%
13	94.0	2.7%	-2.0%
14	88.7	5.9%	-5.8%
15	88.7	0.7%	-5.9%
16	86.8	-0.7%	-6.7%

**4000K** | Rf: 87.6 | Rg: 96.8

Color Vector Graphic

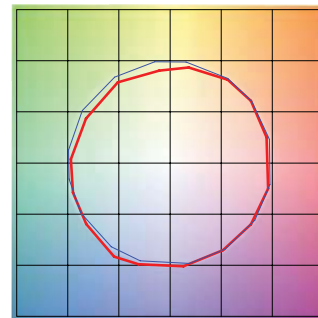

■ Test ■ Reference

GRAPHIC SHIFTS %			
HUE BIN	Rf	CHROMA	HUE
1	88.9	-2.4%	2.5%
2	93.3	-0.4%	0.8%
3	94.8	-1.0%	-0.6%
4	87.9	-4.9%	-3.6%
5	85.3	-9.4%	-2.6%
6	90.2	-6.0%	0.2%
7	85.3	-7.6%	4.6%
8	83.7	-4.1%	8.2%
9	79.5	-1.1%	13.8%
10	78.6	1.5%	12.1%
11	83.5	6.4%	7.8%
12	90.9	3.6%	-1.1%
13	88.3	1.7%	-6.3%
14	91.9	-0.4%	-2.2%
15	84.5	-0.9%	-5.5%
16	84.7	-1.1%	-4.4%

PROJECT	FIXTURE TYPE	DATE
---------	--------------	------

# WALL TM30 DATA

24VDC - PLASTER-IN LED SYSTEM, STATIC WHITE OR WARM DIM

**TM-30-15 DATA:** The data below is for SS5C and SS10C bare LED Soft Strips. Consistent color temperatures throughout a single strip and among multiple strips is possible through a 3 phase binning process in which each order is inspected with a color meter to ensure uniformity.

**5700K** | Rf: 80.3 | Rg: 91.5

Color Vector Graphic

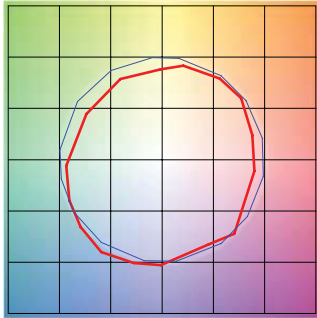

■ Test ■ Reference

HUE BIN	Rf	GRAPHIC SHIFTS %	
		CHROMA	HUE
1	75.4	-8.9%	4.7%
2	87.5	-2.6%	4.6%
3	90.7	-3.0%	-0.5%
4	83.2	-6.0%	-5.7%
5	76.2	-12.9%	-5.3%
6	81.4	-11.9%	-2.6%
7	74.8	-14.0%	5.1%
8	69.0	-9.0%	14.1%
9	72.6	-3.6%	22.2%
10	71.4	2.7%	16.1%
11	81.3	7.9%	5.3%
12	83.6	4.1%	-9.4%
13	78.4	0.7%	-15.3%
14	77.7	-6.2%	-11.0%
15	68.8	-1.3%	-21.2%
16	80.8	-9.6%	3.3%

**2700D** | Rf: 89.5 | Rg: 100.8

Color Vector Graphic

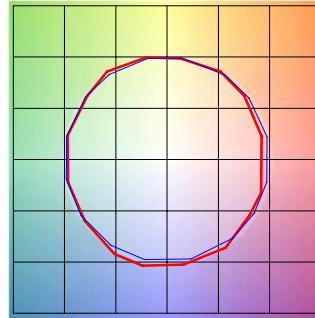

■ Test ■ Reference

HUE BIN	Rf	GRAPHIC SHIFTS %	
		CHROMA	HUE
1	88.8	-5.1%	1.4%
2	89.8	-2.7%	4.1%
3	87.2	0.3%	5.9%
4	92.3	-0.9%	1.0%
5	93.3	1.5%	1.7%
6	92.4	3.6%	-0.2%
7	92.2	-0.9%	-2.4%
8	96.7	-0.4%	-1.1%
9	92.3	-1.2%	3.7%
10	88.9	-0.0%	6.1%
11	86.4	5.1%	7.4%
12	88.2	6.3%	-0.9%
13	87.2	3.8%	-8.1%
14	84.2	3.8%	-11.0%
15	89.8	-2.6%	-4.3%
16	82.7	-3.4%	-11.1%

**3000D** | Rf: 89.8 | Rg: 101.4

Color Vector Graphic

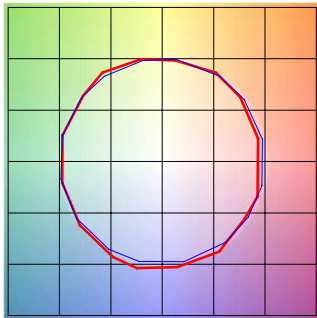

■ Test ■ Reference

HUE BIN	Rf	GRAPHIC SHIFTS %	
		CHROMA	HUE
1	90.2	-4.2%	1.5%
2	90.9	-2.0%	3.7%
3	87.9	0.8%	5.5%
4	92.1	-0.9%	0.6%
5	93.0	1.5%	1.6%
6	92.2	3.9%	-0.2%
7	92.1	-0.3%	-2.0%
8	96.7	0.0%	-1.2%
9	92.5	-0.6%	3.7%
10	88.3	1.1%	7.0%
11	87.2	4.1%	7.4%
12	87.2	6.7%	-1.0%
13	88.2	3.8%	-7.2%
14	85.3	4.3%	-9.9%
15	90.9	-2.2%	-3.6%
16	83.4	-2.2%	-11.2%

PROJECT	FIXTURE TYPE	DATE
---------	--------------	------