

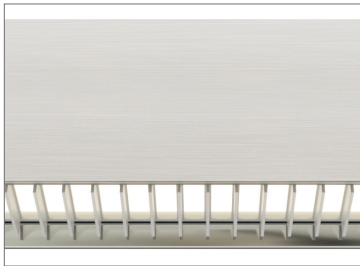

Diffused White Lens Shown without Louver

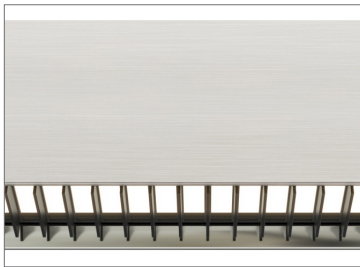

Diffused White Lens Shown with White Louver



Diffused White Lens Shown with Black Louver



Description

With the combination of clean, linear channels that create a geometric shape, the Nova Large Down MiYO (Make-It-Your-Own) Square LED Suspension is as minimalist as it is futuristic in design. The Square MiYO is available in 5 or 7 watts per foot and features a diffused flat lens with a 100° spread. The LED strip light is available in 85+ or 92+ CRI and can be ordered in various lengths, from 14" to 84" squares. An optional white or black louver is available to help reduce glare. On smaller sizes (less than 34" for 5w and 20" for 7w), a flush 4.6" round canopy is supplied. For larger sizes, Tunable White, and/or if adding a Fast Jack port in the center of the canopy, an 8.5" surface canopy is included. The Fast Jack Connector option in the canopy allows the addition of a pendant or a track head so that you can accent any art work for your unique design. Available in 22K to 57K, Warm Dim, and Tunable White Options.

Finishes

Available in Satin Nickel, White, Chrome and Black finishes with Satin Nickel hardware. Satin Brass finish comes with Black connectors, caps and canopy.

Applications

Designed for indoor use only. Ideal environments include: conference rooms, kitchens, dining rooms, architectural lighting, general lighting, and retail.

Lenses

- Available in a Diffused White Lens with 100° beam spread
- Optional black or white louver available

Lamp

- Choose from 9 color temperatures from 2200K-5700K including Warm Dim and Tunable White
- Warm Dim: 2700K to 2000K (27D) or 3000K to 2000K (30D)
- Tunable White 2000K-4000K
- 50,000 Hour Lamp Life

Power Supply (included in canopy)

- 2 x 120V input, 24VDC Class 2 output; electronic low voltage LED power supplies
- FJ port electronic low voltage power supply 12V

Dimming

- Dimmable with ELV dimmer: Legrand, Adorne ADTP703TU; Lutron: Diva DVELV-300P, Skylark SELV-300P, Maestro MAELV-600 and Radio Ra 2

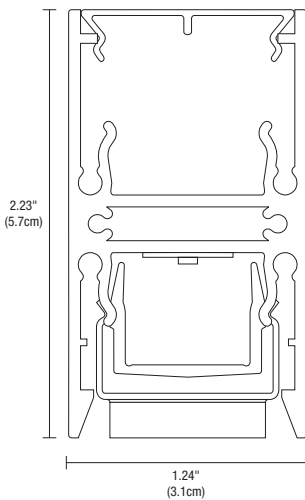

Shown with louver (Actual Size)

System	Canopy	Wattage Per Foot	Canopy	Nominal Size	Color Temperature	Finish
NSLDP	SQ	7W	C	14	22K	SN
NSLDP Nova Suspension Large Down MiYO Diffused lens, Power NSLDWP Nova Suspension Large Down MiYO Diffused Lens with White louver, Power NSLDBP Nova Suspension Large Down MiYO Diffused Lens with Black louver, Power	SQ Square SQF Square with Fast Jack (center feed canopy only)	5W 5 Watt, Tunable White & Warm Dim 7W 7 Watt, Cold Dim	C Center E End Feed	22K - 57K & 2K4K Sizes: 14, 17, 19, 24, 29, 36, 41, 48, 60 (Maximum length for 7 watt), 72, 84 (Maximum length for 5 watt) 27D, 30D Warm Dim Sizes: 14, 17, 20, 23, 29, 35, 41, 47, 59, 71, 83 *See length chart for exact dimensions (pg. 4)	22K 2200K Amber White 27K 2700K Very Warm White 27D 2700K Warm Dim (5W only) 30K 3000K Warm White 30D 3000K Warm Dim (5W only) 35K 3500K Neutral White 40K 4000K Cool White 57K 5700K Daylight White 2K4K 2000K-4000K Tunable White (5W only)	SN Satin Nickel BK Black WH White CH Chrome SB Satin Brass* *Includes Black Connectors

PROJECT	FIXTURE TYPE	DATE
---------	--------------	------

NOVA LARGE DOWN MIYO (MAKE IT YOUR OWN) SQUARE WARM DIM LED SUSPENSION WITH POWER

REV.05.01.18

DESIGNED BY GREGORY KAY | ASSEMBLED IN AMERICA

Finishes: Finishes available for the Nova Large Down MiYO Square LED Suspension fixture

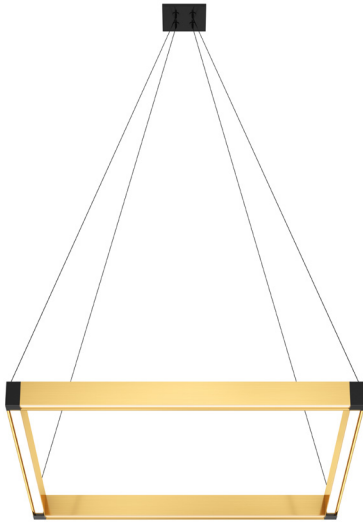

NSLDP-SQ-5W-C-18-22K-SB

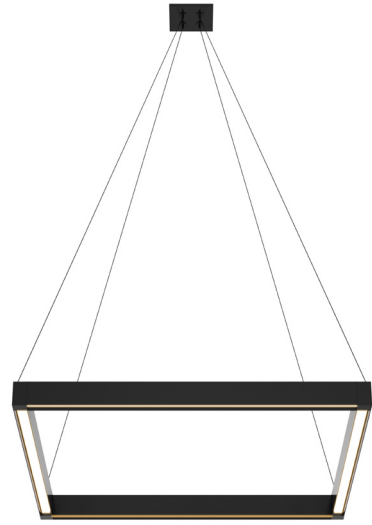

NSLDP-SQ-5W-C-18-22K-BK



NSLDP-SQ-5W-C-18-22K-CH



NSLDP-SQ-5W-C-18-22K-SN



NSLDP-SQ-5W-C-18-22K-WH

PROJECT		FIXTURE TYPE		DATE	
---------	--	--------------	--	------	--

NOVA LARGE DOWN MIYO (MAKE IT YOUR OWN) SQUARE WARM DIM LED SUSPENSION WITH POWER

REV.05.01.18

DESIGNED BY GREGORY KAY | ASSEMBLED IN AMERICA

Lamp Data: Lamp data for the Nova Large Down MiYO Square LED Suspension fixture

NSLDP														
100 Degree Diffused White Lens without Louver														
DESCRIPTION	5w (4.4 watts)							7w (7.3 watts)						
WATTS PER FOOT														
COLOR TEMPERATURE	22K	27K	27D*	30K	30D*	35K	40K	57K	22K	27K	30K	35K	40K	57K
LUMENS PER FOOT (lm/ft)	173	211	236	231	259	264	287	306	307	374	409	469	509	542
LUMENS PER WATT (lm/w)	39	48	49	52	54	60	65	69	42	51	56	64	70	74
CRI	85+	95+	95+	95+	95+	85+	84	84	85+	95+	95+	85+	84	84

NSLDWP														
100 Degree Diffused White Lens with White Louver														
DESCRIPTION	5w (4.4 watts)							7w (7.3 watts)						
WATTS PER FOOT														
COLOR TEMPERATURE	22K	27K	27D*	30K	30D*	35K	40K	57K	22K	27K	30K	35K	40K	57K
LUMENS PER FOOT (lm/ft)	143	174	218	190	238	218	237	252	253	309	338	387	420	448
LUMENS PER WATT (lm/w)	32	40	45	43	50	50	54	57	35	42	46	53	58	61
CRI	85+	95+	95+	95+	95+	85+	84	84	85+	95+	95+	85+	84	84

NSLDBP														
100 Degree Diffused White Satin Lens with Black Louver														
DESCRIPTION	5w (4.4 watts)							7w (7.3 watts)						
WATTS PER FOOT														
COLOR TEMPERATURE	22K	27K	27D*	30K	30D*	35K	40K	57K	22K	27K	30K	35K	40K	57K
LUMENS PER FOOT (lm/ft)	82	101	139	110	152	126	137	146	146	178	195	223	243	258
LUMENS PER WATT (lm/w)	19	23	29	25	32	29	31	33	20	24	27	31	33	35
CRI	85+	95+	95+	95+	95+	85+	84	84	85+	95+	95+	85+	84	84

*27D, 30D - Warm Dim (4.8 Watts)

Nova Downlight 5 Watt 100°	
Distance	Foot Candles
1'	152
1.5'	100
2'	74
3'	47
4'	34
5'	25
6'	20
7'	15
8'	13

Nova Downlight 7 Watt 100°	
Distance	Foot Candles
1'	251
1.5'	165
2'	121
3'	79
4'	57
5'	43
6'	34
7'	27
8'	23

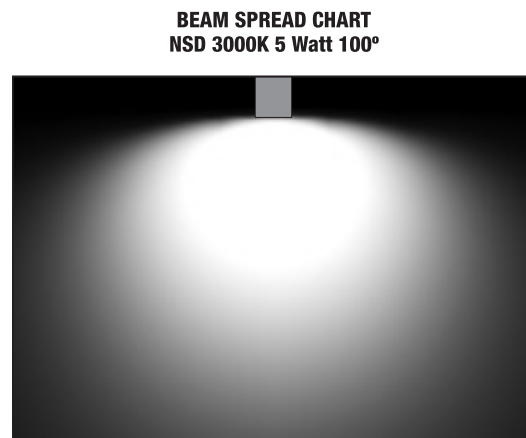
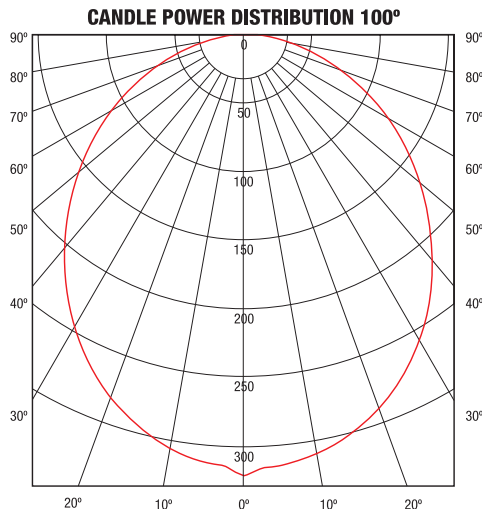

PROJECT	FIXTURE TYPE	DATE
---------	--------------	------

NOVA LARGE DOWN MIYO (MAKE IT YOUR OWN) SQUARE WARM DIM LED SUSPENSION WITH POWER

REV.05.01.18

DESIGNED BY GREGORY KAY | ASSEMBLED IN AMERICA

Length Chart: Actual lengths for Nova Large Down MiYO Square LED Suspension with Power

22K, 27K, 30K, 35K, 40K, 57K & 2K4K											
Nominal Length A (Inches)	Dim A (Inches)	Total Wattage (5W)	Canopy (5W)	Total Lumens 3000K (5W)	Total Lumens White Louver (5W)	Total Lumens Black Louver (5W)	Total Wattage (7W)	Canopy (7W)	Total Lumens 3000K (7W)	Total Lumens White Louver (7W)	Total Lumens Black Louver (7W)
14	14.350	20	4" Round Flush	1072	752	472	28	4" Round Flush	1704	1192	748
17	16.750	24	4" Round Flush	1286	902	566	34	4" Round Flush	2045	1430	898
19	19.150	28	4" Round Flush	1501	1053	661	39	4" Round Flush	2386	1669	1047
24	23.950	36	4" Round Flush	1930	1354	850	50	4" Round Flush	3067	2146	1346
29	28.750	44	4" Round Flush	2358	1654	1038	62	8" Surface	3749	2622	1646
36	35.950	56	8" Surface	3002	2106	1322	78	8" Surface	4771	3338	2094
41	40.750	64	8" Surface	3430	2406	1510	90	8" Surface	5453	3814	2394
48	47.950	76	8" Surface	4074	2858	1794	106	8" Surface	6475	4530	2842
60	59.950	96	8" Surface	5146	3610	2266	126	8" Surface	7583	5572	3580
72	71.950	116	8" Surface	6218	4362	2738					
84	83.950	136	8" Surface	7290	5114	3210					

WARM DIM (27D & 30D)						
Nominal Length A (Inches)	Dim A (Inches)	Total Wattage (5W)	Canopy (5W)	Total Lumens 3000K (5W)	Total Lumens White Louver (5W)	Total Lumens Black Louver (5W)
14	14.350	20	4" Round Flush	1320	924	580
17	17.350	25	4" Round Flush	1650	1155	725
20	20.350	30	4" Round Flush	1980	1386	870
23	23.350	35	4" Round Flush	2310	1617	1015
29	29.350	45	4" Round Flush	2970	2079	1305
35	35.350	55	8" Surface	3630	2541	1595
41	41.350	65	8" Surface	4290	3003	1885
47	47.350	75	8" Surface	4950	3465	2175
59	59.350	95	8" Surface	6270	4389	2755
71	71.350	115	8" Surface	7590	5313	3335
83	83.350	135	8" Surface	8910	6237	3915

PROJECT		FIXTURE TYPE		DATE	
---------	--	--------------	--	------	--

NOVA LARGE DOWN MIYO (MAKE IT YOUR OWN) SQUARE WARM DIM LED SUSPENSION WITH POWER

REV.05.01.18 DESIGNED BY GREGORY KAY | ASSEMBLED IN AMERICA

Drawings: Dimension drawings for the Nova Large Down MiYO Square LED Suspension fixture, Center Feed

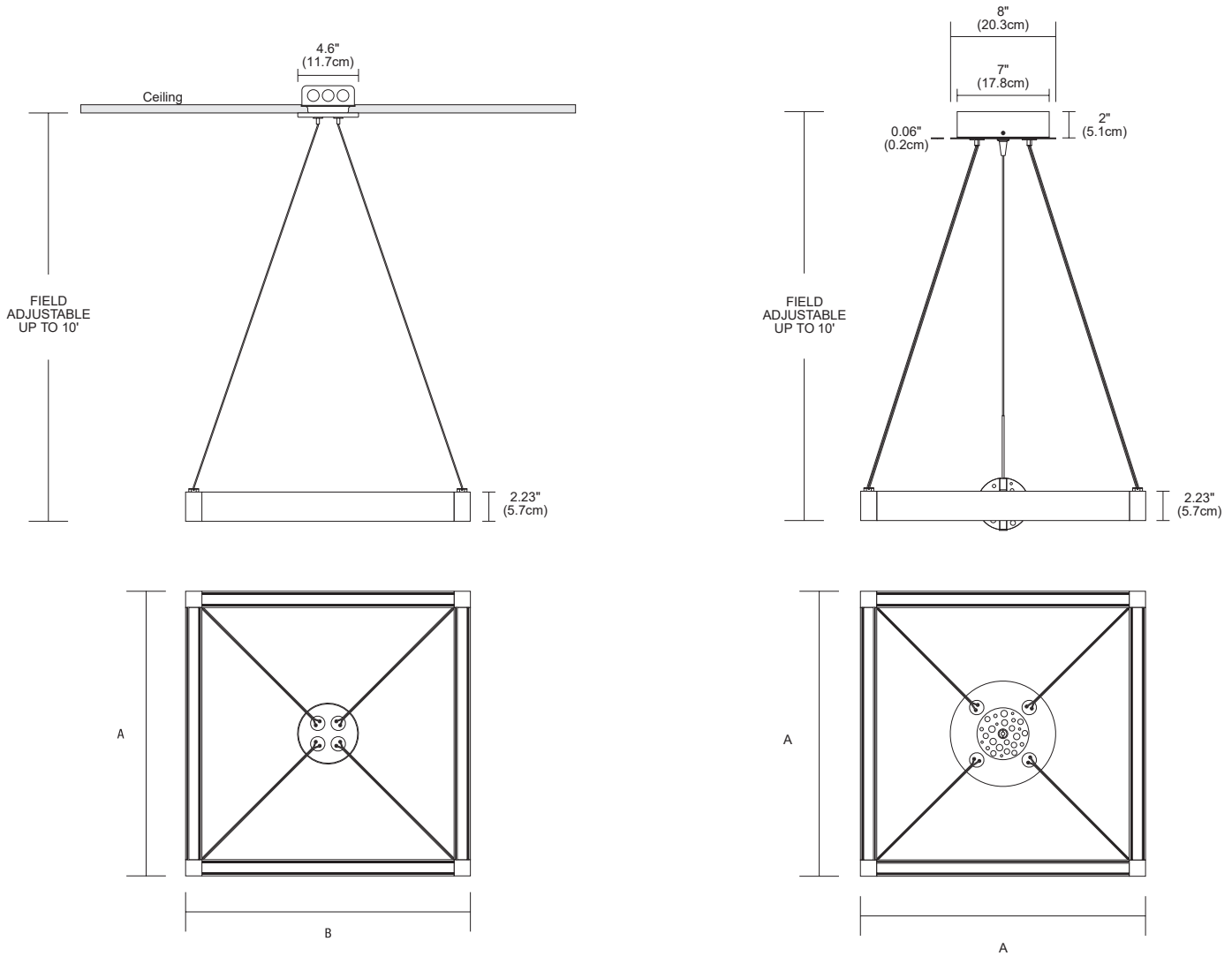

Drawings: Dimension drawings for the Nova Large Down MiYO Square LED Suspension fixture, End Feed

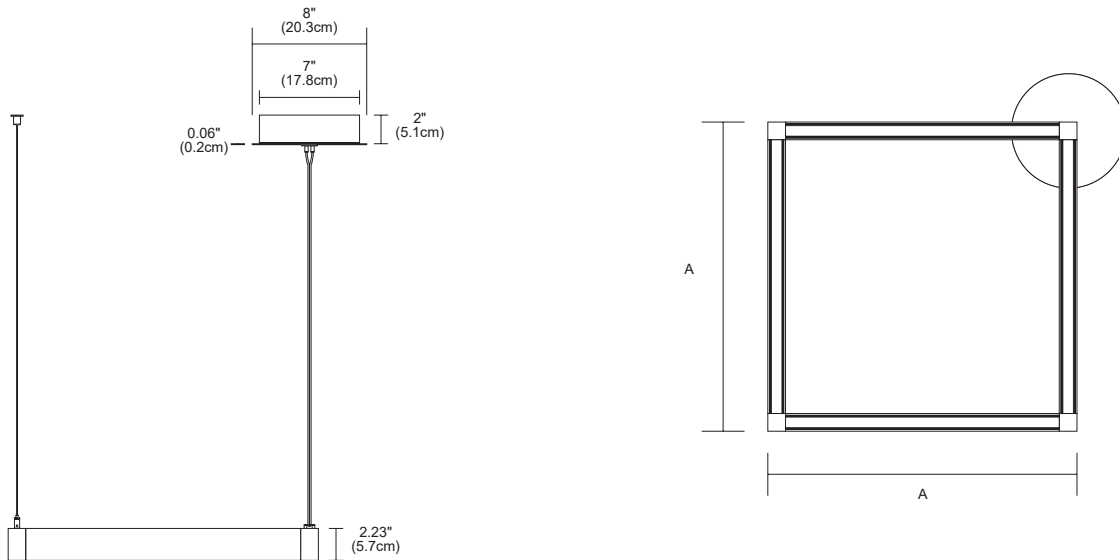

PROJECT	FIXTURE TYPE	DATE
---------	--------------	------

NOVA LARGE DOWN MIYO (MAKE IT YOUR OWN) SQUARE WARM DIM LED SUSPENSION WITH POWER

REV.05.01.18 DESIGNED BY GREGORY KAY | ASSEMBLED IN AMERICA

Wiring Diagram: Wiring diagram for Static White with ELV Dimmer

Application: ELV dimming for Nova Large Down MiYO Square LED Power Suspension, Center Feed Canopy, Static White

Dimming: Dimmable with ELV dimmer: Legrand, Adorne ADTP703TU;
Lutron: Diva DVELV-300P, Skylark SELV-300P, Maestro MAELV-600 and Radio Ra 2

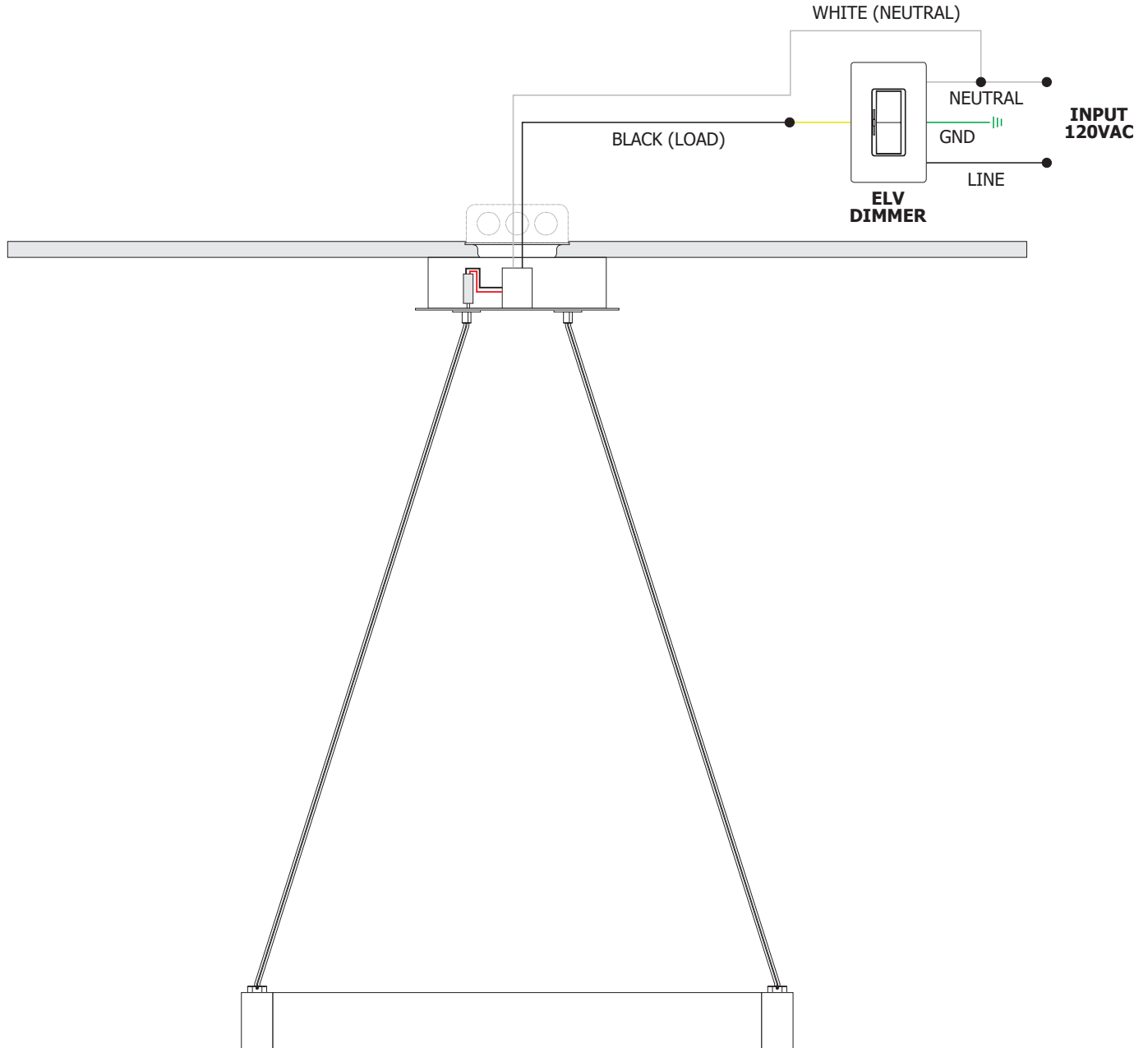

PROJECT		FIXTURE TYPE		DATE	
---------	--	--------------	--	------	--

NOVA LARGE DOWN MIYO (MAKE IT YOUR OWN) SQUARE WARM DIM LED SUSPENSION WITH POWER

REV.05.01.18 DESIGNED BY GREGORY KAY | ASSEMBLED IN AMERICA

Wiring Diagram: Wiring diagram for Tunable White with Dual ELV Dimmers

Application: ELV dimming for Nova Large Down MiYO Square LED Power Suspension, Center Feed Canopy, Tunable White 2000K - 4000K

Dimming: Dimmable with ELV dimmer: Legrand, Adorne ADTP703TU;
Lutron: Diva DVELV-300P, Skylark SELV-300P, Maestro MAELV-600 and Radio Ra 2

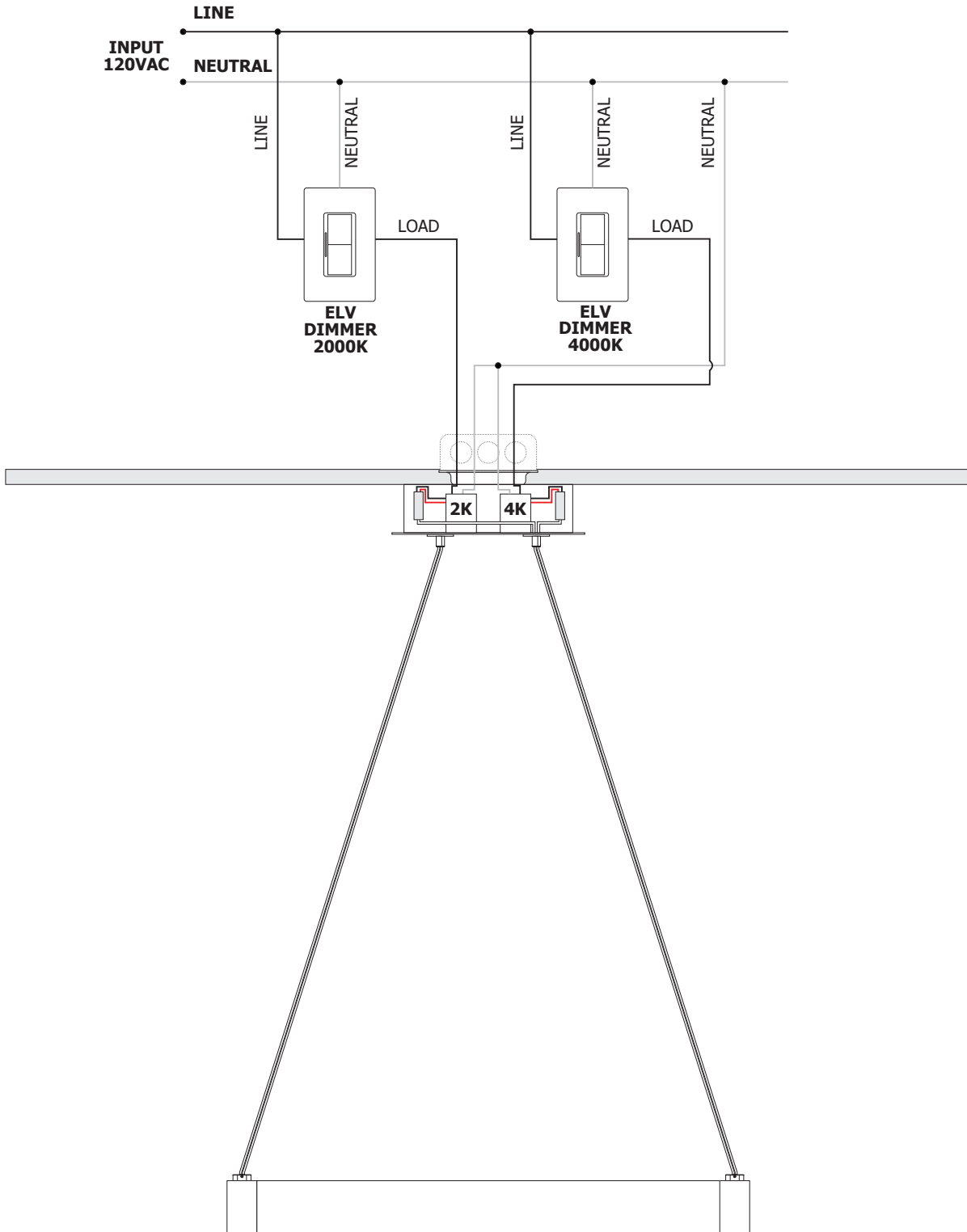

PROJECT		FIXTURE TYPE		DATE	
---------	--	--------------	--	------	--

NOVA LARGE DOWN MIYO (MAKE IT YOUR OWN) SQUARE WARM DIM LED SUSPENSION WITH POWER

REV.05.01.18 DESIGNED BY GREGORY KAY | ASSEMBLED IN AMERICA

Wiring Diagram: Wiring diagram for Static White with dual ELV Dimmers

Application: ELV dimming for Nova Large Down MiYO Square LED Power Suspension, Center Feed with Fast Jack, Static White

Dimming: Dimmable with ELV dimmer: Legrand, Adorne ADTP703TU;
Lutron: Diva DVELV-300P, Skylark SELV-300P, Maestro MAELV-600 and Radio Ra 2

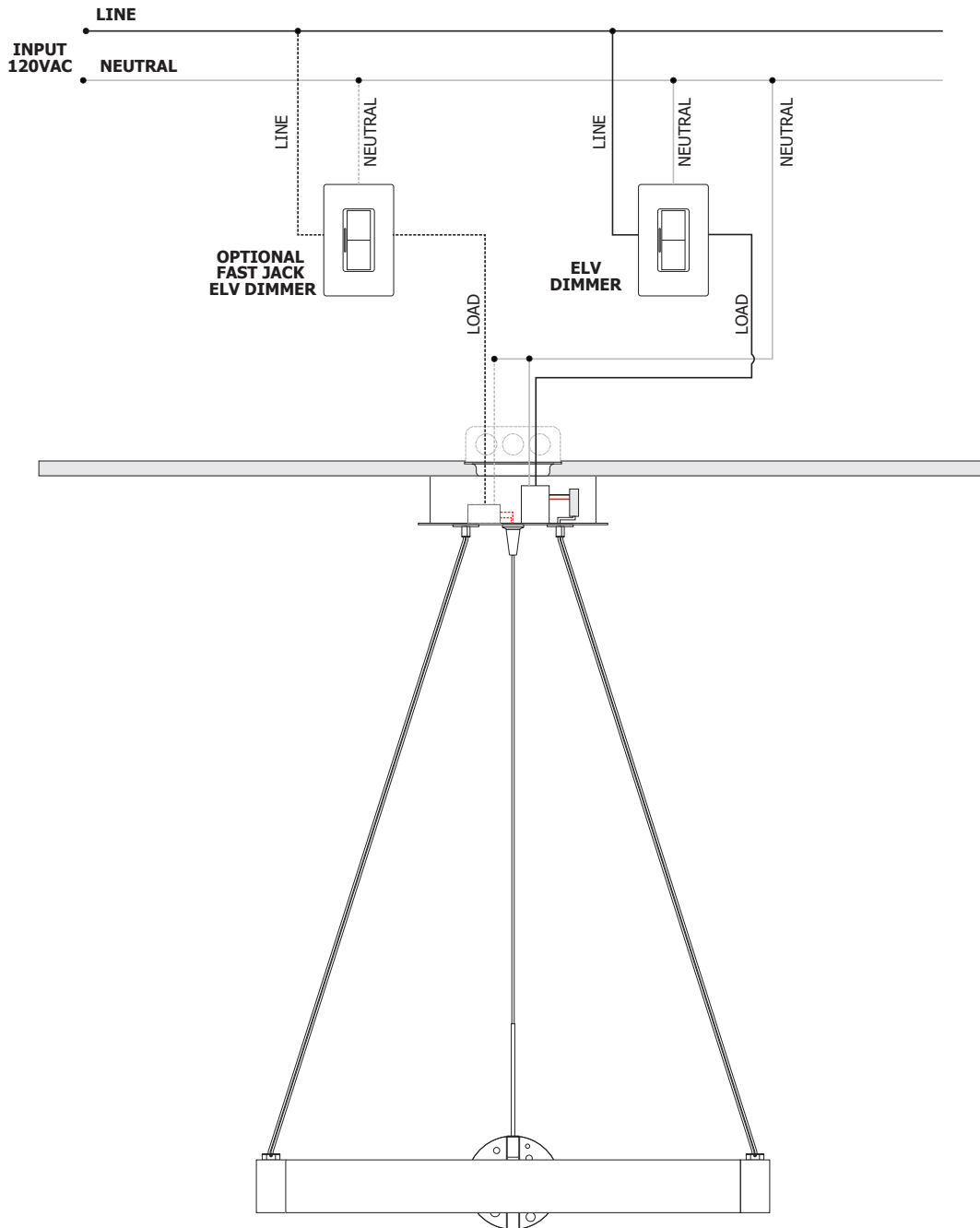

PROJECT	FIXTURE TYPE	DATE
---------	--------------	------

NOVA LARGE DOWN MIYO (MAKE IT YOUR OWN) SQUARE WARM DIM LED SUSPENSION WITH POWER

REV.05.01.18

DESIGNED BY GREGORY KAY | ASSEMBLED IN AMERICA

Wiring Diagram: Wiring diagram for Static White with ELV Dimmer

Application: ELV dimming for Nova Large Down MiYO Square LED Power Suspension, End Feed Canopy, Static White

Dimming: Dimmable with ELV dimmer: Legrand, Adorne ADTP703TU;
Lutron: Diva DVELV-300P, Skylark SELV-300P, Maestro MAELV-600 and Radio Ra 2

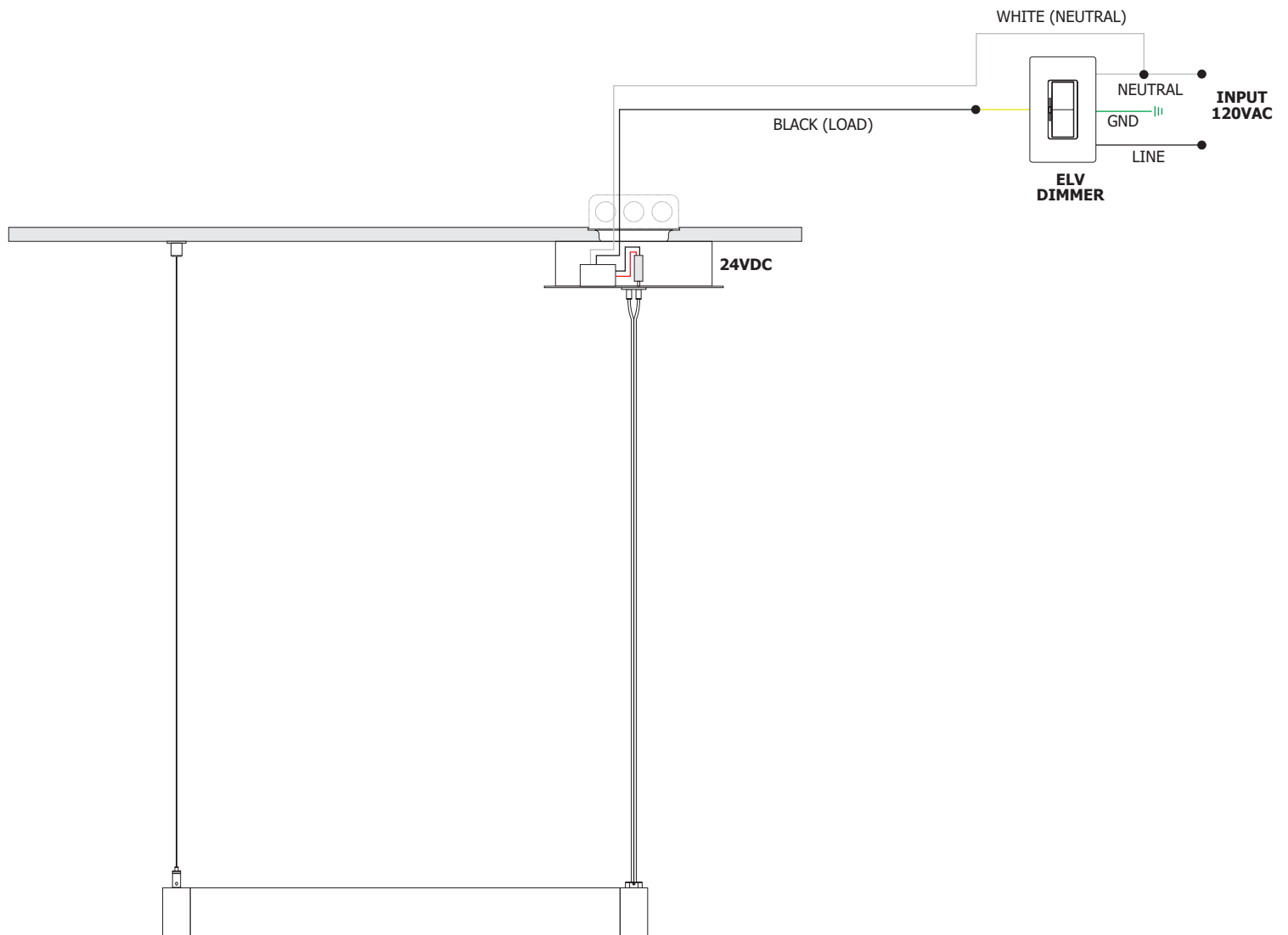

PROJECT		FIXTURE TYPE		DATE	
---------	--	--------------	--	------	--

NOVA LARGE DOWN MIYO (MAKE IT YOUR OWN) SQUARE WARM DIM LED SUSPENSION WITH POWER

REV.05.01.18

DESIGNED BY GREGORY KAY | ASSEMBLED IN AMERICA



FJ-SCO-1-PN
Fast Jack Scope LED
9W, 315 lumens 3000K
(adjustable beam spread
from 20°-50°)
Fixture Finishes: SN, PN, BZ, WH



FJ-PST-SP-1-30K-SN
Fast Jack Piston
9W, 650 lumens
SP 15°, NF 25°, FL 35°
& WF 45° Beam Spreads
Fixture Finishes: SN, PN, WH



FJ-FOR-SQ-3-PN
FJ-FOR-RD-3-PN
Fast Jack Form Round or Square
Fixture Finishes: SN, PN



FJ-FOR-2RD-3-SN
FJ-FOR-2SQ-3-SN
Fast Jack Form
Round or Square 2-Head
Fixture Finishes: SN, PN



FJ-REB-1-PN
Fast Jack Rebel
Fixture Finishes: SN, PN, BZ, WH



FJ-CHO-1-SN
Fast Jack Chopper with LED
Fixture Finishes: SN, PN, BZ



FJ-SPI-3-PN with S1-PN
Fast Jack Spirit, S1 Shade
Fixture Finishes: SN, PN, BZ
S1 Shade Finishes: SN, PN, BZ, BK



FJ-LOW-1-SN with S1-SN
Fast Jack Low Rider, S1 Shade
Fixture Finishes: SN, PN, BZ
S1 Shade Finishes: SN, PN, BZ, BK

FAST JACK FIXTURE & SHADE FINISHES

SN Satin Nickel	PN Polished Nickel	BZ Antique Bronze	WH White	BK Black
------------------------	---------------------------	--------------------------	-----------------	-----------------

2700K MR16 12V LED LAMPS

BRAND	SORAA			TCP		GREEN CREATIVE		
ORDERING CODE	SMT16-07-10D-927-03	SMT16-09-25D-927-03	SMT16-09-36D-927-03	LED712VMR16927KNFL	LED712VMR16927KFL	7.5MR16G4DIM/927SP15	7.5MR16G4DIM/927NF25	7.5MR16G4DIM/927FL36
CRI	95	95	95	92	92	92	92	92
BEAM ANGLE (DEGREES)	10	25	36	20	40	15	25	36
TOTAL LUMENS	390	465	465	425	425	410	485	485
LUMENS PER WATT	52	52	52	61	61	55	63	63
HALOGEN EQUIVALENT	50	60	60	50	50	75	75	75

3000K MR16 12V LED LAMPS

BRAND	SORAA			TCP		GREEN CREATIVE		
ORDERING CODE	SMT16-07-10D-930-03	SMT16-09-25D-930-03	SMT16-09-36D-930-03	LED712VMR16930KNFL	LED712VMR16930KFL	7.5MR16G4DIM/930SP15	7.5MR16G4DIM/930NF25	7.5MR16G4DIM/930FL36
CRI	95	95	95	92	92	92	92	92
BEAM ANGLE (DEGREES)	10	25	36	20	40	15	25	36
TOTAL LUMENS	410	490	490	425	425	430	505	505
LUMENS PER WATT	55	54	54	61	61	57	66	66
HALOGEN EQUIVALENT	50	60	60	50	50	75	75	75

PROJECT	FIXTURE TYPE	DATE
---------	--------------	------

NOVA LARGE DOWN MIYO (MAKE IT YOUR OWN) SQUARE WARM DIM LED SUSPENSION WITH POWER

REV.05.01.18

Pendants: Various Pendants available for the Nova Large Down MiYO Fast Jack with 12Volt Lamps



FJ-DROP2-12-SN WITH S1-SN
Fast Jack Drop 2
Fixture Finishes: SN



FJ-BBCL-10FT-12-SN
Fast Jack Bubble Ball
Fixture Finishes: SN



FJ-EVE-PL-12-SN
Fast Jack Everest
Color: Clear(CL), Platinum(PL)
Fixture Finishes: SN, PN, BZ



FJ-TOL-CS-12-SN-TCRY
Fast Jack Tower of Crystal Love
Color: Clear Satin Frost(CS)
Fixture Finishes: SN, PN, BZ



FJ-ICE-12-SN
Fast Jack Ice
Fixture Finishes: SN, PN, BZ



FJ-K2-12-SN
Fast Jack K2
Fixture Finishes: SN



FJ-LPIP-12-SN
Fast Jack LED Pipe
Fixture Finishes: SN



FJ-SALUTI-LG-L1-CR-SN
Fast Jack Saluti
Size: 3"(SM), 4"(MD), 5.5"(LG)
Glass Color: Cristallo(CR), Gray(GY)
Fixture Finishes: SN, PN, BZ



FJ-SCLP-12-SN
Fast Jack Scope LED
Fixture Finishes: SN, PN, BZ

Lamps included with all pendants shown above
For more lamp data see product spec sheets on www.PureEdgeLighting.com

PROJECT		FIXTURE TYPE		DATE	
---------	--	--------------	--	------	--

NOVA LARGE DOWN MIYO (MAKE IT YOUR OWN) SQUARE WARM DIM LED SUSPENSION WITH POWER

REV.05.01.18

TM-30-15 DATA: The data below is for SS2C, SS5C, SS7C, and SS10C bare LED Soft Strips. Consistent color temperatures throughout a single strip and among multiple strips is possible through a 3 phase binning process in which each order is inspected with a color meter to ensure uniformity.

2200K | Rf: 83.9 | Rg: 94.9

COLOR VECTOR GRAPHIC

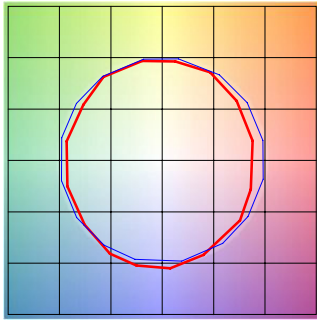

■ Test ■ Reference

HUE BIN	Rf	GRAPHIC SHIFTS %	
		CHROMA	HUE
1	77.6	-10.0%	1.8%
2	80.7	-7.5%	7.0%
3	79.5	-2.9%	8.9%
4	90.5	-3.1%	2.4%
5	93.9	-1.3%	1.9%
6	91.9	-0.9%	-0.2%
7	87.6	-6.3%	-2.7%
8	90.5	-5.4%	2.7%
9	83.8	-4.7%	6.5%
10	81.2	-2.5%	10.0%
11	83.3	3.9%	9.4%
12	86.4	5.6%	2.6%
13	86.2	4.5%	-12.4%
14	64.3	-1.0%	-21.9%
15	85.1	-4.4%	-7.5%
16	75.0	-9.9%	-12.0%

2700K | Rf: 87.7 | Rg: 96.1

COLOR VECTOR GRAPHIC

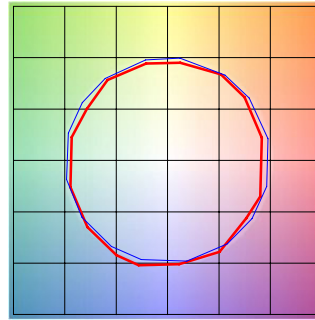

■ Test ■ Reference

HUE BIN	Rf	GRAPHIC SHIFTS %	
		CHROMA	HUE
1	86.4	-5.6%	2.3%
2	89.7	-3.3%	3.1%
3	90.5	-1.5%	3.8%
4	90.0	-4.3%	1.1%
5	92.9	-3.7%	0.2%
6	93.5	-2.5%	-0.8%
7	86.3	-7.2%	2.5%
8	90.7	-4.0%	3.2%
9	85.2	-2.4%	8.1%
10	81.7	0.9%	10.8%
11	85.4	4.5%	8.9%
12	88.7	5.7%	-1.4%
13	88.3	1.3%	-7.9%
14	85.1	2.4%	-10.4%
15	88.1	-4.8%	-2.7%
16	81.7	-4.3%	-10.9%

3000K | Rf: 88.1 | Rg: 99.7

COLOR VECTOR GRAPHIC

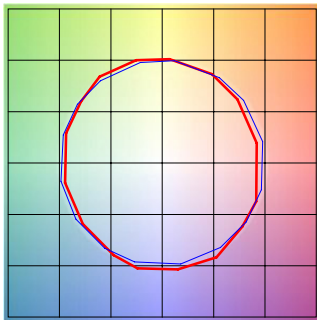

■ Test ■ Reference

HUE BIN	Rf	GRAPHIC SHIFTS %	
		CHROMA	HUE
1	87.7	-5.9%	-0.3%
2	87.9	-4.4%	4.3%
3	82.9	-1.2%	7.9%
4	89.9	0.6%	4.7%
5	92.7	3.0%	3.5%
6	92.7	3.6%	-1.7%
7	90.8	-1.3%	-4.4%
8	93.7	-2.5%	-2.2%
9	91.7	-3.7%	2.3%
10	85.5	-2.8%	7.8%
11	83.3	0.7%	11.0%
12	86.4	5.5%	3.8%
13	90.6	4.6%	-3.6%
14	85.6	5.9%	-8.4%
15	89.5	-0.6%	-5.7%
16	82.6	-2.7%	-12.0%

3500K | Rf: 86.1 | Rg: 95.5

COLOR VECTOR GRAPHIC

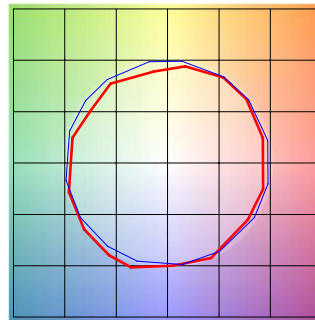

■ Test ■ Reference

HUE BIN	Rf	GRAPHIC SHIFTS %	
		CHROMA	HUE
1	86.6	-4.2%	3.4%
2	91.7	-1.4%	1.8%
3	94.9	-0.7%	0.4%
4	87.9	-4.5%	-4.1%
5	85.9	-10.3%	-2.7%
6	89.8	-5.2%	-0.4%
7	79.6	-9.5%	6.5%
8	87.6	-4.0%	5.7%
9	81.4	-0.5%	11.8%
10	78.3	3.3%	11.4%
11	85.7	6.3%	6.1%
12	86.3	7.1%	-4.6%
13	86.1	-0.7%	-9.6%
14	85.1	0.8%	-10.4%
15	83.4	-4.1%	-5.3%
16	82.5	-3.6%	-5.7%

4000K | Rf: 87.6 | Rg: 96.8

COLOR VECTOR GRAPHIC

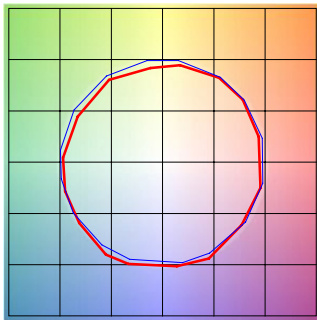

■ Test ■ Reference

HUE BIN	Rf	GRAPHIC SHIFTS %	
		CHROMA	HUE
1	89.0	-3.1%	2.1%
2	93.2	-0.9%	1.3%
3	94.3	-1.1%	0.7%
4	89.5	-4.0%	-2.3%
5	87.6	-7.8%	-1.8%
6	92.2	-4.6%	0.1%
7	87.4	-6.6%	3.6%
8	85.7	-3.8%	7.0%
9	81.5	-1.3%	12.4%
10	80.0	0.9%	11.4%
11	83.3	5.9%	8.7%
12	89.7	4.8%	-0.3%
13	88.5	2.4%	-6.3%
14	92.7	4.0%	-3.8%
15	86.1	-1.6%	-4.5%
16	85.0	-1.4%	-5.0%

5700K | Rf: 80.3 | Rg: 91.5

COLOR VECTOR GRAPHIC

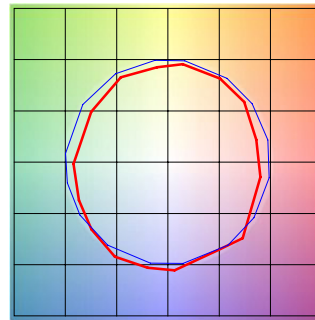

■ Test ■ Reference

HUE BIN	Rf	GRAPHIC SHIFTS %	
		CHROMA	HUE
1	73.8	-11.2%	2.6%
2	83.7	-5.5%	5.8%
3	84.2	-4.0%	5.5%
4	85.8	-3.5%	1.3%
5	85.3	-7.1%	0.6%
6	89.2	-5.8%	-2.2%
7	81.5	-10.7%	1.2%
8	75.7	-9.7%	8.5%
9	74.9	-7.8%	18.8%
10	67.8	-1.6%	18.0%
11	76.1	5.5%	12.0%
12	90.8	4.9%	-1.6%
13	83.6	5.0%	-9.5%
14	81.7	-1.2%	-10.0%
15	69.0	2.0%	-22.8%
16	83.2	-8.5%	-1.0%

PROJECT	FIXTURE TYPE	DATE
---------	--------------	------

NOVA LARGE DOWN MIYO (MAKE IT YOUR OWN) SQUARE WARM DIM LED SUSPENSION WITH POWER

REV.05.01.18

TM-30-15 DATA: The data below is for SS2C, SS5C, SS7C, and SS10C bare LED Soft Strips. Consistent color temperatures throughout a single strip and among multiple strips is possible through a 3 phase binning process in which each order is inspected with a color meter to ensure uniformity.

2700D | Rf: 89.5 | Rg: 100.8

COLOR VECTOR GRAPHIC

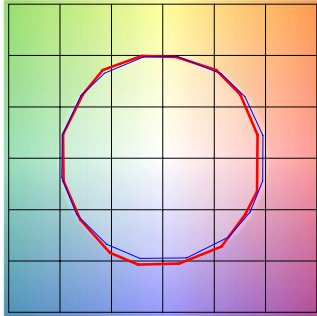

■ Test ■ Reference

		GRAPHIC SHIFTS %	
HUE BIN	Rf	CHROMA	HUE
1	88.8	-5.1%	1.4%
2	89.8	-2.7%	4.1%
3	87.2	0.3%	5.9%
4	92.3	-0.9%	1.0%
5	93.3	1.5%	1.7%
6	92.4	3.6%	-0.2%
7	92.2	-0.9%	-2.4%
8	96.7	-0.4%	-1.1%
9	92.3	-1.2%	3.7%
10	88.9	-0.0%	6.1%
11	86.4	5.1%	7.4%
12	88.2	6.3%	-0.9%
13	87.2	3.8%	-8.1%
14	84.2	3.8%	-11.0%
15	89.8	-2.6%	-4.3%
16	82.7	-3.4%	-11.1%

3000D | Rf: 89.8 | Rg: 101.4

COLOR VECTOR GRAPHIC

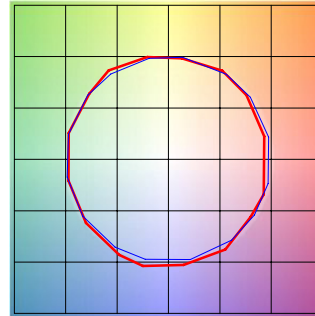

■ Test ■ Reference

		GRAPHIC SHIFTS %	
HUE BIN	Rf	CHROMA	HUE
1	90.2	-4.2%	1.5%
2	90.9	-2.0%	3.7%
3	87.9	0.8%	5.5%
4	92.1	-0.9%	0.6%
5	93.0	1.5%	1.6%
6	92.2	3.9%	-0.2%
7	92.1	-0.3%	-2.0%
8	96.7	0.0%	-1.2%
9	92.5	-0.6%	3.7%
10	88.3	1.1%	7.0%
11	87.2	4.1%	7.4%
12	87.2	6.7%	-1.0%
13	88.2	3.8%	-7.2%
14	85.3	4.3%	-9.9%
15	90.9	-2.2%	-3.6%
16	83.4	-2.2%	-11.2%

2000K only (2K4K) | Rf: 91.6 | Rg: 100.1

COLOR VECTOR GRAPHIC

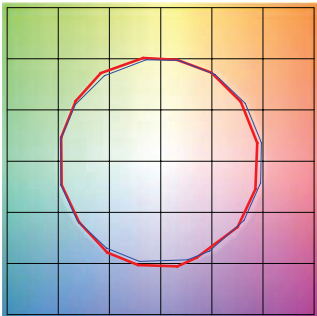

■ Test ■ Reference

		GRAPHIC SHIFTS %	
HUE BIN	Rf	CHROMA	HUE
1	90.2	-4.5%	0.7%
2	90.2	-3.1%	3.8%
3	91.1	-1.0%	4.2%
4	95.0	-0.3%	1.4%
5	95.1	1.5%	2.3%
6	93.5	3.2%	1.5%
7	94.6	0.8%	-3.1%
8	96.5	-0.7%	-0.4%
9	95.9	-1.0%	1.1%
10	93.8	-0.7%	3.1%
11	92.0	3.2%	3.4%
12	91.6	3.9%	-0.4%
13	88.1	4.2%	-11.0%
14	71.4	-1.9%	-14.4%
15	86.4	-2.0%	-8.8%
16	86.2	-4.3%	-7.3%

4000K only (2K4K) | Rf: 87.2 | Rg: 94.9

COLOR VECTOR GRAPHIC

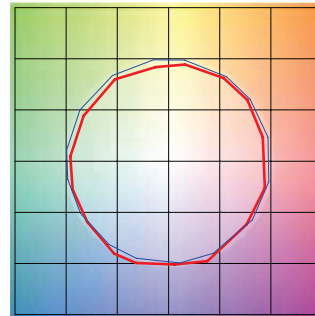

■ Test ■ Reference

		GRAPHIC SHIFTS %	
HUE BIN	Rf	CHROMA	HUE
1	86.6	-5.6%	1.1%
2	91.5	-2.9%	1.5%
3	91.8	-2.8%	1.9%
4	90.1	-4.3%	-1.1%
5	88.6	-7.4%	-0.6%
6	92.2	-4.7%	0.2%
7	88.0	-6.7%	2.9%
8	86.9	-4.9%	5.4%
9	83.3	-3.0%	10.8%
10	80.6	-1.1%	11.0%
11	83.5	4.5%	9.3%
12	89.7	4.4%	0.4%
13	91.0	0.5%	-5.6%
14	85.7	3.1%	-9.4%
15	84.4	-2.4%	-7.1%
16	83.2	-3.1%	-6.8%

2K4K (3000K) | Rf: 91.9 | Rg: 99.6

COLOR VECTOR GRAPHIC

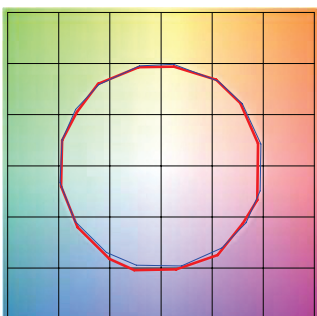

■ Test ■ Reference

		GRAPHIC SHIFTS %	
HUE BIN	Rf	CHROMA	HUE
1	92.1	-3.2%	1.1%
2	94.0	-1.7%	1.8%
3	93.0	-0.3%	2.9%
4	93.4	-2.5%	-0.7%
5	94.8	-1.4%	1.0%
6	96.3	0.6%	0.1%
7	92.3	-3.0%	1.2%
8	97.3	-0.6%	0.9%
9	92.3	-0.6%	4.3%
10	88.9	1.0%	6.5%
11	89.2	3.6%	6.5%
12	89.8	5.2%	-0.8%
13	90.9	2.1%	-5.9%
14	88.3	3.3%	-7.8%
15	92.0	-2.4%	-2.0%
16	86.1	-1.4%	-9.5%

PROJECT		FIXTURE TYPE		DATE	
---------	--	--------------	--	------	--