

Description: Surface Mount Light Channels feature 24 volt Soft Strip, inside a slim, paintable aluminum extrusion. LCSM uses premium grade with warm-white, 80+CRI LEDs for excellent color-rendering. LCSMC uses commercial grade 85+ or 95+CRI LEDs. Several color temperature options are available, including 24K – 57K (ELV/010) and Warm Dim (ELV). The 61 degree white diffuser lens projects a clean line of light and eliminates LED dots, while the clear lens provides maximum light levels. Available in various sizes up to 120 inches. See chart on page 4 for ordering codes and exact dimensions. Fixtures include mounting clips every 2 feet and can be linked end-to-end with plug-in or flexible connectors to a maximum of 20 feet for 2D and 3D color temperatures, 40 feet for all other color temperatures. System is powered by a dimmable, remote power supply. Fixtures include a 5 year warranty.

Applications: Indoor and Wet Location - Task lighting, under/above cabinet, cove and retail. ETL listed for wet location.

DWW: Warm White with 61° White Diffuser Lens		
Distance	Beam	Foot Candles
12in	15"	58 FC
18in	21"	34 FC
24in	29"	24 FC
36in	42"	13 FC

CWW: Warm White with 26° Clear Diffuser Lens		
Distance	Beam	Foot Candles
12in	7"	115 FC
18in	10"	72 FC
24in	13"	50 FC
36in	16"	28 FC

Lamp:

Version	Watts per Foot	Lumens per Watt	Lumens per Foot	80+CRI 30K	85+CRI 24K, 35K, 40K, 57K	92+CRI 27D, 30D	95+CRI 27K, 30K	Lamp Life Hours
LCSM	2.3	37	115	●				50,000
LCSMC	2.5	43	126		●		●	50,000
LCSMC (Warm Dim)	5	50	244			●		50,000

Lumen values are based on the 3000K LED test.

24VDC 0-10V Power Supply (Sold Separately, Not used with Warm Dim):

- PSB-96W-010-24VDC** 120-277VAC input, 96 watt output
- PSB-2X96W-010-24VDC** 120-277VAC input, 2x96 watt output
- PSB-3x96W-010-24VDC** 120-277VAC input, 3x96 watt output
- PSB-4x96W-010-24VDC** 120-277VAC input, 4x96 watt output

24VDC ELV Power Supply (Sold Separately):

- PSB-60W-ELV-24VDC** 120VAC input, 60 watt output
- PSB-100W-ELV-24VDC** 120VAC input, 96 watt output
- PSB-2X100W-ELV-24VDC** 120VAC input, 2x96 watt output
- PSB-3x100W-ELV-24VDC** 120VAC input, 3x96 watt output
- PSB-4x100W-ELV-24VDC** 120VAC input, 4x96 watt output

Dimming: 010 power supplies use 0-10V dimmer: Philips Sunrise SR1200ZTUNV.

ELV power supplies use ELV dimmer: Legrand, Adorne ADTP703TU;

Lutron: Diva DVELV-300P, Skylark SELV-300P, Maestro MAELV-600 and Radio Ra 2

Product	Voltage	Nominal Size	Color Temperature	Finish	Options
LCSM	24V	60IN	D VW	SA	Standard (Leave blank)
LCSM Light Channel Surface Mount LCSMC Light Channel Surface Mount Commercial	24V 24 Volt DC	12-120 Order in 12 inch increments up to 120 inches May be ordered in 3, 5, 8 or 10 inch increments	D Diffuser Lens C Clear Lens AW 2400K Amber White (LCSMC only) VW 2700K Very Warm White (LCSMC only) WW 3000K Warm White NW 3500K Neutral White (LCSMC only) CW 4000K Cool White (LCSMC only) DW 5700K Daylight White (LCSMC only) 2D 2700K Warm Dim (LCSMC only, 5W/ft) 3D 3000K Warm Dim (LCSMC only, 5W/ft)	SA Satin Aluminum Custom Finishes Available	W Wet Location

PROJECT: _____ FIXTURE TYPE: _____ DATE: _____



Application: Electronic low-voltage dimming for Surface Mount Light Channel

Power Supply: 120VAC input, 24VDC 60 watt output PSB-60W-ELV-24VDC

Dimming: Dimmable with low voltage electronic dimmer using power supply above. See power supply spec sheet for additional details. Lutron: Diva DVELV-300P; Skylark SELV-300P; Maestro MAELV-600 dimmers are recommended.

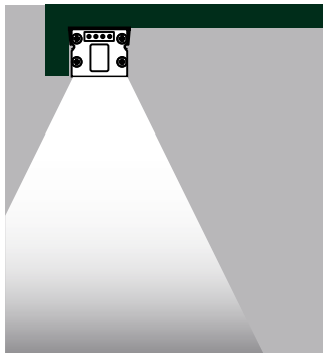
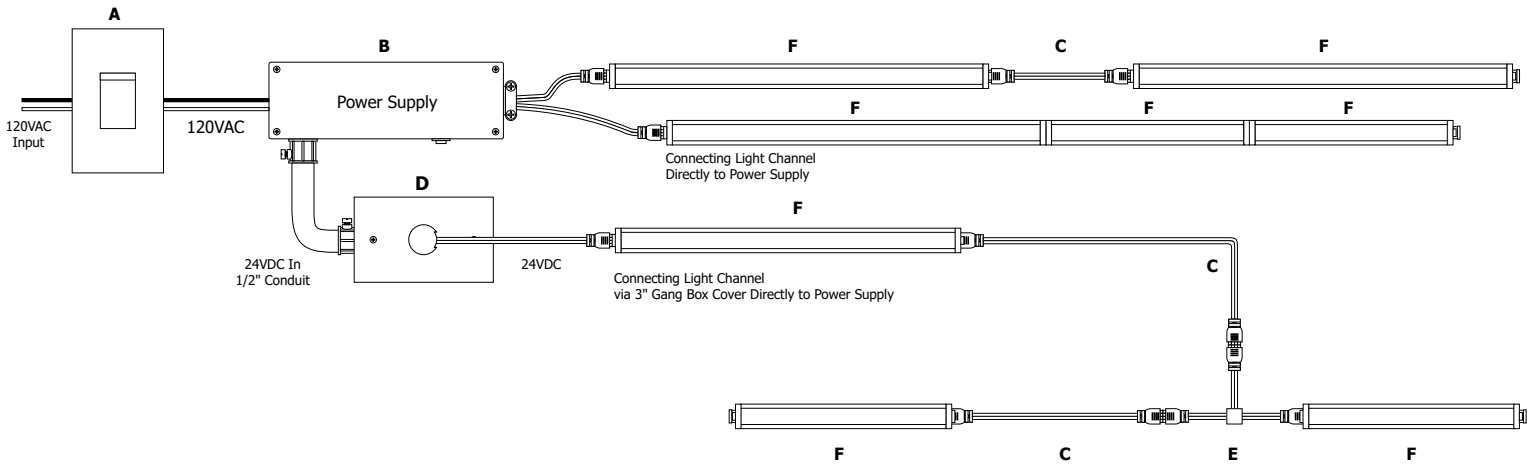

Shown with LC-MCL

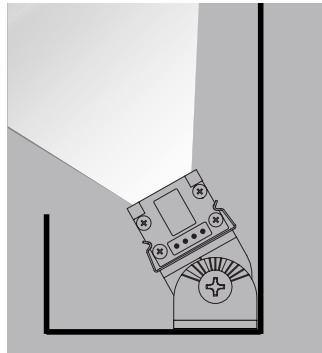

Shown with LC-MCL-075

- A. Lutron Dimmers
Diva **DVELV-300P** or Skylark **SELV-300P**
- B. 60W 24VDC Power Supply
PSB-60W-ELV-24VDC
- C. Flexible connector order to length 3"-144" **LC-CFX-__**
- D. 3" Rectangle Canopy Cover **3RE-WH**
- E. Flexible T shape connector
SS-CFXT-3IN
- F. Surface Mount Light Channel 12"-120" **LCSM-24V-__-__-SA**

PROJECT:

FIXTURE
TYPE:

DATE:



Application: 0-10V dimming for Surface Mount Light Channel (Not to be used with Warm Dim)

Power Supply: Class 2, 24VDC output: 120-277VAC input, 96 watt output PSB-96W-010-24VDC;
120-277VAC input, 192 watt output PSB-2X96W-010-24VDC

Dimming: Dimmable with 0-10V dimmer using power supply above. See power supply spec sheet for additional details. Philips Sunrise SR1200ZTUNV 0-10V dimmer recommended.

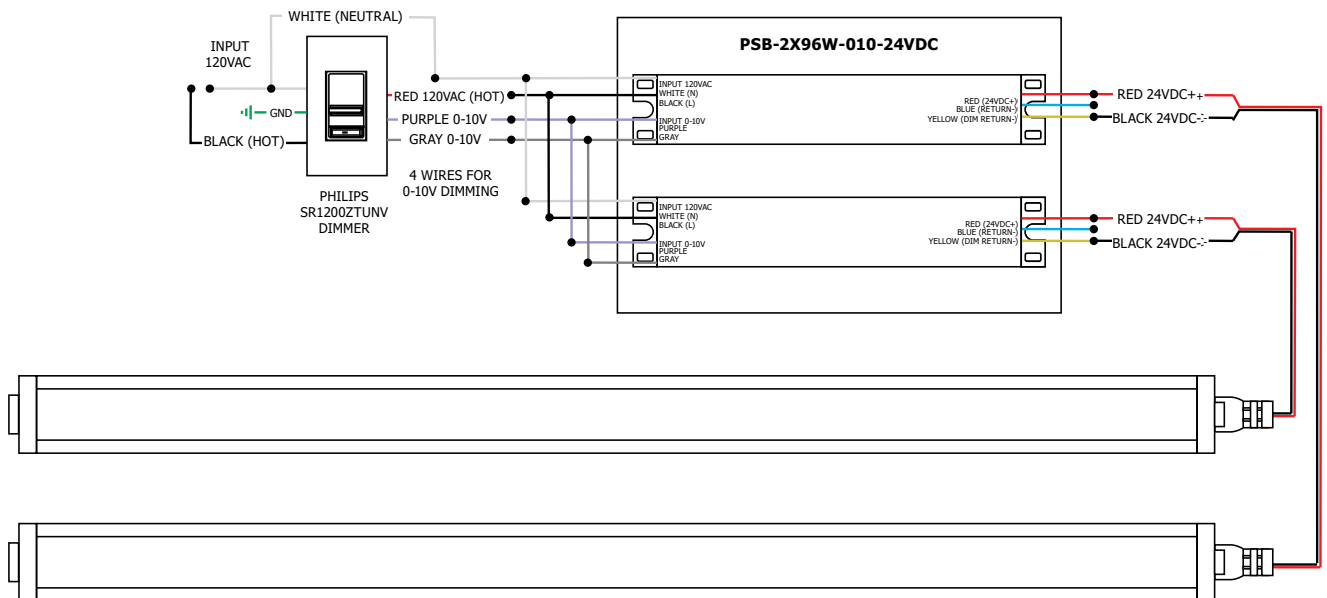
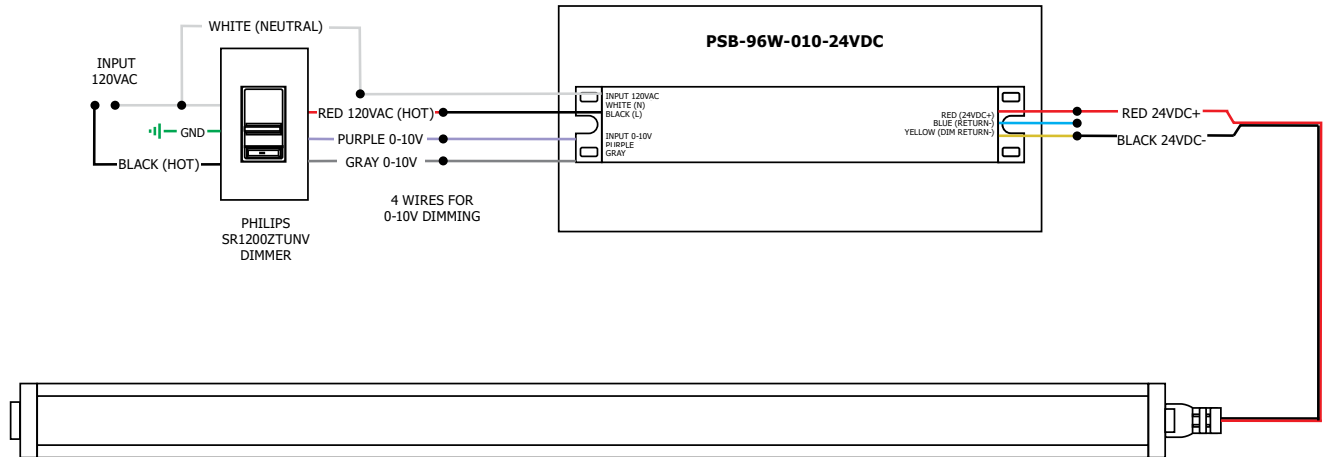

SURFACE MOUNT LIGHT CHANNEL ACTUAL SIZE

AW, VW, WW, NW, CW, DW

2D, 3D

ORDERING CODE (NOMINAL SIZE)	LENGTH (INCHES)
3IN	3.34
5IN	5.74
8IN	8.14
10IN	10.54
12IN	12.94
15IN	15.34
17IN	17.74
20IN	20.14
22IN	22.54
24IN	24.94
27IN	27.34
29IN	29.74
32IN	32.14
34IN	34.54
36IN	36.94
39IN	39.34
41IN	41.74
44IN	44.14
46IN	46.54
48IN	48.94
51IN	51.34
53IN	53.74
56IN	56.14
58IN	58.54
60IN	60.94

ORDERING CODE (NOMINAL SIZE)	LENGTH (INCHES)
63IN	63.34
65IN	65.74
68IN	68.14
70IN	70.54
72IN	72.94
75IN	75.34
77IN	77.74
80IN	80.14
82IN	82.54
84IN	84.94
87IN	87.34
89IN	89.74
92IN	92.14
94IN	94.54
96IN	96.94
99IN	99.34
101IN	101.74
104IN	104.14
106IN	106.54
108IN	108.94
111IN	111.34
113IN	113.74
116IN	116.14
118IN	118.54
120IN	120.94

ORDERING CODE (NOMINAL SIZE)	LENGTH (INCHES)
3IN	3.94
6IN	6.94
9IN	9.94
12IN	12.94
15IN	15.94
18IN	18.94
21IN	21.94
24IN	24.94
27IN	27.94
30IN	30.94
33IN	33.94
36IN	36.94
39IN	39.94
42IN	42.94
45IN	45.94
48IN	48.94
51IN	51.94
54IN	54.94
57IN	57.94
60IN	60.94
63IN	63.94
66IN	66.94
69IN	69.94
72IN	72.94
75IN	75.94

ORDERING CODE (NOMINAL SIZE)	LENGTH (INCHES)
78IN	78.94
81IN	81.94
84IN	84.94
87IN	87.94
90IN	90.94
93IN	93.94
96IN	96.94
99IN	99.94
102IN	102.94
105IN	105.94
108IN	108.94
111IN	111.94
114IN	114.94
117IN	117.94
120IN	120.94

PROJECT:

FIXTURE TYPE:

DATE:



SURFACE MOUNT LIGHT CHANNEL

REV:03.29.17

ASSEMBLED IN AMERICA

TM-30-15 DATA: The data below is for SS2C and SS5C bare LED Soft Strips. Consistent color temperatures throughout a single strip and among multiple strips is possible through a 3 phase binning process in which each order is inspected with a color meter to ensure uniformity.

2400K | Rf: 83.9 | Rg: 94.9

COLOR VECTOR GRAPHIC

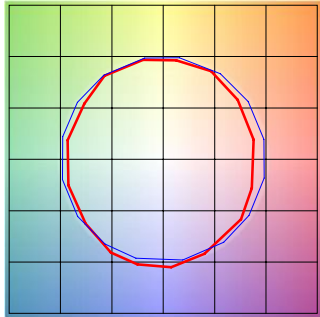

■ Test ■ Reference

HUE BIN	Rf	GRAPHIC SHIFTS %	
		CHROMA	HUE
1	77.6	-10.0%	1.8%
2	80.7	-7.5%	7.0%
3	79.5	-2.9%	8.9%
4	90.5	-3.1%	2.4%
5	93.9	-1.3%	1.9%
6	91.9	-0.9%	-0.2%
7	87.6	-6.3%	-2.7%
8	90.5	-5.4%	2.7%
9	83.8	-4.7%	6.5%
10	81.2	-2.5%	10.0%
11	83.3	3.9%	9.4%
12	86.4	5.6%	2.6%
13	86.2	4.5%	-12.4%
14	64.3	-1.0%	-21.9%
15	85.1	-4.4%	-7.5%
16	75.0	-9.9%	-12.0%

2700K | Rf: 87.7 | Rg: 96.1

COLOR VECTOR GRAPHIC

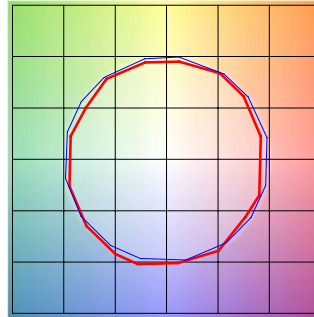

■ Test ■ Reference

HUE BIN	Rf	GRAPHIC SHIFTS %	
		CHROMA	HUE
1	86.4	-5.6%	2.3%
2	89.7	-3.3%	3.1%
3	90.5	-1.5%	3.8%
4	90.0	-4.3%	1.1%
5	92.9	-3.7%	0.2%
6	93.5	-2.5%	-0.8%
7	86.3	-7.2%	2.5%
8	90.7	-4.0%	3.2%
9	85.2	-2.4%	8.1%
10	81.7	0.9%	10.8%
11	85.4	4.5%	8.9%
12	88.7	5.7%	-1.4%
13	88.3	1.3%	-7.9%
14	85.1	2.4%	-10.4%
15	88.1	-4.8%	-2.7%
16	81.7	-4.3%	-10.9%

3000K | Rf: 88.1 | Rg: 99.7

COLOR VECTOR GRAPHIC

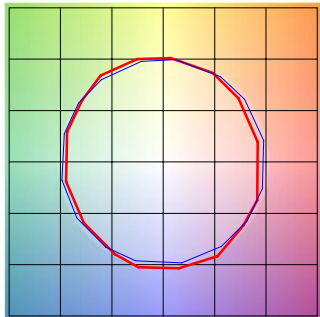

■ Test ■ Reference

HUE BIN	Rf	GRAPHIC SHIFTS %	
		CHROMA	HUE
1	87.7	-5.9%	-0.3%
2	87.9	-4.4%	4.3%
3	82.9	-1.2%	7.9%
4	89.9	0.6%	4.7%
5	92.7	3.0%	3.5%
6	92.7	3.6%	-1.7%
7	90.8	-1.3%	-4.4%
8	93.7	-2.5%	-2.2%
9	91.7	-3.7%	2.3%
10	85.5	-2.8%	7.8%
11	83.3	0.7%	11.0%
12	86.4	5.5%	3.8%
13	90.6	4.6%	-3.6%
14	85.6	5.9%	-8.4%
15	89.5	-0.6%	-5.7%
16	82.6	-2.7%	-12.0%

3500K | Rf: 86.1 | Rg: 95.5

COLOR VECTOR GRAPHIC

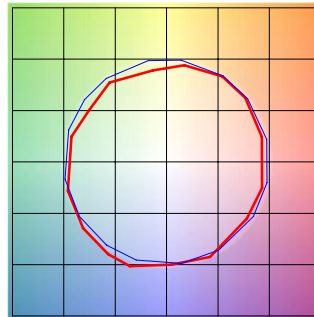

■ Test ■ Reference

HUE BIN	Rf	GRAPHIC SHIFTS %	
		CHROMA	HUE
1	86.6	-4.2%	3.4%
2	91.7	-1.4%	1.8%
3	94.9	-0.7%	0.4%
4	87.9	-4.5%	-4.1%
5	85.9	-10.3%	-2.7%
6	89.8	-5.2%	-0.4%
7	79.6	-9.5%	6.5%
8	87.6	-4.0%	5.7%
9	81.4	-0.5%	11.8%
10	78.3	3.3%	11.4%
11	85.7	6.3%	6.1%
12	86.3	7.1%	-4.6%
13	86.1	-0.7%	-9.6%
14	85.1	0.8%	-10.4%
15	83.4	-4.1%	-5.3%
16	82.5	-3.6%	-5.7%

4000K | Rf: 87.6 | Rg: 96.8

COLOR VECTOR GRAPHIC

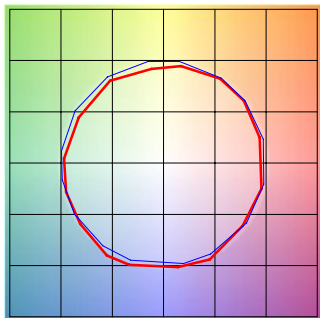

■ Test ■ Reference

HUE BIN	Rf	GRAPHIC SHIFTS %	
		CHROMA	HUE
1	89.0	-3.1%	2.1%
2	93.2	-0.9%	1.3%
3	94.3	-1.1%	0.7%
4	89.5	-4.0%	-2.3%
5	87.6	-7.8%	-1.8%
6	92.2	-4.6%	0.1%
7	87.4	-6.6%	3.6%
8	85.7	-3.8%	7.0%
9	81.5	-1.3%	12.4%
10	80.0	0.9%	11.4%
11	83.3	5.9%	8.7%
12	89.7	4.8%	-0.3%
13	88.5	2.4%	-6.3%
14	92.7	4.0%	-3.8%
15	86.1	-1.6%	-4.5%
16	85.0	-1.4%	-5.0%

5700K | Rf: 80.3 | Rg: 91.5

COLOR VECTOR GRAPHIC

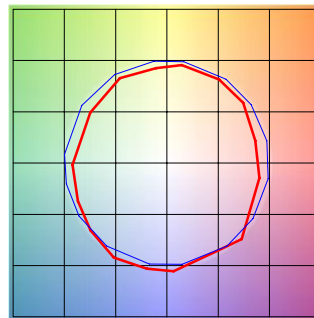

■ Test ■ Reference

HUE BIN	Rf	GRAPHIC SHIFTS %	
		CHROMA	HUE
1	73.8	-11.2%	2.6%
2	83.7	-5.5%	5.8%
3	84.2	-4.0%	5.5%
4	85.8	-3.5%	1.3%
5	85.3	-7.1%	0.6%
6	89.2	-5.8%	-2.2%
7	81.5	-10.7%	1.2%
8	75.7	-9.7%	8.5%
9	74.9	-7.8%	18.8%
10	67.8	-1.6%	18.0%
11	76.1	5.5%	12.0%
12	90.8	4.9%	-1.6%
13	83.6	5.0%	-9.5%
14	81.7	-1.2%	-10.0%
15	69.0	2.0%	-22.8%
16	83.2	-8.5%	-1.0%

PROJECT:

FIXTURE
TYPE:

DATE:



SURFACE MOUNT LIGHT CHANNEL

REV.03.29.17

ASSEMBLED IN AMERICA

TM-30-15 DATA: The data below is for SS2C and SS5C bare LED Soft Strips. Consistent color temperatures throughout a single strip and among multiple strips is possible through a 3 phase binning process in which each order is inspected with a color meter to ensure uniformity.

2700D | Rf: 89.5 | Rg: 100.8

COLOR VECTOR GRAPHIC

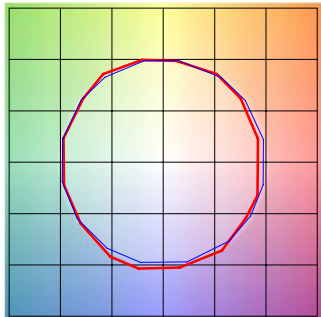

■ Test ■ Reference

HUE BIN	Rf	GRAPHIC SHIFTS %	
		CHROMA	HUE
1	88.8	-5.1%	1.4%
2	89.8	-2.7%	4.1%
3	87.2	0.3%	5.9%
4	92.3	-0.9%	1.0%
5	93.3	1.5%	1.7%
6	92.4	3.6%	-0.2%
7	92.2	-0.9%	-2.4%
8	96.7	-0.4%	-1.1%
9	92.3	-1.2%	3.7%
10	88.9	-0.0%	6.1%
11	86.4	5.1%	7.4%
12	88.2	6.3%	-0.9%
13	87.2	3.8%	-8.1%
14	84.2	3.8%	-11.0%
15	89.8	-2.6%	-4.3%
16	82.7	-3.4%	-11.1%

3000D | Rf: 89.8 | Rg: 101.4

COLOR VECTOR GRAPHIC

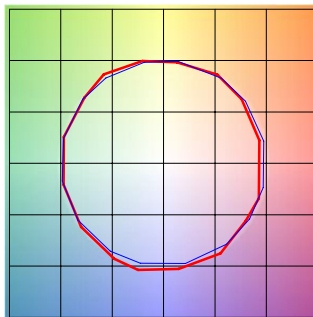

■ Test ■ Reference

HUE BIN	Rf	GRAPHIC SHIFTS %	
		CHROMA	HUE
1	90.2	-4.2%	1.5%
2	90.9	-2.0%	3.7%
3	87.9	0.8%	5.5%
4	92.1	-0.9%	0.6%
5	93.0	1.5%	1.6%
6	92.2	3.9%	-0.2%
7	92.1	-0.3%	-2.0%
8	96.7	0.0%	-1.2%
9	92.5	-0.6%	3.7%
10	88.3	1.1%	7.0%
11	87.2	4.1%	7.4%
12	87.2	6.7%	-1.0%
13	88.2	3.8%	-7.2%
14	85.3	4.3%	-9.9%
15	90.9	-2.2%	-3.6%
16	83.4	-2.2%	-11.2%

2000K only (2K4K) | Rf: 84.3 | Rg: 96.9

COLOR VECTOR GRAPHIC

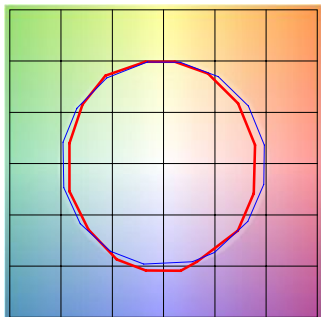

■ Test ■ Reference

HUE BIN	Rf	GRAPHIC SHIFTS %	
		CHROMA	HUE
1	80.3	-8.9%	1.7%
2	79.7	-7.0%	7.8%
3	78.9	-2.9%	10.0%
4	89.5	-0.5%	5.1%
5	94.4	0.7%	1.7%
6	92.1	2.4%	-0.3%
7	89.4	-2.4%	-5.9%
8	89.7	-6.4%	-0.2%
9	86.0	-4.9%	4.6%
10	81.8	-3.4%	9.3%
11	83.1	3.3%	9.7%
12	85.8	5.6%	3.3%
13	85.6	6.2%	-12.8%
14	61.7	-1.9%	-19.0%
15	79.7	-3.3%	-12.9%
16	78.1	-7.9%	-10.6%

4000K only (2K4K) | Rf: 89.6 | Rg: 99.1

COLOR VECTOR GRAPHIC

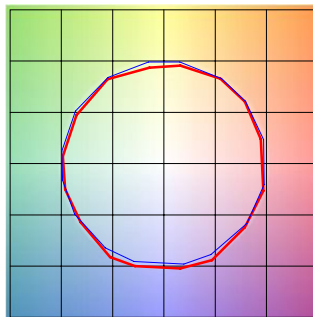

■ Test ■ Reference

HUE BIN	Rf	GRAPHIC SHIFTS %	
		CHROMA	HUE
1	91.3	-2.5%	1.0%
2	95.3	-0.5%	0.5%
3	94.3	-0.7%	1.1%
4	91.1	-3.4%	-1.1%
5	89.5	-5.6%	0.0%
6	94.6	-1.4%	1.3%
7	93.2	-3.0%	2.6%
8	91.3	-1.8%	4.6%
9	86.5	-0.9%	9.1%
10	83.3	-0.5%	9.5%
11	83.3	4.9%	9.0%
12	89.7	4.1%	1.7%
13	90.1	3.6%	-4.3%
14	93.4	5.2%	-2.1%
15	87.4	0.4%	-4.3%
16	86.6	0.4%	-6.1%

2K4K (3000K) | Rf: 90.2 | Rg: 101.4

COLOR VECTOR GRAPHIC

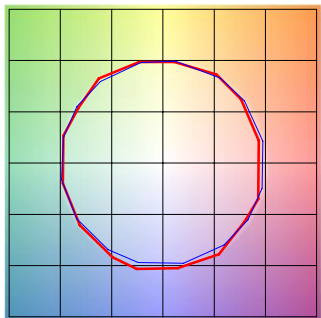

■ Test ■ Reference

HUE BIN	Rf	GRAPHIC SHIFTS %	
		CHROMA	HUE
1	90.9	-3.8%	1.3%
2	91.7	-1.9%	3.3%
3	88.7	0.7%	5.1%
4	92.4	-1.0%	0.7%
5	92.9	0.9%	1.7%
6	93.1	3.3%	-0.6%
7	91.0	-1.8%	-0.4%
8	97.0	0.2%	-1.1%
9	92.8	-0.5%	3.6%
10	88.3	1.0%	7.0%
11	87.1	3.8%	7.8%
12	87.6	6.5%	-0.3%
13	89.3	3.6%	-6.3%
14	86.1	4.5%	-9.1%
15	91.6	-1.9%	-3.1%
16	83.8	-1.5%	-11.2%

PROJECT:

FIXTURE
TYPE:

DATE:

