

# ZIP LED BIY (BUILD IT YOURSELF)

## CEILING/WALL, 24VDC REMOTE POWER

DESIGNED BY GREGORY KAY | ASSEMBLED IN AMERICA

REV 08.02.21



### DESCRIPTION

ZIP LED BIY (Build-It-Yourself) Ceiling/Wall LED System allows the Designer to create more complex configurations using Pre-Formed Components and connectors which simplify the installation process. Multiple runs of channel mount flawlessly together providing smooth, glare-free architectural illumination. The system mounts to a wall or ceiling with mounting clips and small junction box provided. The ZIP Wall/Ceiling Channel and Lens are sold in 4', 5', 8', and 10' increments. LED Soft Strip is sold in 1' increments up to 40' for 2.5 watt strip. Offered in multiple standard color temperatures: 2200K-5700K, Warm Dim (**27D or 30D**) and, Tunable White (**2K6K or 27K6**). Includes a 5 year pro-rated warranty. For custom designs and quotes, send drawings to [design@PureEdgeLighting.com](mailto:design@PureEdgeLighting.com).

### APPLICATIONS

Indoor damp or dry locations only. General illumination and architectural accent at top of ceiling for room wrapping or wall to ceiling. Ideal applications in Commercial, Retail, Residential, Hospitality, Education and Healthcare Institutions.

### LAMP

- Refer to pages 7 and 8 for photometric Data
- The average LED Life is 50,000 hours

### REMOTE POWER SUPPLIES\* & DIMMERS (SOLD SEPARATELY)

- Uni Driver: Universal Dimming (**0-10V, ELV, TRIAC**)
- Electronic Low Voltage Dimming (**ELV**)<sup>†</sup>
- 0-10 Volt Dimming (**0-10V**)
- Lutron Hi-Lume<sup>®</sup>
- DMX: Dynamic Color

<sup>†</sup>In-Wall Mounting Kits available for select power supplies

<sup>‡</sup>With N-Lite Dimming Do Not use ELV power supplies, use only 0-10 volt or Uni drivers power supplies.

<sup>\*\*</sup>Tunable White - Requires two dimmers (one for each Kelvin) or use our proprietary Tunable White Controller CDMX-1

### ROOM WRAPPING DESIGN NOTE

Zip Ceiling/Wall can be installed on a horizontal single surface around the perimeter of a room, or on a vertical wall surface then turning across the ceiling. Add BIY Pre-Formed Components to create desired Room Wrapping Installations.

Room Wrapping is the style of installation in which the electrician may miter-cut 45° inside and outside angles in the field. The LED Soft Strip is installed flat on the back of the channel and bends within inside or outside corners for seamless light across surfaces.

### PRE-FORMED COMPONENTS

Channel and Lens, Power and Non-Power End Caps, and Channel Joiner

### COMPLIANCE

Class 2 Wiring up to 100 watts, Damp Location Suitable, ETL listed.

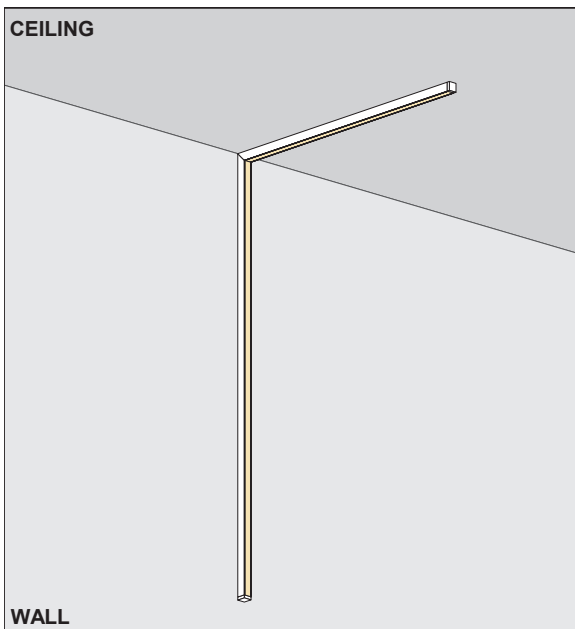

VERTICAL ROOM WRAPPING CONFIGURATION

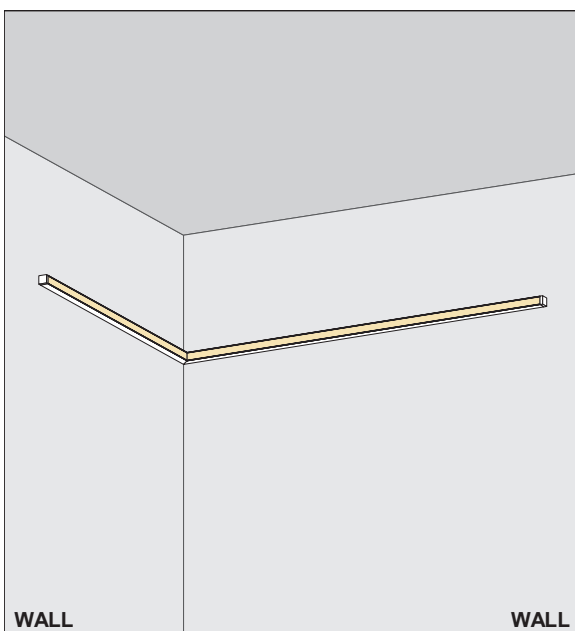

HORIZONTAL ROOM WRAPPING CONFIGURATION

PROJECT		FIXTURE TYPE		DATE	
---------	--	--------------	--	------	--

# ZIP LED BIY (BUILD IT YOURSELF)

## CEILING/WALL, 24VDC REMOTE POWER

REV 08.02.21

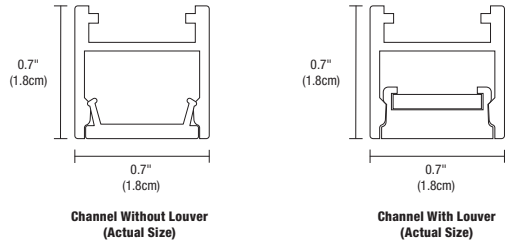

### CHANNEL & LENS

4', 5', 8' & 10' Channel with Lens. LED Soft Strip (not included) will be installed flat in the channel. Field cuttable to any length. Add Channel Joiner below, as needed.

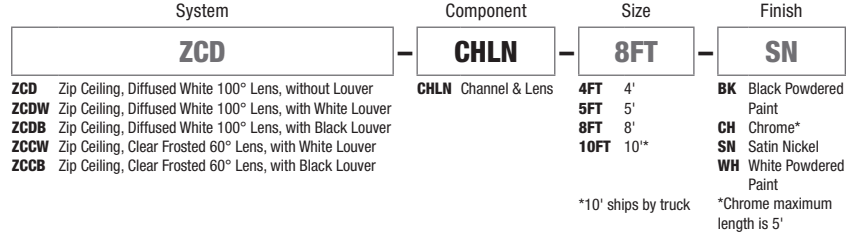

### END CAP POWER WITH CANOPY

Power End Cap Connector joins the Zip Modular Ceiling and electrically provides power from a Remote Power Supply through the Power canopy. Includes Power Canopy and 6' of Power Cable, which easily adjusts at Canopy. 1RE J-box included with ordering code.

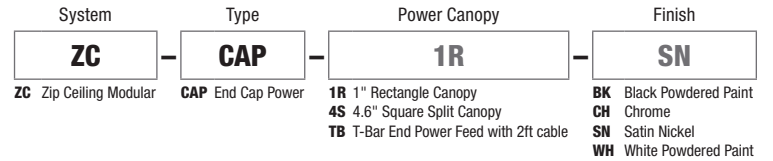
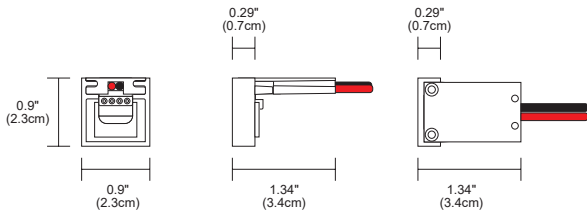

### END CAP POWER WITH CANOPY, TUNABLE WHITE

Power End Cap Connector joins the Zip Modular Ceiling and electrically provides power from a Remote Power Supply through the Power canopy. Includes Power Canopy and 6' of Power Cable, which easily adjusts at Canopy. 1RE J-box included with ordering code.

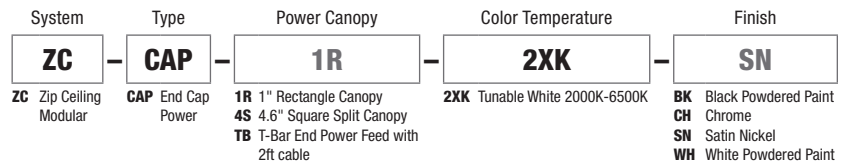
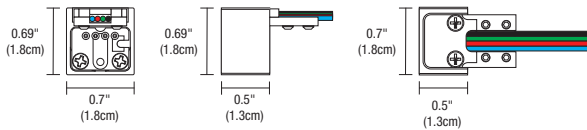

### END CAP

End Cap terminates the Zip Ceiling Downlight Modular Channel run and provides a finished look.

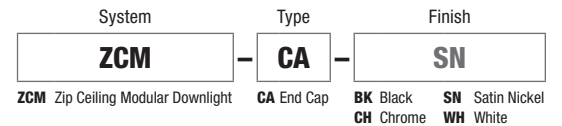
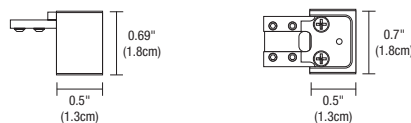

### STRAIGHT CONNECTOR

Straight Connectors join two sections of Zip Channel.

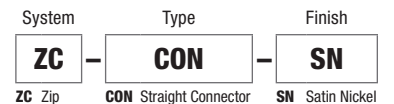
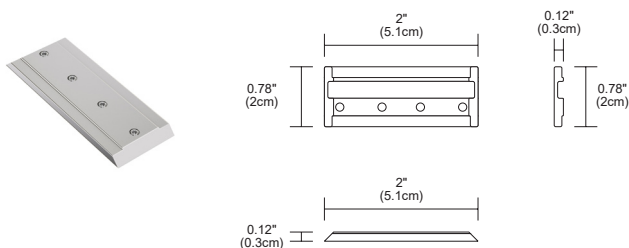

PROJECT	FIXTURE TYPE	DATE
---------	--------------	------

# ZIP LED BIY (BUILD IT YOURSELF)

## CEILING/WALL, 24VDC REMOTE POWER

REV 08.02.21

**COMPONENTS:** Jbox, Split Canopies, and Mounting Clips are included and sold separately for replacement

### 1" RECTANGLE CANOPY WITH JUNCTION BOX

The Slim-Profile Junction Box with hanger bars mounts to studs spaced between 14.5 and 25 inches apart behind drywall. Allows low voltage DC wires from remote power supply to connect to channel wires. The junction box opening is covered by the fixture for a clean, safe connection. Includes a goof plate for poor plastering around j-box.

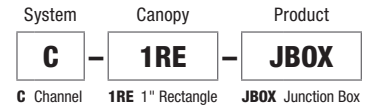
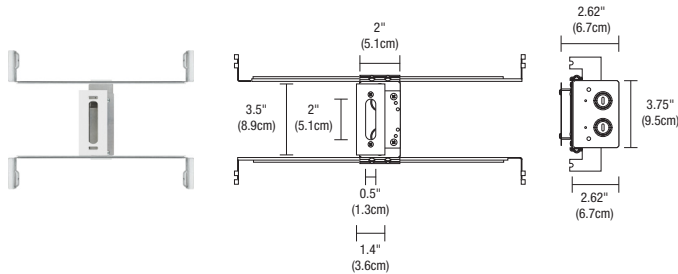

### 1" RECTANGLE CANOPY & J-BOX WITH 50W POWER SUPPLY (ORDER SEPARATELY)

The Slim-Profile Junction Box with Hanger Bars mounts to studs spaced between 14.5" and 25" apart behind drywall. Allows low voltage DC wires from included power supply to connect to channel wires. The Junction Box opening is covered by the fixture for a clean, safe connection. Rated 60 watts for Non-Insulated Ceiling or Wall Power Supply. Rated 50 watts for Insulated Ceiling. Includes a Goof Plate, for poor plastering around J-box.

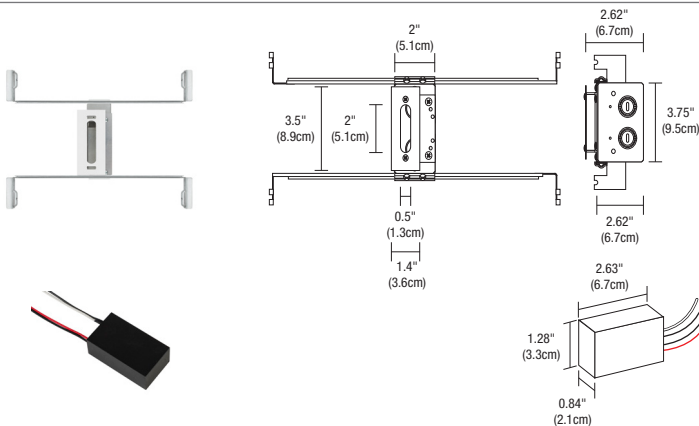

### 4" SQUARE SPLIT CANOPY (INCLUDED WITH 4S SELECTED IN FIXTURE ORDERING CODE)

The 4" Square Canopy fits on a standard 4" electrical box with round plaster ring. It fits flush along channel while covering Junction Box. The Canopy may float anywhere along the channel and comes in six finishes.

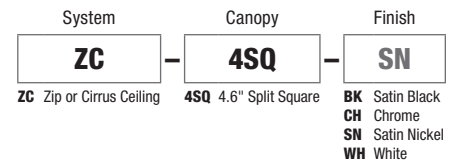
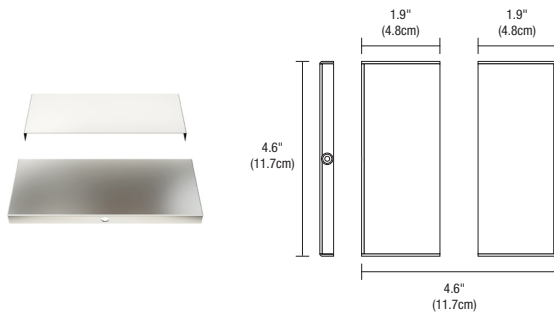

### CEILING MOUNTING CLIP (INCLUDED)

Drywall ceiling mounted spring clips are provided with every 2ft of Zip Ceiling Channel. The Clip snaps into the channel, staying securely fastened to the ceiling or wall. Includes anchors and screws.

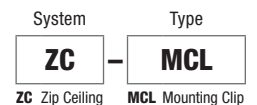
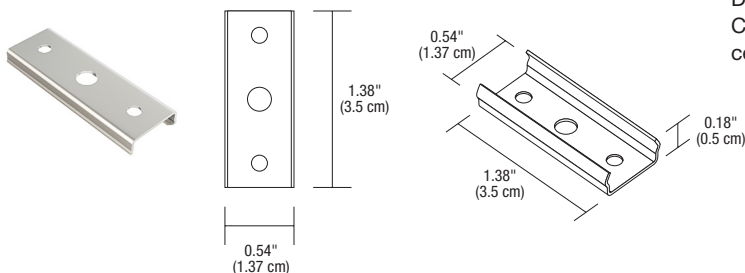

PROJECT	FIXTURE TYPE	DATE
---------	--------------	------

# ZIP LED BIY (BUILD IT YOURSELF)

## CEILING/WALL, 24VDC REMOTE POWER

REV 08.02.21

**COMPONENTS:** Jbox, Split Canopies, and Mounting Clips are included and sold separately for replacement



### CEILING MOUNTING LOCKING CLIP

Drywall ceiling mounting locking clips are provided with every two feet of the Zip Ceiling Downlight and may be ordered separately or as replacement parts. The channel slides into the clip and locks into place staying securely fastened to the ceiling. Use for earthquake zones.

System	Type	Option
<b>ZC</b>	<b>MCL</b>	<b>L</b>
ZC Zip Ceiling	MCL Mounting Clip	L Locking

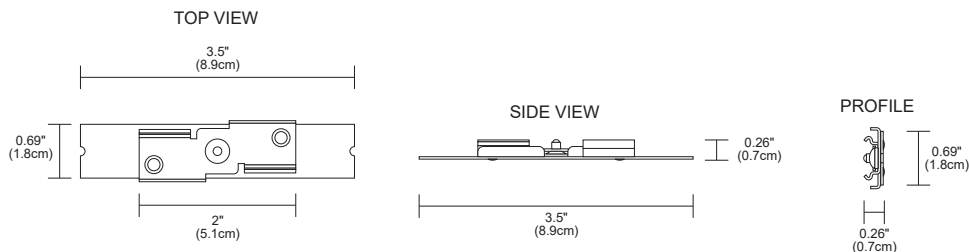

### CEILING MOUNTING T-BAR CLIPS FOR 15/16" CEILING GRID

Mounts flush anywhere along the 15/16" T-Bar Grid. 1 clip is needed for every 2' of Channel. A 3/8" spacer (TBB) is optional where the ceiling panels are below the grid.

System	Canopy	Type	Finish
<b>ZC</b>	<b>MCL</b>	<b>TBA</b>	<b>WH</b>
ZC Zip Ceiling	MCL Mounting Clip	<b>TBA</b> Use with 15/16" Wide T-bar where the ceiling panels are flush with the grid <b>TBB</b> Use with 15/16" Wide T-bar grid where panels are 3/8" below grid	<b>WH</b> White <b>BK</b> Black

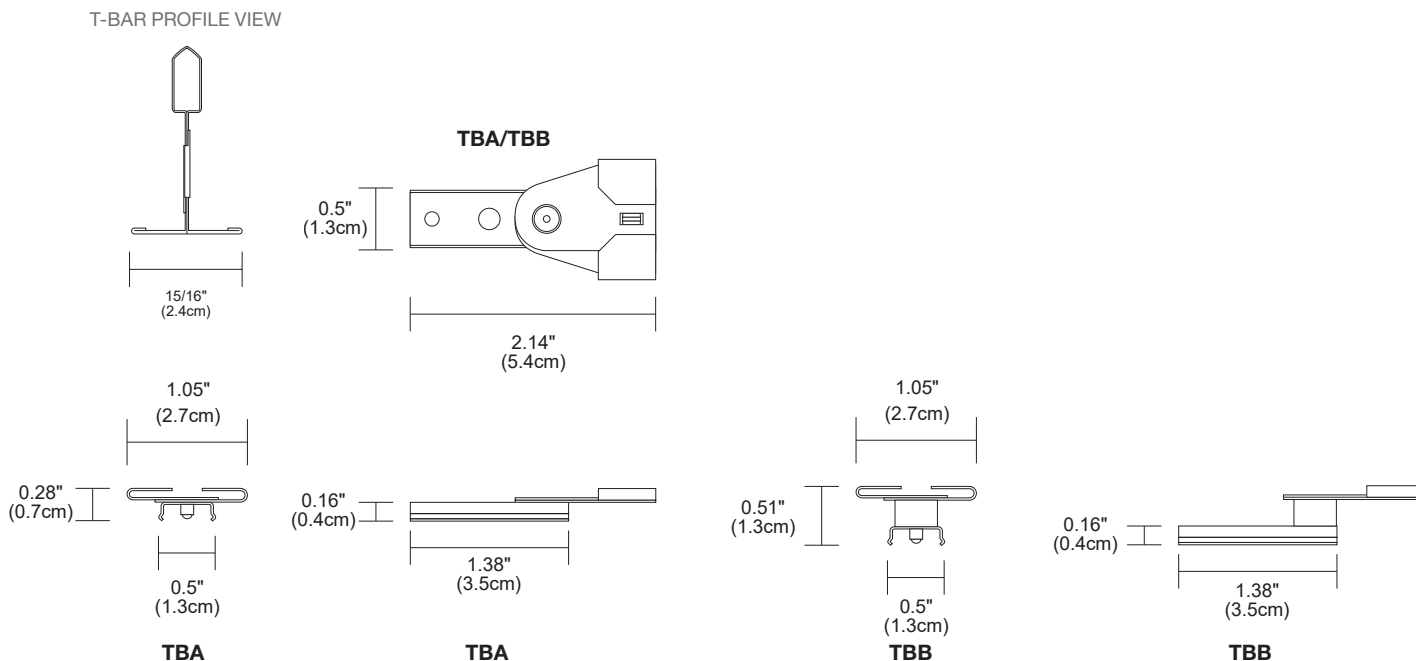

PROJECT	FIXTURE TYPE	DATE
---------	--------------	------

**COMPONENTS:** Jbox, Split Canopies, and Mounting Clips are included and sold separately for replacement

### CEILING MOUNTING T-BAR CLIPS FOR 9/16" CEILING GRID

Mounts flush anywhere along the 9/16" T-Bar Grid. 1 clip is needed for every 2' of Channel . A 3/8" spacer (TBD) is optional where the ceiling panels are below the grid.

T-BAR PROFILE VIEW

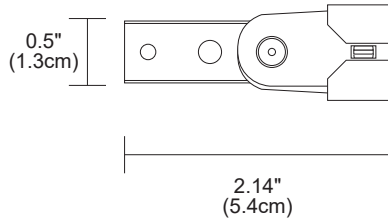

System	Canopy	Type	Finish
<b>ZC</b>	<b>MCL</b>	<b>TBC</b>	<b>WH</b>
ZC Zip Ceiling	MCL Mounting Clip	TBC Use with 9/16" Wide T-bar where the ceiling panels are flush with the grid TBD Use with 9/16" Wide T-bar grid where panels are 3/8" below grid	WH White BK Black

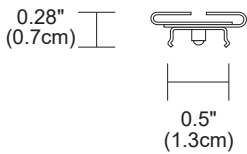

**TBC**

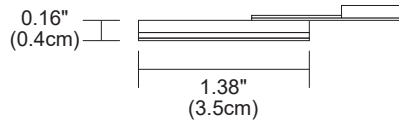

**TBC**

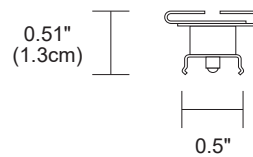

**TBD**

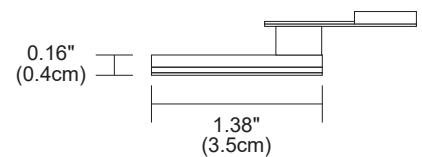

**TBD**

### T-BAR END MOUNTING CLIP 9/16" CEILING GRID

T-bar end mounting clip is a mounting option for T-bar grid ceilings. The channel slides into the clip and locks, staying in place securely fastened to the ceiling.

T-BAR PROFILE VIEW

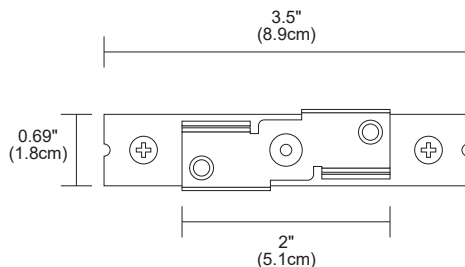
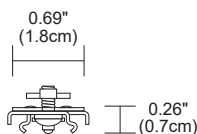
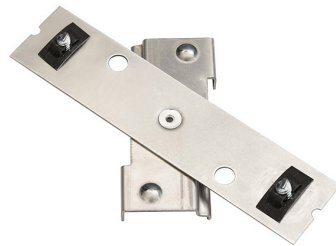

System	Canopy	Type	Finish
<b>ZC</b>	<b>MCL</b>	<b>TBE</b>	<b>WH</b>
ZC Zip Ceiling	MCL Mounting Clip	TBE T-Bar End	WH White BK Black

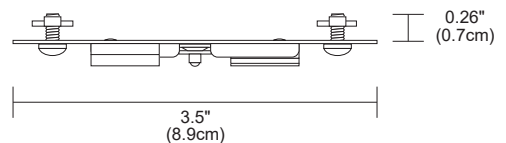

PROJECT		FIXTURE TYPE		DATE	
---------	--	--------------	--	------	--

# ZIP LED BIY (BUILD IT YOURSELF)

CEILING/WALL, 24VDC REMOTE POWER

REV 08.02.21

## INSTALLATION

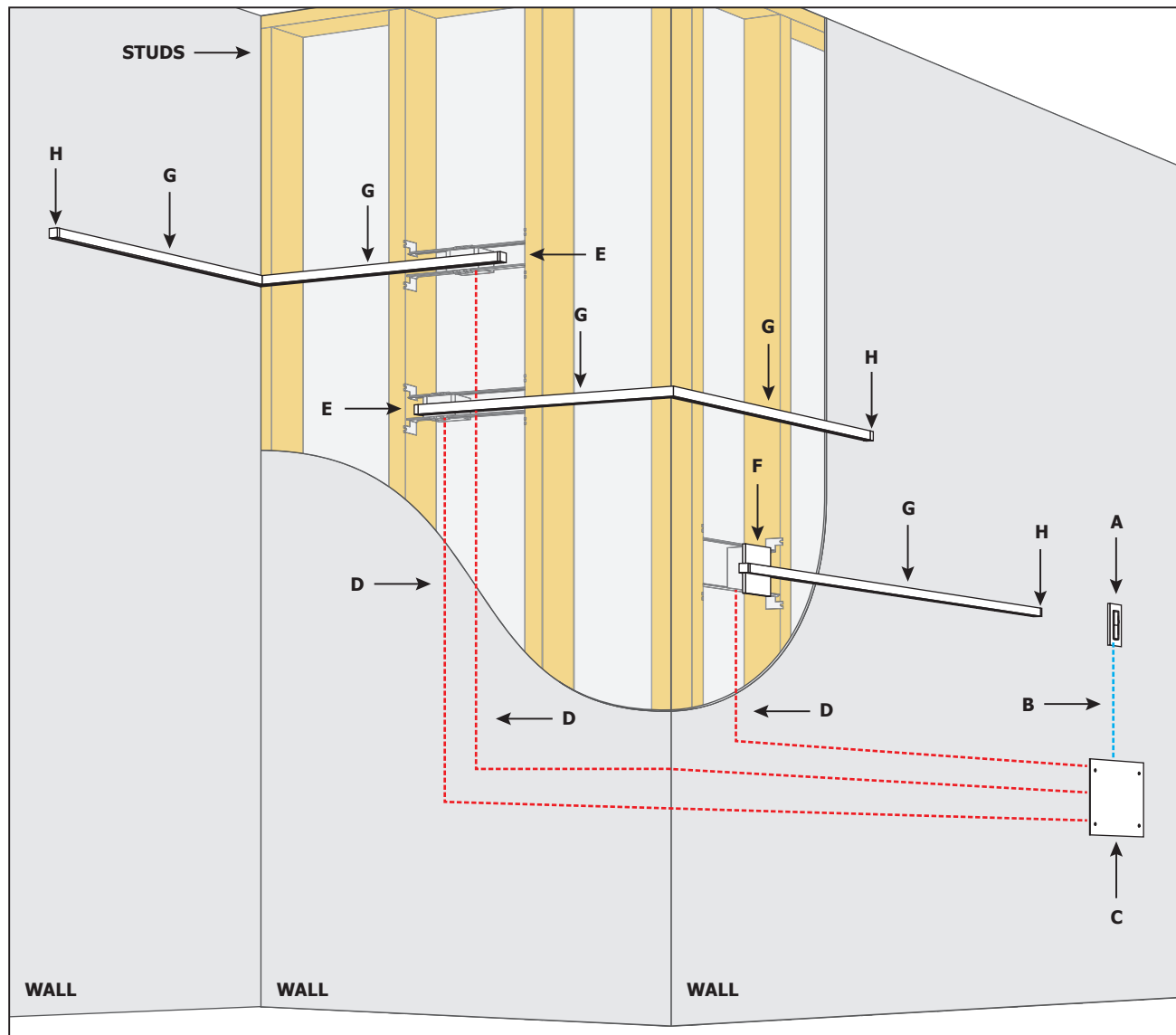

- A. DIMMER OR SWITCH
- B. 120VAC WIRING
- C. 120V/24VDC REMOTE POWER SUPPLY WITH IN-WALL MOUNTING KIT
- D. 24VDC, CLASS 2 WIRING
- E. END CAP POWER CONNECTOR WITH 1" RECTANGLE CANOPY & J-BOX
- F. END CAP POWER CONNECTOR WITH 4.6" SQUARE SPLIT CANOPY
- G. ZIP CHANNEL
- H. DEAD END CAP

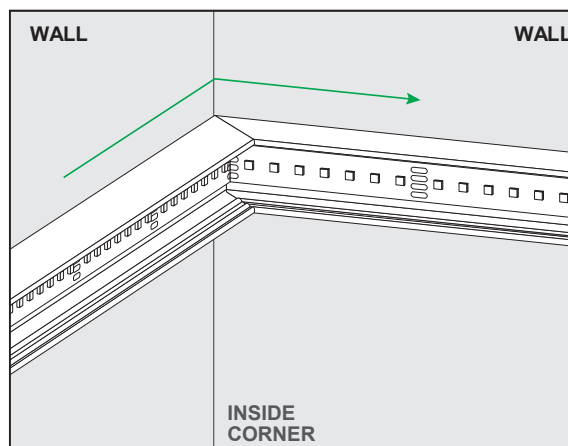

LED on back of the channel

PROJECT	FIXTURE TYPE	DATE
---------	--------------	------

# STOMP STRIP

## 24VDC, STATIC WHITE, WARM DIM & TUNABLE WHITE

DESIGNED BY GREGORY KAY | ASSEMBLED IN AMERICA

REV 08.02.21

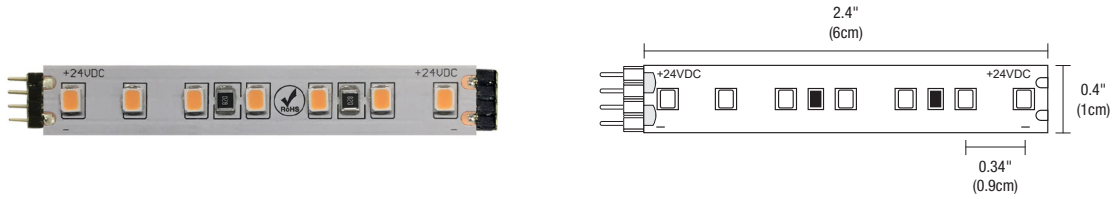

\*Available with pin connectors or soldered leads

### CAN'T STOMP ME OUT

Our Low Voltage BIY (Build-It-Yourself) Stomp Strip is value engineered and highly durable, designed to withstand the harsh elements of a job site, including stomping and twisting. Stomp Strip is used for our BIY fixtures and systems including Truline, Verge & Nova.

### FEATURES & BENEFITS

- 4 Pin Connectors or, Pre-soldered leads reduce time and labor during installation
- Value Engineered: Developed to meet popular demand for cost effective illumination without sacrificing output, color rendering and efficacy
- Tolerance: Created to resist damage in rigorous environments such as busy commercial jobsites
- Compact LED spacing: Produce uniform light distribution without visible diodes or hot spots when used within a diffused lens
- 4oz Layer of Copper Busbar: Provides superior heat dissipation and less voltage drop equivalent to 14AWG wire
- Premium Coating: Optically Clear Silicone prevents fading over time
- Mounting: Industrial 3M tape lined strip for strong, self-adhesion to most smooth, finished surfaces
- Applications: Indoor, damp and dry locations
- Warranty: Includes a 5-year pro-rated warranty

### SPECIFICATIONS

- 24VDC, 120-277VAC Input
- 2.5, 4.4 or 7.5 watts per foot
- Sold in 1 foot increments
- Field-cutable increments: Static White 2.4", Warm Dim and Tunable White 3"
- Operating temperature: -22°F to 140°F (-30°C to 60°C)

### LAMP

- 7 Static White Color Temperatures **22K-57K**
- Warm Dim: **27D** and **30D** dim down to 2000K, resembling incandescent light sources
- Tunable White: **2K6K** and **27K6** allow for independent control of color temperatures and dimming
- Average life: 50,000 hours

### REMOTE POWER SUPPLIES\*, DIMMING & CONTROLS (SOLD SEPARATELY)

- Electronic Low Voltage Dimming (**ELV**)<sup>†</sup>
- Uni Driver: Universal dimming (**ELV, 0-10V, TRIAC**)
- 0-10 Volt (**0-10**) Dimming
- Dynamic Color Changing (**DMX**)
- Lutron Hi-Lume<sup>®</sup>

\*In-Wall Mounting Kits available for select Power Supplies  
<sup>†</sup>With N-Lite Dimming Do Not use ELV power supply's, use only 0-10 volt or Uni drivers power supplies

### MAXIMUM LENGTHS BEFORE RE-FEEDING

- 2WDC, 2.5 watts per foot - 40' (Static White Only)
- 5WDC, 4.4 watts per foot - 20'
- 7WDC, 7.5 watts per foot - 12' (Excludes Warm Dim)

### COMPATIBLE FIXTURES & SYSTEMS

- All PureEdge Lighting BIY channels
- 5/8" Drywall Systems: Truline, Truquad, Reveal and Verge

	ST2A							ST5A							ST7A								
WATTS PER FOOT	2.5W							4.4W							7.5W								
COLOR TEMPERATURE	22K	24K	27K	30K	35K	40K	57K	22K	24K	27K	27D*	30K	30D*	35K	40K	57K	22K	24K	27K	30K	35K	40K	57K
LUMENS PER FOOT (lm/ft)	205	226	249	272	312	340	361	357	393	434	553	474	563	544	592	629	581	641	707	773	887	965	1025
LUMENS PER WATT (lm/w)	82	90	100	109	125	136	144	81	89	99	115	108	117	124	135	143	80	88	97	106	121	132	140
CRI	92+	92+	92+	92+	92+	92+	92+	92+	92+	92+	94+	92+	94+	92+	92+	92+	92+	92+	92+	92+	92+	92+	92+

\*27D, 30D - Warm Dim (4.8 Watts)

	ST5A 2K6K					ST5A 27K6					ST7A 2K6K					ST7A 27K6												
WATTS PER FOOT	4.4W					4.4W					7.5W					7.5W												
COLOR TEMPERATURE	20K	22K	24K	27K	30K	35K	40K	57K	65K	27K	30K	35K	40K	45K	57K	65K	20K	22K	24K	27K	30K	35K	40K	41K	45K	57K	65K	
LUMENS PER FOOT (lm/ft)	389	409	429	449	491	511	530	443	442	411	420	436	452	447	443	442	525	587	648	707	764	814	718	598	596	555	567	589
LUMENS PER WATT (lm/w)	97	89	93	98	107	111	133	96	110	103	91	95	98	97	96	110	82	81	90	98	106	113	112	83	93	87	79	82
CRI	91+	91+	91+	94+	94+	94+	91+	93+	93+	92+	92+	92+	95+	93+	93+	93+	91+	91+	91+	94+	94+	94+	91+	93+	93+	92+	92+	92+



**ST2A** Stomp Strip, 2.5 watts (40ft Max)  
**ST5A** Stomp Strip, 4.4 watts (20ft Max)  
**ST7A** Stomp Strip, 7.5 watts (12ft Max)

Leave blank for no connector

**22K** 2200K Amber White  
**24K** 2400K Very Warm White  
**27K** 2700K Incandescent White  
**27D** 2700K Warm Dim (5W Only)  
**30K** 3000K Warm White  
**30D** 3000K Warm Dim (5W Only)  
**35K** 3500K Neutral White  
**40K** 4000K Cool White  
**57K** 5700K Daylight White  
**2K6K** Tunable White 2000K-6500K (5W & 7W Only)  
**27K6** Tunable White 2700K-6500K (5W & 7W Only)

PROJECT		FIXTURE TYPE		DATE	
---------	--	--------------	--	------	--

# PURE MODULAR COMMERCIAL SOFT STRIP

24VDC, HIGH OUTPUT, STATIC WHITE, WARM DIM, RGB, RGB+W & TUNABLE WHITE

DESIGNED BY GREGORY KAY | ASSEMBLED IN AMERICA

REV 08.02.21

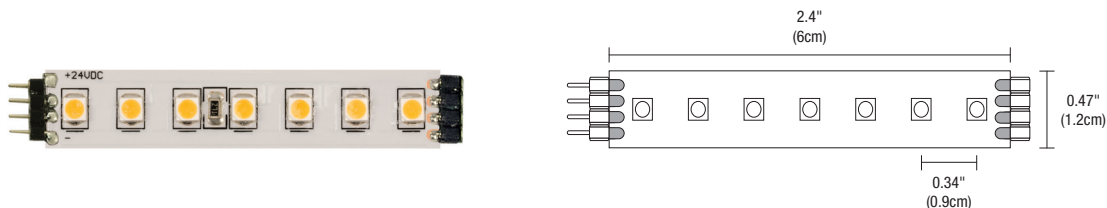

\*Available with pin connectors or soldered leads

Our Premium BIY (Build-It-Yourself) Commercial Grade Pure Modular Soft Strip provides exceptional light output, clarity, and distribution.

## FEATURES & BENEFITS

- High Output and Efficiency: Up to 171 lumens per watt
- Designer Grade Color Rendering up to 95+ CRI
- Gold Plated Contacts: Prevent oxidation ensuring longevity of the LEDs
- 35 LEDs per foot: Tight spacing of LEDs produce uniform light distribution without visible diodes or pixelation when used within a diffused lens
- 4oz Layer of Copper Busbar: Provides superior heat dissipation and less voltage drop equivalent to 14AWG wire
- Premium Coating: Optically Clear Silicone prevents fading over time
- 7 LEDs per 2.4" Increment: 88% efficiency compared to 6 at only 75%
- Solid State Power Supply: Offers 90% efficiency compared to magnetic power supplies at 80%
- The composition of 7 LEDs and Solid State Power increases the efficiency up to 22%
- Mounting: Industrial 3M tape lined strip for strong, self-adhesion to most smooth, finished surfaces
- Applications: Indoor, damp and dry locations
- Warranty: Includes a 5-year pro-rated warranty

## SPECIFICATIONS

- 24VDC, 120-277VAC Input
- 2.5, 4.4, 7.3 and 9.6 watts
- Sold in 1' long increments
- Field-cutttable increments: Static White and RGB 2.4"; Warm Dim, Tunable White and RGBW 3"
- Operating temperature: -22°F to 140°F (-30°C to 60°C)

## LAMP

- 7 Static White Color Temperatures **22K-57K**
- Warm Dim: **27D** and **30D** dim down to 1900K, similar to halogen and incandescent light sources
- Dynamic/Tunable White: **2K6K** and **27K6** allow for independent control of color temperatures and Brightness
- RGB & RGB+W (**2000K**)
- Designer Grade High CRI 95+ LEDs
- 120 degree beam angle
- Average life: 50,000 hours

## MAXIMUM LENGTHS BEFORE RE-FEEDING

- 2WDC - 40' (Static White Only)
- 5WDC - 20' (Excludes RGB+W)
- 6WDC - 15' (RGB+W Only)
- 7WDC - 12' (Static & Tunable White Only)
- 10WDC - 10' (Static and Tunable White Only)

## COMPATIBLE FIXTURES & SYSTEMS

All PureEdge Lighting BIY channels 5/8" Drywall Systems: Truline, Truquad, Reveal, Verge and Nova

## REMOTE POWER SUPPLIES\*, DIMMING & CONTROLS (SOLD SEPARATELY)

- Uni Driver: Universal dimming (**ELV, 0-10V, TRIAC**)
- Electronic Low Voltage Dimming (**ELV**)<sup>†</sup>
- 0-10 Volt (**0-10**) Dimming
- Dynamic Color Changing (**DMX**)
- Lutron Hi-Lume<sup>®</sup>

\*In-Wall Mounting Kits available for select Power Supplies

<sup>†</sup>With N-Lite Dimming Do Not use ELV power supply's, use only 0-10 volt or Uni drivers power supplies

	PL2C							PL5C							PL7C							PL10C								
WATTS PER FOOT	2.5W							4.4W							7.3W							9.6W								
COLOR TEMPERATURE	22K	24K	27K	30K	35K	40K	57K	22K	24K	27K	27D*	30K	30D*	35K	40K	57K	22K	24K	27K	30K	35K	40K	57K	22K	24K	27K	30K	35K	40K	57K
LUMENS PER FOOT (lm/ft)	242	268	295	323	370	402	428	418	464	510	632	557	631	638	694	738	683	758	834	911	1043	1134	1207	885	983	1080	1180	1352	1470	1564
LUMENS PER WATT (lm/w)	97	107	118	129	148	161	171	95	105	115	132	126	132	145	157	167	94	104	114	125	143	155	165	92	102	112	123	140	153	163
CRI	85+	90+	95+	95+	85+	85+	85+	85+	90+	95+	92+	95+	92+	85+	85+	85+	85+	90+	95+	95+	85+	85+	85+	90+	95+	95+	85+	85+	85+	85+

\*27D, 30D - Warm Dim (4.8 Watts)

	PL5C 2K6K							PL5C 27K6							PL10C 2K6K							PL10C 27K6										
WATTS PER FOOT	4.6W							4.6W							9.6W							9.6W										
COLOR TEMPERATURE	20K	22K	24K	27K	30K	35K	40K	57K	65K	27K	30K	35K	40K	45K	57K	65K	20K	22K	24K	27K	30K	35K	40K	57K	65K	27K	30K	35K	40K	45K	57K	65K
LUMENS PER FOOT (lm/ft)	412	434	455	476	520	541	562	535	518	516	531	547	563	541	535	518	720	793	866	1011	1052	1076	957	1017	984	981	1009	1039	1069	1028	1017	984
LUMENS PER WATT (lm/w)	103	94	99	104	113	118	141	134	132	130	133	133	131	132	134	132	90	94	98	105	114	117	120	111	123	123	110	113	116	112	111	123
CRI	83+	83+	92+	92+	92+	94+	94+	93+	93+	93+	93+	94+	94+	94+	93+	93+	83+	83+	92+	92+	92+	94+	94+	93+	93+	93+	93+	94+	94+	94+	93+	93+

System	Type	Voltage	Length in Feet	Color Temperature
<b>PL2C</b>	<b>4PIN-6A</b>	<b>24V</b>	<b>40</b>	<b>27K</b>
<b>PL2C</b> Pure Modular Commercial, 2.5 Watts (40ft Max) <b>PL5C</b> Pure Modular Commercial, 4.4 Watts (20ft Max) <b>PL6</b> Pure Modular Commercial, 6.3 Watts (15ft Max, RGBW Only)* <b>PL7C</b> Pure Modular Commercial, 7.5 Watts (12ft Max) <b>PL10C</b> Pure Modular Commercial, 9.6 watts (10ft Max)	<b>4PIN</b> 4 Pin <b>5PIN</b> 5 Pin (RGBW Only)	<b>24V</b> 24 Volt	<b>1-40</b>	<b>22K</b> 2200K Amber White <b>24K</b> 2400K Very Warm White <b>27K</b> 2700K Incandescent White <b>27D</b> 2700K Warm Dim (5W Only) <b>30K</b> 3000K Warm White <b>30D</b> 3000K Warm Dim (5W Only) <b>35K</b> 3500K Neutral White *RGBW is PL6 Only <b>40K</b> 4000K Cool White <b>57K</b> 5700K Daylight White <b>RGB</b> Red, Green and Blue (5W only) <b>RGBW</b> Red, Green, Blue and White (6W only)* <b>2K6K</b> Tunable White 2000K-6500K (5W+10W Only) <b>27K6</b> Tunable White 2700K-6500K (5W+10W Only)

\*PL6 is RGBW Only

PROJECT	FIXTURE TYPE	DATE
---------	--------------	------



# ADDITIONAL COMPONENTS

REV 08.02.21

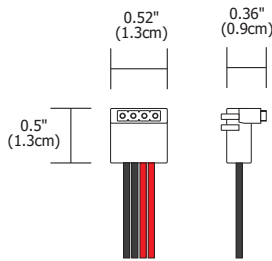

## B90 POWER END FEED (INCLUDED, OR ORDER AS EXTRA PARTS)

24VDC, Class 2, 4Pin 14GA, 8", 90°.

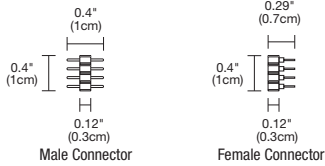
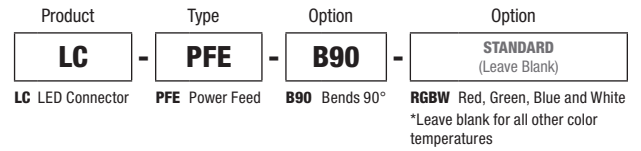

## EXTRA PIN CONNECTORS (INCLUDED, OR ORDER AS EXTRA PARTS)

Extra soldering pin connectors. Male and female.

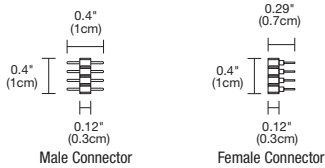
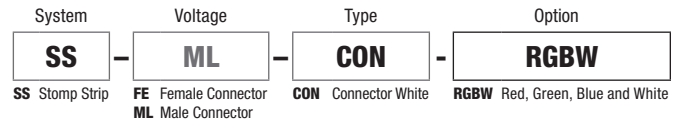

## EXTRA PIN CONNECTORS (INCLUDED, OR ORDER AS EXTRA PARTS)

Extra soldering pin connectors. Male and female.

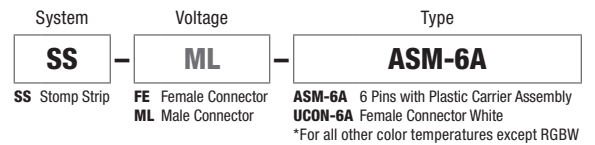

**APPROVALS:** Class 2 Wiring up to 100 watts, Damp Location Suitable, ETL listed.

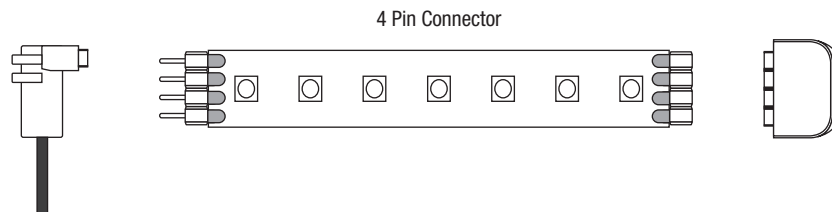
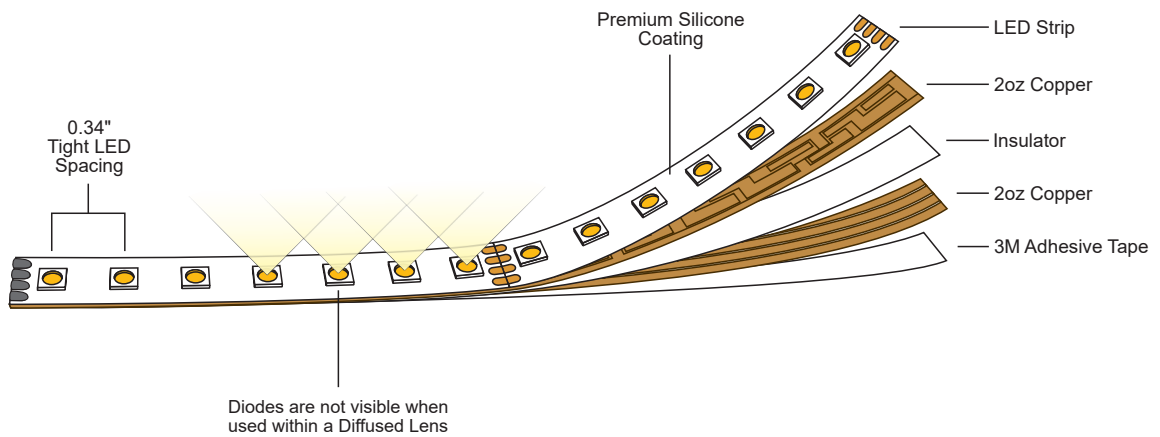

PROJECT	FIXTURE TYPE	DATE
---------	--------------	------

# ZIP LED BIY (BUILD IT YOURSELF)

CEILING/WALL, 24VDC REMOTE POWER

REV 08.02.21

## LENGTH CHART Actual lengths for Zip Ceiling/Wall BIY

2.5 WATTS PER FOOT							
LENGTH IN FEET	WATTS	LENGTH IN FEET	WATTS	LENGTH IN FEET	WATTS	LENGTH IN FEET	WATTS
1	3	11	27	21	51	31	75
2	5	12	29	22	54	32	78
3	8	13	32	23	56	33	80
4	10	14	34	24	58	34	82
5	13	15	37	25	61	35	85
6	15	16	39	26	63	36	87
7	17	17	41	27	66	37	90
8	20	18	44	28	68	38	92
9	22	19	46	29	70	39	94
10	24	20	48	30	72	40	96

5 WATTS PER FOOT							
LENGTH IN FEET	WATTS	LENGTH IN FEET	WATTS	LENGTH IN FEET	WATTS	LENGTH IN FEET	WATTS
1	5	6	30	11	54	16	78
2	10	7	34	12	58	17	82
3	16	8	40	13	64	18	88
4	20	9	44	14	68	19	92
5	24	10	48	15	72	20	96

6 WATTS PER FOOT - RGBW LEDS							
LENGTH IN FEET	WATTS	LENGTH IN FEET	WATTS	LENGTH IN FEET	WATTS	LENGTH IN FEET	WATTS
1	6	5	30	9	54	13	78
2	12	6	36	10	60	14	84
3	18	7	42	11	66	15	90
4	24	8	48	12	72	16	96

7.5 WATTS PER FOOT							
LENGTH IN FEET	WATTS	LENGTH IN FEET	WATTS	LENGTH IN FEET	WATTS	LENGTH IN FEET	WATTS
1	8	4	30	7	53	10	75
2	15	5	38	8	60	11	83
3	23	6	45	9	68	12	90

PROJECT		FIXTURE TYPE		DATE	
---------	--	--------------	--	------	--

### 0-10 VOLT (010) POWER SUPPLIES & RECOMMENDED DIMMERS

ORDERING CODE	PSB-25W-010-24VDC	PSB-60W-010-24VDC	PSB-96W-010-24VDC
SPECIFICATIONS			
MAXIMUM LOAD	25W	60W	96W
INPUT VOLTAGE	120-277VAC	120-277VAC	120-277VAC
OUTPUT VOLTAGE	24VDC	24VDC	24VDC
DIMENSIONS	12.4" X 3.12" X 2.18"	12.4" X 3.12" X 2.18"	12.4" X 3.12" X 2.18"
CLASSIFICATION	CLASS 2	CLASS 2	CLASS 2
T-BAR MOUNTING	PSB-25W-010-24VDC-TB	PSB-60W-010-24VDC-TB	PSB-96W-010-24VDC-TB
IN-WALL MOUNTING	PSB-25W-010-24VDC-IW	PSB-60W-010-24VDC-IW	PSB-96W-010-24VDC-IW

### 0-10 VOLT (010) POWER SUPPLIES & RECOMMENDED DIMMERS

ORDERING CODE	PSB-2X96W-010-24VDC	PSB-3X96W-010-24VDC	PSB-4X96W-010-24VDC
SPECIFICATION			
MAXIMUM LOAD	2X96W	3X96W	4X96W
INPUT VOLTAGE	120-277VAC	120-277VAC	120-277VAC
OUTPUT VOLTAGE	24VDC	24VDC	24VDC
DIMENSIONS	12.15" X 6.48" X 2.18"	14" X 10" X 3"	17" X 13" X 3"
CLASSIFICATION	CLASS 2	CLASS 2	CLASS 2
T-BAR MOUNTING	PSB-2X96W-010-24VDC-TB	PSB-3X96W-010-24VDC-TB	PSB-4X96W-010-24VDC-TB
IN-WALL MOUNTING	PSB-2X96W-010-24VDC-IW	N/A	N/A

### DIMMING & CONTROLS

PHILIPS SUNRISE: SR1200ZTUNV	•	•	•
LUTRON DIVA: DVTV-WH, DVSTV-WH	•	•	•
LUTRON NOVA T: NTSTV-DV-XX	•	•	•
LUTRON GRAFIX EYE QS: QSGRJ-XP	•	•	•
LUTRON RADIO RA2: RRD-10ND	•	•	•
LEVITON: LEV40050	•	•	•
LEVITON IP710-LFZ	•	•	•
LEGRAND: ADPD4FBL3P2W4	•	•	•

- Flicker free dimming
- Aluminum casing for optimal heat dissipation
- Isolated output power per NEC and UL safety requirements
- UL & ETL recognized/ listed, meets UL 8750, 1310 requirements

- Auto-reset; short circuit, overload and thermal protection
- Class 2 power supply
- Efficient, High power factor > 90

\*Title 24 compliant when used with JAB listed PureEdge systems.

\*\*Up + Down Light fixtures and Systems can be controlled individually or together depending on the power supply selection.

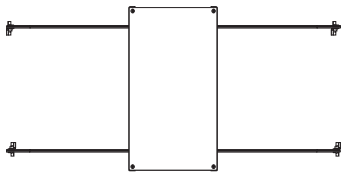

**T-BAR Mounting Kit:** Includes power supply, box cover, and T-bar hangers for installing Junction Box above ceiling with in easy reach. Comes with 4' of 14 gauge pair Teflon cables with quick secure connectors.

**Ordering Codes:**

- PSB-25W-010-24VDC-TB,
- PSB-60W-010-24VDC-TB,
- PSB-96W-010-24VDC-TB,
- PSB-2X96W-010-24VDC-TB
- PSB-3X96W-010-24VDC-TB
- PSB-4X96W-010-24VDC-TB

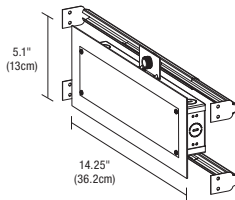

**5.1" x 14.25" In-Wall Mounting Kit:** Includes power supply, box cover and stud hangers for installing Junction Box in wall. Select "IW" in the options section of compatible power supply ordering codes if an In-Wall Mounting Kit is needed.

**Ordering Codes:** PSB-25W-010-24VDC-IW, PSB-60W-010-24VDC-IW, PSB-96W-010-24VDC-IW

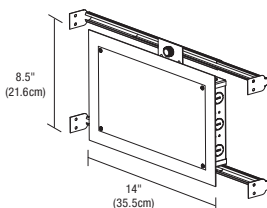

**8.5" x 14" In-Wall Mounting Kit:** Includes power supply, box cover and stud hangers for installing Junction Box in wall. Select "IW" in the options section of compatible power supply ordering codes if an In-Wall Mounting Kit is needed.

**Ordering Codes:** PSB-2X96W-010-24VDC-IW

PROJECT	FIXTURE TYPE	DATE
---------	--------------	------

**SAMPLE WIRING DIAGRAMS 24VDC 010**

**Application:** 0-10V Dimming Applications For Static White and Warm Dim

**Dimming:** Dimmable with 0-10V dimmers: Signify (Phillips) Sunrise: SR1200ZTUNV, Leviton Dimmers: LEV40050, IP710-LFZ, \*IP710-DLZ \*(Built in LED locator light) Legrand Dimmer: ADPD4FBL3P2W4 Lutron Systems: Lutron GRAFIX Eye QS Main Unit (with DRX-TVI) Radio Ra2 (with GRX-TVI)

**0-10V DIMMER**

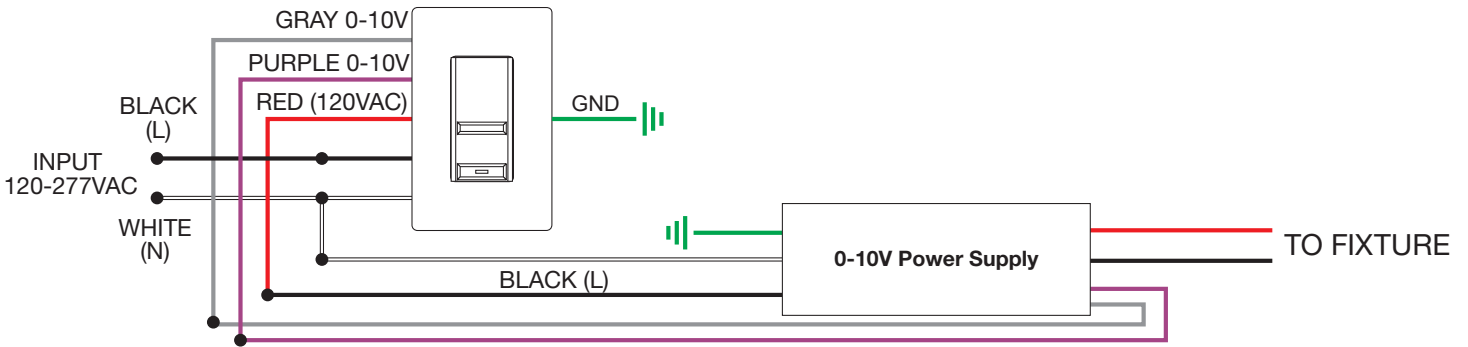

**Application:** Dual 0-10V dimming for Static White

**Dimming:** Dimmable with Dual 0-10V dimmers: Signify (Phillips) Sunrise: SR1200ZTUNV, Leviton Dimmers: LEV40050, IP710-LFZ, \*IP710-DLZ \*(Built in LED locator light), Legrand Dimmer: ADPD4FBL3P2W4, Lutron Systems: Lutron GRAFIX Eye QS Main Unit (with DRX-TVI) Radio Ra2 (with GRX-TVI)

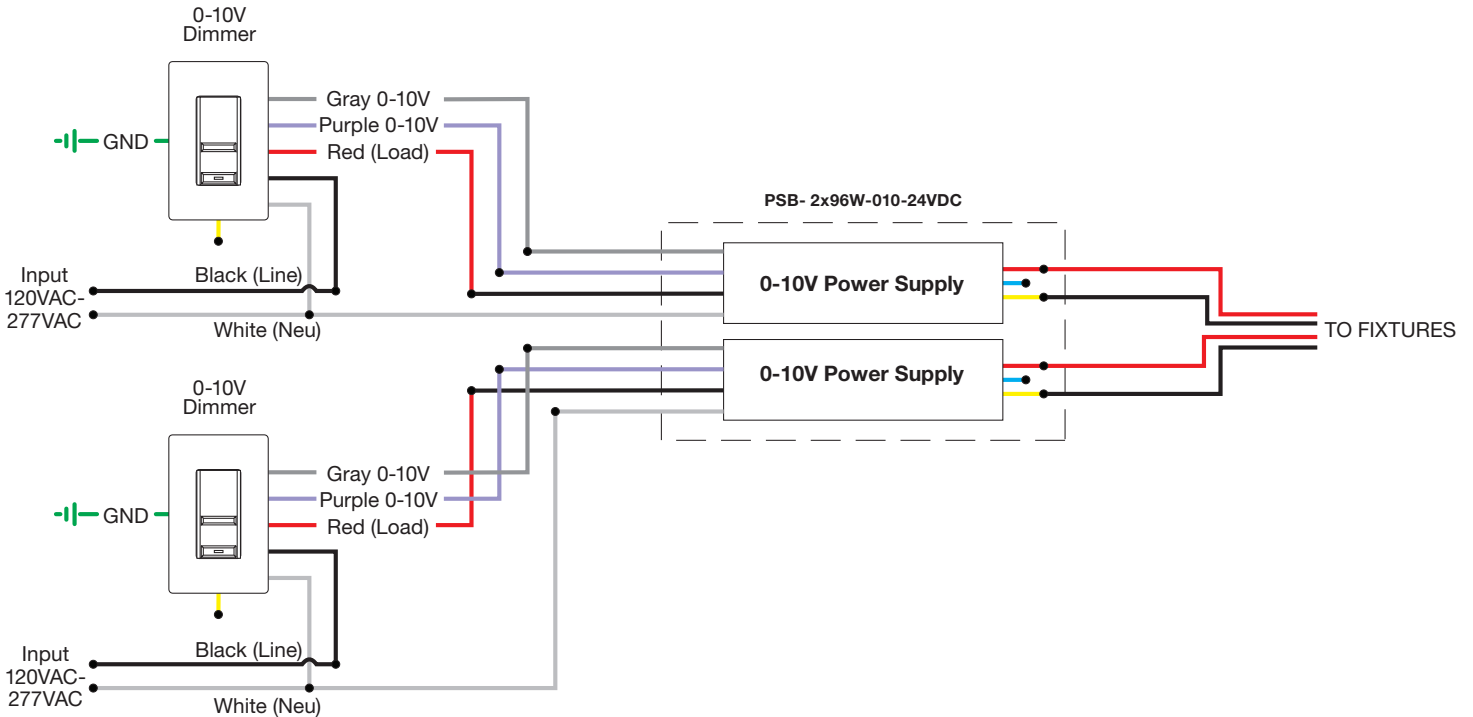

PROJECT		FIXTURE TYPE		DATE	
---------	--	--------------	--	------	--

# INDOOR CONSTANT VOLTAGE REMOTE POWER SUPPLIES

24VDC, UNIVERSAL DIMMING WITH ELV, TRIAC, & 0-10V FOR STATIC WHITE, WARM DIM

UNIVERSAL POWER SUPPLIES & RECOMMENDED DIMMERS				
ORDERING CODE	PSB-40W-UNI-24VDC	PSB-60W-UNI-24VDC	PSB-2X40W-UNI-24VDC	PSB-2X60W-UNI-24VDC
SPECIFICATIONS				
MAXIMUM LOAD	40W	60W	2X40W	2X60W
INPUT VOLTAGE	120-277VAC	120-277VAC	120-277VAC	120-277VAC
OUTPUT VOLTAGE	24VDC	24VDC	24VDC	24VDC
DIMENSIONS	12.4" X 3.12" X 2.18"	12.4" X 3.12" X 2.18"	12.15" X 6.48" X 2.18"	12.15" X 6.48" X 2.18"
CLASSIFICATION	CLASS 2	CLASS 2	CLASS 2	CLASS 2
T-BAR MOUNTING	PSB-40W-UNI-24VDC-TB	PSB-60W-UNI-24VDC-TB	PSB-2X40W-UNI-24VDC-TB	PSB-2X60W-UNI-24VDC-TB
IN-WALL MOUNTING	PSB-40W-UNI-24VDC-IW	PSB-60W-UNI-24VDC-IW	PSB-2X40W-UNI-24VDC-IW	PSB-2X60W-UNI-24VDC-IW
UNIVERSAL POWER SUPPLIES & RECOMMENDED DIMMERS				
ORDERING CODE	PSB-96W-UNI-24VDC	PSB-2X96W-UNI-24VDC	PSB-3X96W-UNI-24VDC	PSB-4X96W-UNI-24VDC
SPECIFICATIONS				
MAXIMUM LOAD	96W	2X96W	3X96W	4X96W
INPUT VOLTAGE	120-277VAC	120-277VAC	120-277VAC	120-277VAC
OUTPUT VOLTAGE	24VDC	24VDC	24VDC	24VDC
DIMENSIONS	12.4" X 3.12" X 2.18"	12.15" X 6.48" X 2.18"	14" X 10" X 3"	17" X 13" X 3"
CLASSIFICATION	CLASS 2	CLASS 2	CLASS 2	CLASS 2
T-BAR MOUNTING	PSB-96W-UNI-24VDC-TB	PSB-2X96W-UNI-24VDC-TB	PSB-3X96W-UNI-24VDC-TB	PSB-4X96W-UNI-24VDC-TB
IN-WALL MOUNTING	PSB-96W-UNI-24VDC-IW	PSB-2X96W-UNI-24VDC-IW	NA	NA
ELV DIMMING & CONTROLS				
LUTRON DIVA: DVELV-300P	•	•	•	•
LUTRON SKYLARK: SELV-300P	•	•	•	•
LUTRON RADIO RA2: RRD-6NA	•	•	•	•
LUTRON MAESTRO: MAELV-600	•	•	•	•
LEGRAND ADORNE: ADTP-703TUM4	•	•	•	•
0-10 DIMMING & CONTROLS				
PHILIPS SUNRISE: SR1200ZTUNV	•	•	•	•
LUTRON DIVA: DVTV-WH, DVSTV-WH	•	•	•	•
LUTRON NOVA T: NTSTV-DV-XX	•	•	•	•
LUTRON GRAFIX EYE QS: QSGRJ-XP	•	•	•	•
LUTRON RADIO RA2: RRD-10ND	•	•	•	•
LEVITON: LEV40050	•	•	•	•
LEVITON IP710-LFZ	•	•	•	•
LEGRAND: ADPD4FBL3P2W4	•	•	•	•
TRIAC DIMMING & CONTROLS				
LUTRON SKYLARK: S2-L-WH	•	•	•	•
LUTRON DIVA DVLV-600P-WH	•	•	•	•
LUTRON DIVA DVLV-603P-WH	•	•	•	•
LUTRON MAESTRO MALV-600-WH	•	•	•	•
LUTRON MAESTRO MALV-1000-WH	•	•	•	•
LUTRON MAESTRO MA-R-XX	•	•	•	•

- Flicker free dimming
- Aluminum casing for optimal heat dissipation
- Isolated output power per NEC and UL safety requirements
- UL & ETL recognized/ listed, meets UL 8750, 1310 requirements
- Auto-reset; short circuit, overload and thermal protection
- Class 2 power supply
- Efficient, High power factor > 0.90

- The Solid State Constant Voltage Uni-Power Supply is compatible with most commercially available Dimmers:
  - Triac Dimmer: (Forward Phase) Typically used for the dimming of Incandescent and Low Voltage Magnetic Transformers
  - ELV Dimmer: (Reverse Phase) Dimming of Electronic Low Voltage Transformers and Power Supplies used for LED lighting
  - 0-10 Dimmer: Dims the Low Voltage side of a 0-10 volt power supply commonly used in large scale lighting or commercial applications.
- The Uni-Power Supply is recommended with any Siemens/Murray brand of arc fault breaker to overcome the issues with tripping the breakers with an ELV LED Low Voltage Drivers.

\*Title 24 with JAB listed PureEdge products and systems

\*Tunable White requires Dual power Supplies and Controls. For single control use with our proprietary Tunable White Controller CDMX-1, refer to Universal Tunable White Power Supply Specifications. Up + Down Light fixtures and Systems can be controlled individually or together depending on the power supply selection.

**T-BAR Mounting Kit:** Includes power supply, box cover, and T-bar hangers for installing Junction Box above ceiling with in easy reach. Comes with 4' of 14 gauge pair Teflon cables with quick secure connectors.

**Ordering Codes :** PSB-40W-UNI-24VDC-TB, PSB-60W-UNI-24VDC-TB, PSB-96W-UNI-24VDC-TB, PSB-2X40W-UNI-24VDC-TB, PSB-2X60W-UNI-24VDC-TB, PSB-2X96W-UNI-24VDC-TB, PSB-3X96W-UNI-24VDC-TB, PSB-4X96W-UNI-24VDC-TB

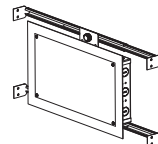
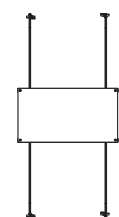

**In-Wall Mounting Kit:** Includes power supply, box cover and stud hangers for installing Junction Box in wall. Select "IW" in the options section of compatible power supply ordering codes if an In-Wall Mounting Kit is needed.

**Ordering Codes 5.1" x 14.25":** PSB-40W-UNI-24VDC-IW, PSB-60W-UNI-24VDC-IW, PSB-96W-UNI-24VDC-IW

**Ordering Codes 8.5" x 14.25":** PSB-2X40W-UNI-24VDC-IW, PSB-2X60W-UNI-24VDC-IW, PSB-2X96W-UNI-24VDC-IW

PROJECT		FIXTURE TYPE		DATE	
---------	--	--------------	--	------	--

**WIRING DIAGRAMS UNIVERSAL POWER SUPPLY**

**Application:** ELV dimming for Static White and Warm Dim

**Dimming:** Dimmable with ELV dimmer: Legrand, Adorne ADTP703TU; Lutron: Diva DVELV-300P, Skylark SELV-300P, Maestro MAELV-600 and Radio Ra 2

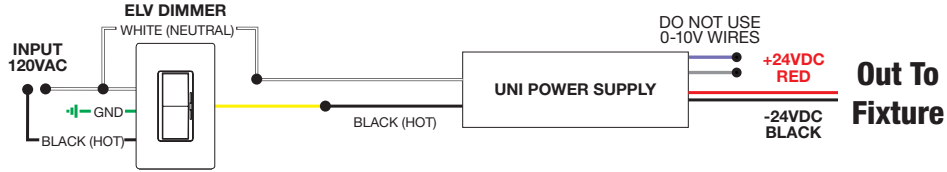

**Application:** 0-10V dimming for Static White

**Dimming:** Dimmable with 0-10V dimmer: Philips Sunrise: SR1200ZTUNV; Lutron Diva: DVTV-WH, DVSTV-WH; Lutron Nova T: NTSTV-DV-XX; Lutron Grafix EYE QS: QSGRJ-XP; Lutron Radio Ra2: RRD-10ND; Leviton: LEV40050; Leviton IP710-LFZ; Legrand: ADPD4FBL3P2W4

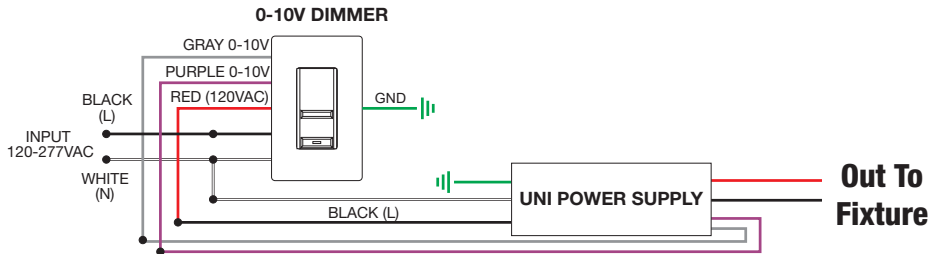

**Application:** Triac dimming for two power supplies, use for Static White

**Dimming:** Dimmable with Triac dimmer: Lutron: Skylark S2-L

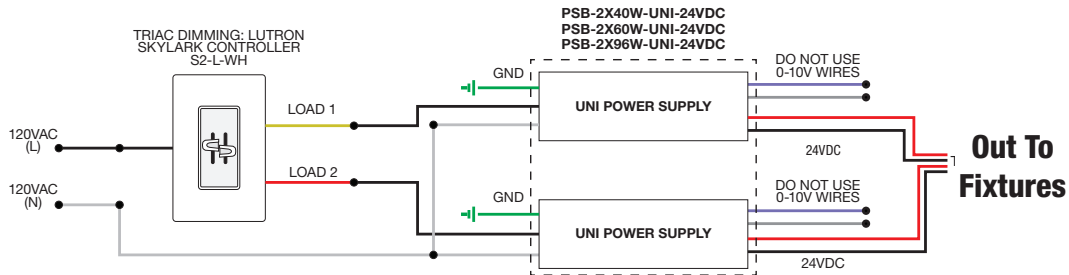



PROJECT		FIXTURE TYPE		DATE	
---------	--	--------------	--	------	--

# INDOOR CONSTANT VOLTAGE REMOTE POWER SUPPLIES

24VDC, LUTRON ECOSYSTEM

## LUTRON HI-LUME® PREMIER .1% ECOSYSTEM®†

ORDERING CODES	L3D0-96W24V-U	2-WIRE ECOSYSTEM LTEA4U1UKL-CV240	3-WIRE ECOSYSTEM L3DA4U1UKL-CV240
			
<b>SPECIFICATIONS</b>			
<b>MAXIMUM LOAD</b>	96W	5W-40W	5W-40W
<b>INPUT VOLTAGE</b>	120-277VAC	120-277VAC	120-277VAC
<b>OUTPUT VOLTAGE</b>	24VDC	24VDC	24VDC
<b>DIMENSIONS</b>	10.5" X 5.5" X 2"	4" X 4.89" X 2.62"	4" X 4.89" X 2.62"
<b>CLASSIFICATION</b>	CLASS 2	CLASS 2	CLASS 2
<b>T-BAR MOUNTING</b>	<b>L3D0-96W24V-U-TB</b>	NA	NA
<b>DIMMING AND CONTROLS</b>			
<b>RADIO RA2</b>	•	•	•
<b>HOMEWORKS QS</b>	•	•	•
<b>PHPM-3F-120</b>	•	•	•
<b>PHPM-3F-DV</b>	•	•	•
<b>BCI-0-10</b>	•	•	•

†24K - 57K color temperatures are compatible with 0-10V, ELV, and Lutron Hi-lume® Power Supplies. Warm Dim (27D, 30D) color temperatures are only compatible with ELV power supplies.

2-Wire EcoSystem Wiring Diagram

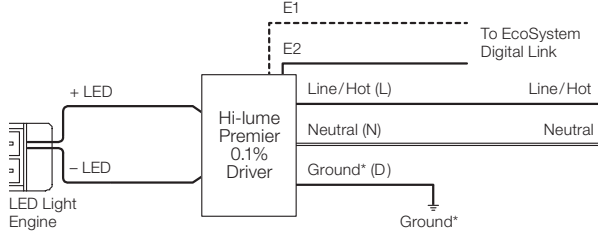

LTEA4U1UKL-CV240

3-Wire Wiring Diagram

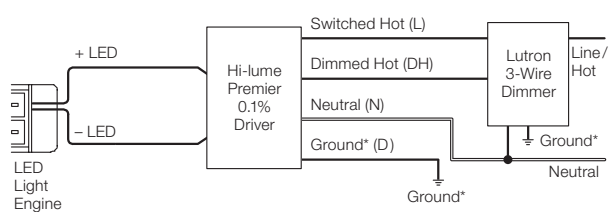

L3DA4U1UKL-CV240

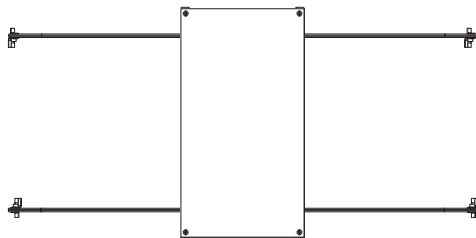

**T-BAR Mounting Kit:** Includes power supply, box cover, and T-bar hangers for installing Junction Box above ceiling with in easy reach. Comes with 4ft of 14 gauge pair Teflon cables with quick secure connectors.

**Ordering Code:** L3D0-96W24V-U-TB

PROJECT	FIXTURE TYPE	DATE
---------	--------------	------

# TUNABLE WHITE DMX CONTROLLER AND POWER SUPPLIES

24VDC INDOOR CONSTANT VOLTAGE POWER SUPPLIES WITH DRIVERS

REV 08.02.21

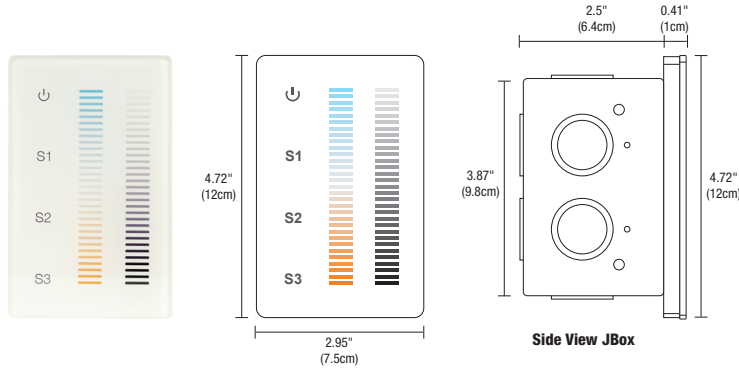

## DESCRIPTION:

The Tunable White Touch Controller offers fast and accurate Color Temperature adjustment and the ability to regulate the Brightness Independently. The modern Glass faceplate features illuminated indicators, and a back-lit night light that softly illuminates the controller when powered off. Designed for Tunable White, and dual-color LED installations within a single zone. The two Vertical Touch sliders are precise and sensitive, allowing you to fine-tune your perfect Color Temperature at any point between **2000K** (Sunset) to **6500K** (Daylight White) while selecting over 250 levels of Brightness in a smooth, uninterrupted transition. Create Thousands of White Color Combinations while maintaining even Brightness and overall saturation. Easily save three pre-set scenes for different times of the day. Support health, performance, and general well-being using Human-Centric lighting by fine-tuning the biological effects that light has on the circadian cycle using the latest in LED technology. Includes a power adapter that fits behind the controller within a standard junction box and fits inside a standard single-gang receptacle (not for use in a multi-gang box). Use with an insulated, 24 AWG stranded, tinned copper wire (Belden #9841). Power Supplies are Sold Separately. Includes a 5 year pro-rated warranty.

## APPLICATIONS:

Indoor

## OUTPUT SIGNAL:

USITT DMX 512 (1990)

## INSTALLATION:

Fits in a single gang 2.5" deep junction box. Not compatible with multi-gang boxes.

## LABELS:

ROHS, FCC, Damp Location, ETL/UL

## POWER INPUT:

120-240VAC

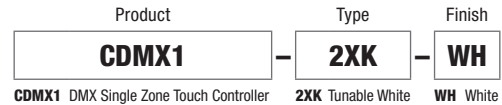
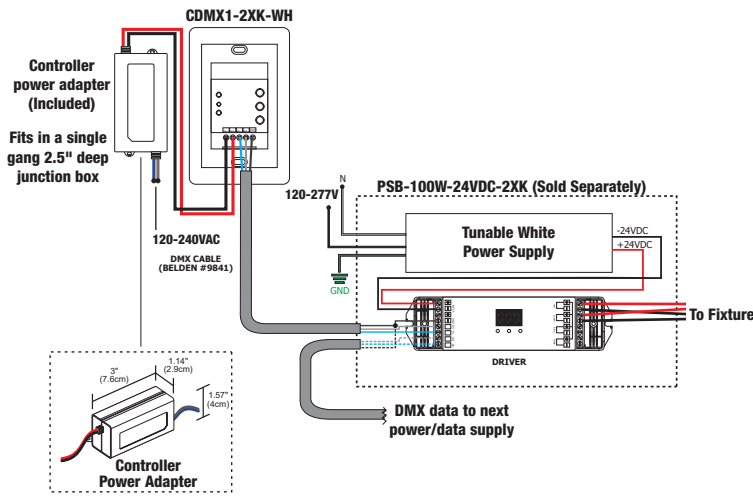

## COLOR CHANGING (DMX) POWER SUPPLIES

ORDERING CODE	PSB-100W-24VDC-2XK	PSB-2X100W-24VDC-2XK	PSB-3X100W-24VDC-2XK	PSB-4X100W-24VDC-2XK
<b>SPECIFICATIONS</b>				
<b>MAXIMUM LOAD OF LED STRIP LENGTH</b>	100W 5 WATTS - 20FT MAX. 10 WATTS - 10FT MAX.	2X100W 5 WATTS 2 X 20FT MAX. 10 WATTS - 2 X 10FT MAX.	3X100W 5 WATTS 3 X 20FT MAX. 10 WATTS - 3 X 10FT MAX.	4X100W 5 WATTS 4 X 20FT MAX. 10 WATTS - 4 X 10FT MAX.
<b>INPUT VOLTAGE</b>	120-277VAC	120-277VAC	120-277VAC	120-277VAC
<b>OUTPUT VOLTAGE</b>	24VDC	24VDC	24VDC	24VDC
<b>DIMENSIONS</b>	12.4" X 6.48" X 2.18"	14" X 10" X 3"	17" X 10" X 3"	17" X 10" X 3"
<b>CLASSIFICATION</b>	CLASS 2	CLASS 2	CLASS 2	CLASS 2
<b>T-BAR MOUNTING</b>	PSB-100W-24VDC-2XK-TB	PSB-2X100W-24VDC-2XK-TB	PSB-3X100W-24VDC-2XK-TB	PSB-4X100W-24VDC-2XK-TB
<b>IN-WALL MOUNTING</b>	PSB-100W-24VDC-2XK-IW	NA	NA	NA
<b>DMX TUNABLE WHITE DIMMING &amp; CONTROLS</b>				
<b>TUNABLE WHITE TOUCH CONTROLLER (CDMX1-2XK)</b>	•	•	•	•

- Flicker free dimming
- Aluminum casing for optimal heat dissipation
- Isolated output power per NEC and UL safety requirements
- UL & ETL recognized/ listed, meets UL 8750, 1310 requirements

- Auto-reset; short circuit, overload and thermal protection
- Class 2 power supply
- Efficient, High power factor > 0.90

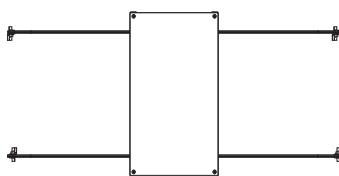

**T-BAR Mounting Kit:** Includes power supply, box cover, and T-bar hangers for installing Junction Box above ceiling with in easy reach. Comes with 4ft of 14 gauge pair Teflon cables with quick secure connectors.

**Ordering Codes:**  
 PSB-100W-24VDC-2XK-TB  
 PSB-2x100W-24VDC-2XK-TB  
 PSB-3x100W-24VDC-2XK-TB  
 PSB-4x100W-24VDC-2XK-TB

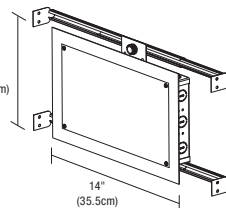

**8.5" x 14" In-Wall Mounting Kit:** Includes power supply, box cover and stud hangers for installing Junction Box in wall. Select "IW" in the options section of compatible power supply ordering codes if an In-Wall Mounting Kit is needed.

**Ordering Codes:**  
 PSB-100W-24VDC-2XK-IW

PROJECT	FIXTURE TYPE	DATE
---------	--------------	------



# INDOOR DMX RGB/RGBW 24VDC CONSTANT VOLTAGE

24VDC WITH DMX DRIVER, RGB & RGB+W

## COLOR CHANGING (DMX) POWER SUPPLIES & RECOMMENDED CONTROLLERS

ORDERING CODE	PSB-100W-24VDC-RGB	PSB-2X100W-24VDC-RGB	PSB-3X100W-24VDC-RGB	PSB-4X100W-24VDC-RGB
<b>SPECIFICATIONS</b>				
<b>MAXIMUM LOAD</b>	100W	2X100W	3X100W	4X100W
<b>INPUT VOLTAGE</b>	120-277VAC	120-277VAC	120-277VAC	120-277VAC
<b>OUTPUT VOLTAGE</b>	24VDC	24VDC	24VDC	24VDC
<b>DIMENSIONS</b>	12.14" X 6.48" X 2.18"	14" X 10" X 3"	17" X 13" X 3"	17" X 13" X 3"
<b>CLASSIFICATION</b>	CLASS 2	CLASS 2	CLASS 2	CLASS 2
<b>T-BAR MOUNTING</b>	<b>PSB-100W-24VDC-RGB-TB</b>	<b>PSB-2X100W-24VDC-RGB-TB</b>	<b>PSB-3X100W-24VDC-RGB-TB</b>	<b>PSB-4X100W-24VDC-RGB-TB</b>
<b>IN-WALL MOUNTING</b>	<b>PSB-100W-24VDC-RGB-IW</b>	N/A	N/A	N/A
<b>DIMMING &amp; CONTROLS</b>				
<b>TOUCH SCREEN CONTROLLER (CTP)</b>	•	•	•	•
<b>COLOR DIAL CONTROLLER (CDP)</b>	•	•	•	•
<b>DMX 1 ZONE RGBW TOUCH CONTROLLER (CDMX1-RGBW)</b>	•	•	•	•

## RECOMMENDED CONTROLLERS

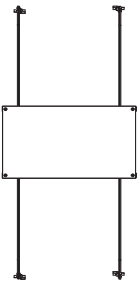

### T-BAR MOUNTING KIT

Includes power supply, box cover, and T-bar hangers for installing Junction Box above ceiling with in easy reach. Comes with 4' of 14 gauge pair Teflon cables with quick secure connectors.

**ORDERING CODES:** PSB-100W-24VDC-RGB-TB  
PSB-2X100W-24VDC-RGB-TB  
PSB-3X100W-24VDC-RGB-TB  
PSB-4X100W-24VDC-RGB-TB

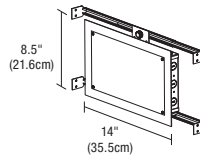

### 8.5" X 14" IN-WALL MOUNTING KIT

Includes Power Supply, Box Cover, and Stud Hangers for installing Junction Box in wall. Use ordering code in the In-Wall Mounting row of the specification table if an In-Wall Mounting Kit is needed.

**ORDERING CODES:** PSB-100W-24VDC-RGB-IW

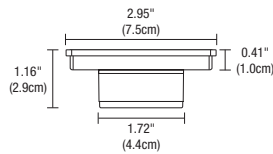
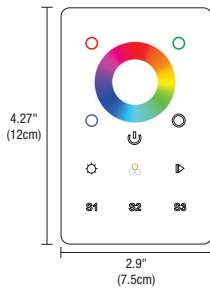
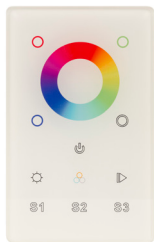

### DESCRIPTION

Full touch controller offers fast and accurate color tone adjustment and independent brightness control. The 1 zone controller can adjust RGBW LEDs smoothly and accurately. Independent smooth dimming of each channel enables the controller to achieve millions of colors. For indoor applications only, and includes a Power Adapter to operate the controller.

### APPLICATIONS

Indoor

### POWER INPUT

120-277VAC

### INSTALLATION

Fits in a single gang 2.5 inch deep junction box, not to be used with a multi gang box

### OUTPUT SIGNAL

USITT DMX 512 (1990)

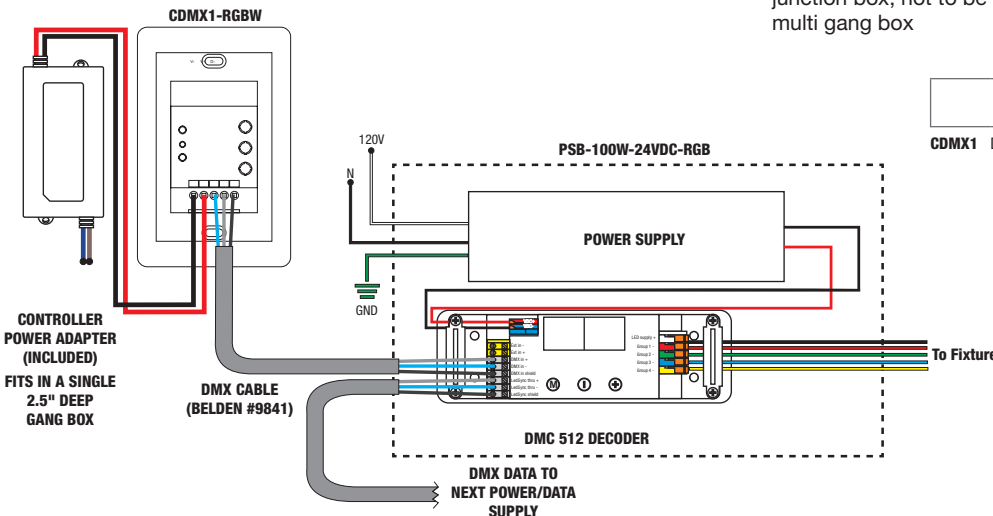

Product	Type	Finish
<b>CDMX1</b>	<b>RGBW</b>	<b>WH</b>
CDMX1 DMX 1 Zone Touch Controller	RGBW Red, Green, Blue and White	WH White

PROJECT	FIXTURE TYPE	DATE



**CTP**

**COLOR TOUCH SCREEN CONTROLLER WITH POWER ADAPTER**



REV 08.02.21

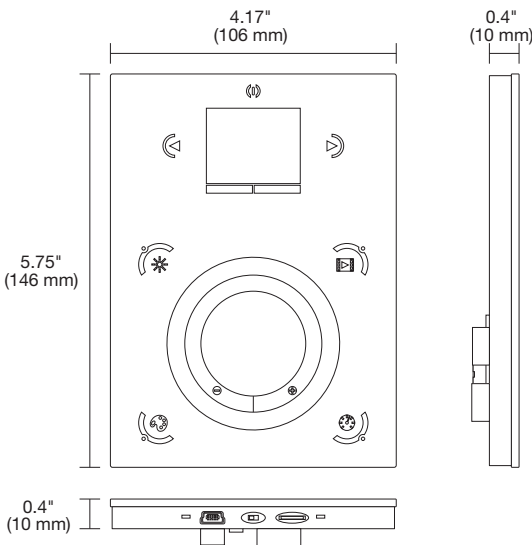
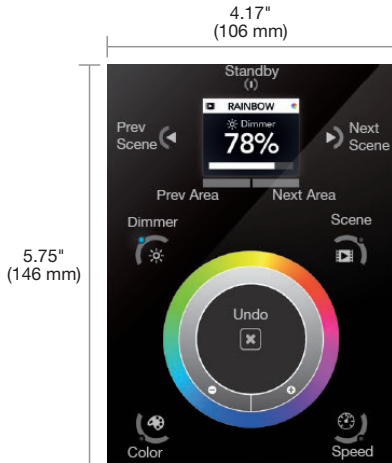

**DESCRIPTION**

Full touch controller offers fast and accurate color tone adjustment and independent brightness control. The 10 zone controller can adjust RGB and RGBW LEDs smoothly and accurately. Independent smooth dimming of each channel enables the controller to achieve millions of colors. For indoor applications only, and includes a Power Adapter to operate the controller.

**FEATURES AND BENEFITS**

**KEY FEATURES:**

- Sleek glass design which sits 11mm from the wall
- Graphical color display to show selected environment
- Color/dimmer/speed palette
- Color temperature mixing
- Touch sensitive buttons. No mechanical parts
- Touch sensitive wheel allows for accurate color selection
- Multi-zone microSD memory
- Multi-room control with 500 scenes, 10 zones
- 1024 DMX channels. Control 340 RGB fixtures
- USB & Ethernet connectivity for programming and control
- RS232, Dry Contact Ports and an Infra Red input port
- Clock and calendar with Sunrise/Sunset triggering
- Network communication. Control lighting remotely
- Catalog of designs including black and white glass
- OEM customization of the color palette and logo
- Windows/Mac software to set dynamic colors/effects
- iPhone/iPad/Android remote and programming apps

**APPLICATIONS**

Indoor

**POWER ADAPTER**

9VDC 0.65A (included)

**POWER INPUT**

7VDC 0.6A

**OUTPUT SIGNAL**

DMX512 1,024 channels total

**INPUT SIGNAL**

Universal IR receiver (Sold Separately), RS232, Contact Closure, Live Computer Link, DMX512, WiFi

**CONNECTIONS**

USB, Ethernet, RS232, Clock, 8 dry contact ports, open drain output

**MEMORY**

microSD (32GB Max)

**COMPUTER AND MOBILE DEVICE REQUIREMENTS**

**IPHONE/IPAD/ANDROID:**

The controller may be used with any of the following apps: DMX Lightpad 3, Easy Remote and Arcolis may be downloaded from App Store or Google Play.

**ESA PRO SOFTWARE (WINDOWS ONLY, TIMELINE AND MULTI-ZONE):**

Windows ME, XP, Vista, 7 or 8 (32 bits and US 2.0, computer connection required for initial setup only.)

**ESA2 SOFTWARE (WINDOWS/MAC, SINGLE ZONE):**

Windows ME, XP, Vista, 7 or 8

Mac OS X 10.7 (Lion), 10.8 (Mountain lion), 10.9 (Mavericks), 10.10 (Yosemite)

Product	Finish
<b>CTP</b>	<b>BK</b>
CTP Color Touch Screen Controller with Power Adapter	BK Black WH White

PROJECT		FIXTURE TYPE		DATE	
---------	--	--------------	--	------	--



CTP

COLOR TOUCH SCREEN CONTROLLER WITH POWER ADAPTER

### RGB Wiring Diagram

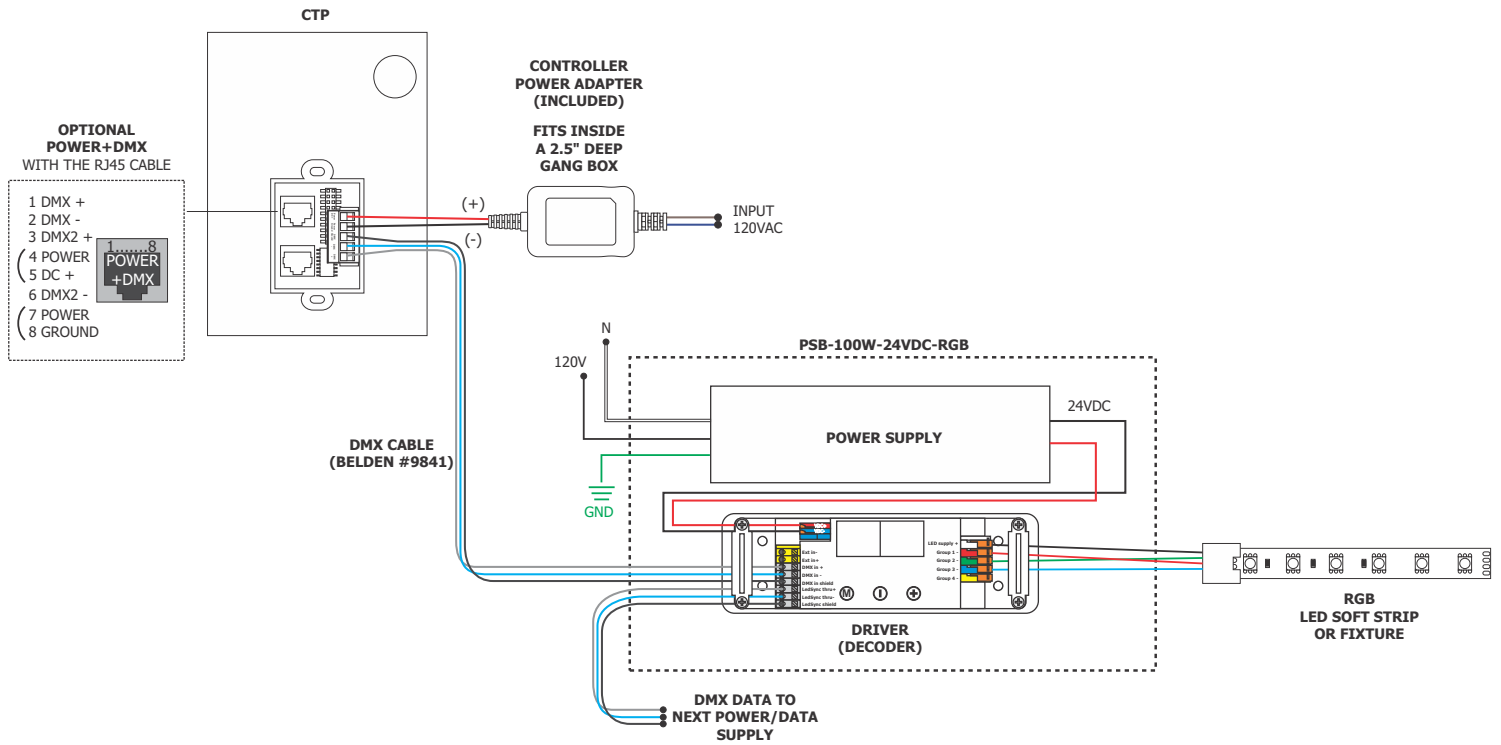

### RGBW Wiring Diagram

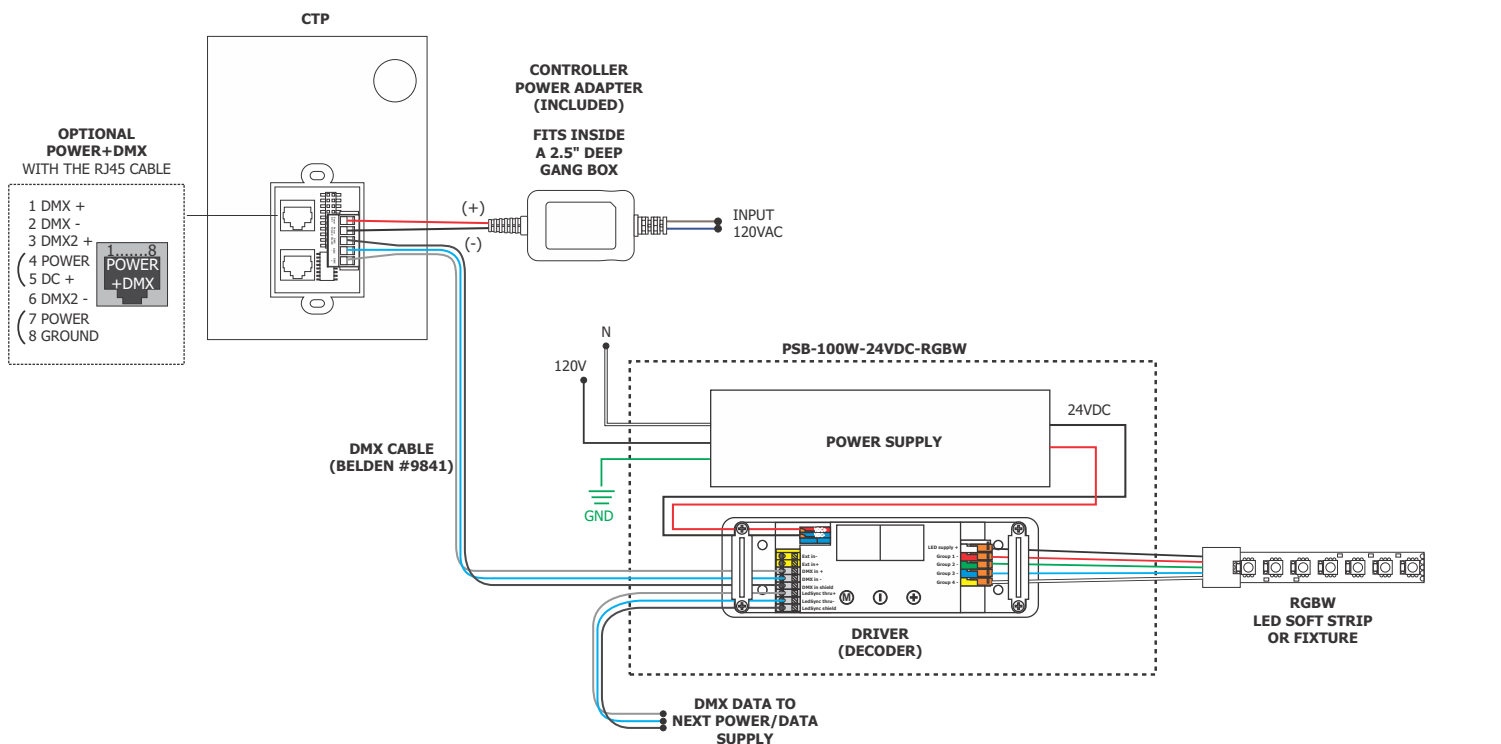

PROJECT		FIXTURE TYPE		DATE	
---------	--	--------------	--	------	--

# LED STRIP TM30 DATA

24VDC, STATIC WHITE, WARM DIM & TUNABLE WHITE

**TM-30-15 DATA:** The data below is for ST2A, ST5A and ST7A bare LED Stomp Strips. Consistent color temperatures throughout a single strip and among multiple strips is possible through a 3 phase binning process in which each order is inspected with a color meter to ensure uniformity.

**2200K** | Rf: 90.5 | Rg: 99.9

Color Vector Graphic

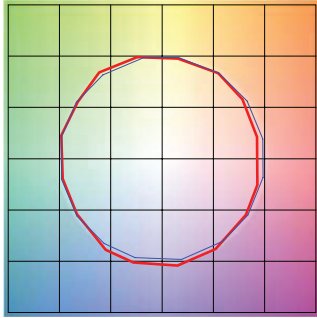

■ Test ■ Reference

GRAPHIC SHIFTS %			
HUE BIN	Rf	CHROMA	HUE
1	88.3	-5.2%	1.0%
2	90.1	-3.6%	3.7%
3	87.5	-0.5%	5.6%
4	93.9	-1.2%	1.3%
5	94.7	0.7%	2.1%
6	93.7	2.6%	0.7%
7	93.5	-1.5%	-2.2%
8	97.8	-0.4%	-0.2%
9	93.7	-1.5%	2.4%
10	90.8	-0.8%	4.9%
11	89.3	3.7%	5.4%
12	90.2	4.6%	1.0%
13	89.0	4.4%	-9.7%
14	75.4	0.6%	-15.1%
15	90.7	-1.7%	-5.0%
16	84.2	-4.4%	-9.1%

**2400K** | Rf: 90.2 | Rg: 99.3

Color Vector Graphic

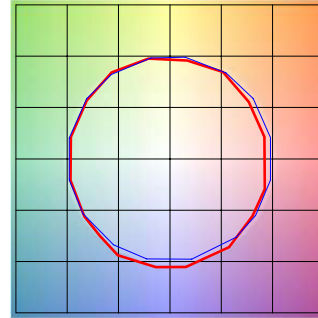

■ Test ■ Reference

GRAPHIC SHIFTS %			
HUE BIN	Rf	CHROMA	HUE
1	89.0	-4.8%	1.1%
2	90.4	-3.7%	3.2%
3	88.1	-0.7%	5.2%
4	93.0	-2.1%	0.9%
5	94.5	-0.1%	2.0%
6	94.7	1.7%	0.6%
7	93.7	-1.9%	-1.5%
8	96.8	-1.2%	0.2%
9	91.9	-1.8%	3.7%
10	88.8	-0.9%	6.1%
11	87.5	3.8%	7.1%
12	89.6	4.3%	0.3%
13	88.1	4.2%	-9.1%
14	82.5	2.8%	-10.6%
15	91.4	-2.1%	-4.2%
16	84.0	-3.6%	-9.9%

**2700K** | Rf: 89.5 | Rg: 98.3

Color Vector Graphic

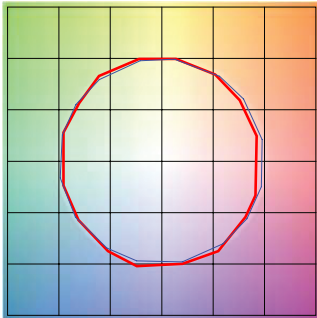

■ Test ■ Reference

GRAPHIC SHIFTS %			
HUE BIN	Rf	CHROMA	HUE
1	88.6	-5.2%	0.9%
2	90.3	-3.6%	2.9%
3	88.4	-1.5%	5.0%
4	91.9	-2.5%	1.4%
5	93.5	-0.9%	2.3%
6	95.7	0.9%	-0.4%
7	91.1	-3.7%	-0.5%
8	95.8	-2.0%	0.4%
9	90.5	-2.6%	4.5%
10	84.9	-1.1%	8.7%
11	85.0	2.3%	9.8%
12	88.1	5.5%	1.5%
13	90.9	2.9%	-5.2%
14	86.2	4.3%	-8.9%
15	90.7	-2.4%	-3.6%
16	83.0	-2.7%	-11.3%

**3000K** | Rf: 88.7 | Rg: 98.2

Color Vector Graphic

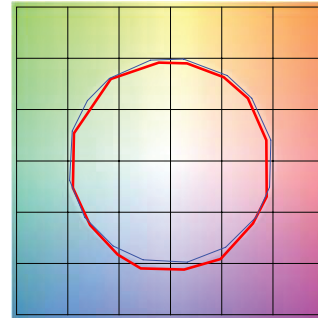

■ Test ■ Reference

GRAPHIC SHIFTS %			
HUE BIN	Rf	CHROMA	HUE
1	88.3	-5.2%	0.8%
2	90.2	-3.7%	2.7%
3	88.3	-1.6%	4.9%
4	92.2	-2.0%	1.8%
5	91.0	-3.5%	1.8%
6	95.8	0.4%	-0.4%
7	90.2	-4.4%	-0.0%
8	94.8	-2.6%	0.8%
9	89.2	-2.9%	6.0%
10	81.4	-1.5%	9.7%
11	82.9	2.3%	10.5%
12	88.3	6.7%	1.9%
13	91.9	2.8%	-4.0%
14	86.3	4.9%	-8.3%
15	87.1	-1.2%	-6.1%
16	83.2	-1.7%	-11.6%

**3500K** | Rf: 88.1 | Rg: 97.1

Color Vector Graphic

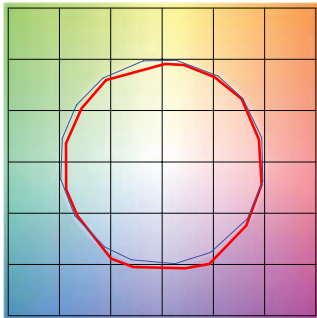

■ Test ■ Reference

GRAPHIC SHIFTS %			
HUE BIN	Rf	CHROMA	HUE
1	87.8	-5.2%	1.0%
2	90.8	-3.3%	2.3%
3	89.8	-1.6%	3.9%
4	91.0	-2.7%	0.9%
5	90.0	-5.4%	0.7%
6	95.6	-0.9%	-0.4%
7	90.0	-5.3%	1.4%
8	91.8	-3.6%	3.0%
9	87.1	-2.9%	7.3%
10	80.1	-1.3%	12.2%
11	81.8	4.1%	10.5%
12	88.2	5.1%	2.3%
13	92.4	2.1%	-3.8%
14	86.6	5.0%	-7.9%
15	86.2	-0.7%	-6.8%
16	84.5	-2.1%	-7.0%

**4000K** | Rf: 87.6 | Rg: 96.8

Color Vector Graphic

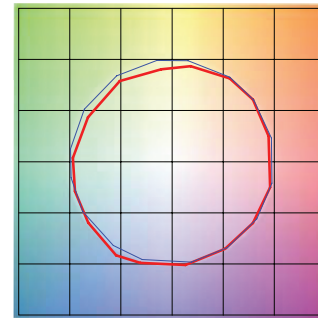

■ Test ■ Reference

GRAPHIC SHIFTS %			
HUE BIN	Rf	CHROMA	HUE
1	88.9	-2.4%	2.5%
2	93.3	-0.4%	0.8%
3	94.8	-1.0%	-0.6%
4	87.9	-4.9%	-3.6%
5	85.3	-9.4%	-2.6%
6	90.2	-6.0%	0.2%
7	85.3	-7.6%	4.6%
8	83.7	-4.1%	8.2%
9	79.5	-1.1%	13.8%
10	78.6	1.5%	12.1%
11	83.5	6.4%	7.8%
12	90.9	3.6%	-1.1%
13	88.3	1.7%	-6.3%
14	91.9	-0.4%	-2.2%
15	84.5	-0.9%	-5.5%
16	84.7	-1.1%	-4.4%

PROJECT	FIXTURE TYPE	DATE
---------	--------------	------

# LED STRIP TM30 DATA

24VDC, STATIC WHITE, WARM DIM & TUNABLE WHITE

**TM-30-15 DATA:** The data below is for ST2A, ST5A and ST7A bare LED Stomp Strips. Consistent color temperatures throughout a single strip and among multiple strips is possible through a 3 phase binning process in which each order is inspected with a color meter to ensure uniformity.

**5700K** | Rf: 87.6 | Rg: 98.0

Color Vector Graphic

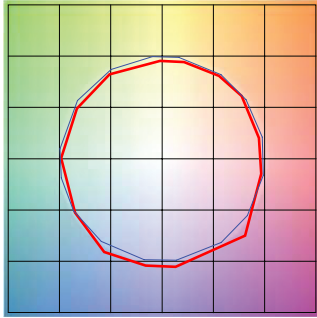

■ Test ■ Reference

HUE BIN	Rf	GRAPHIC SHIFTS %	
		CHROMA	HUE
1	87.9	-3.9%	1.5%
2	92.3	-1.7%	2.7%
3	91.0	-1.2%	2.4%
4	91.5	-1.2%	1.6%
5	86.2	-5.9%	-0.4%
6	93.5	-3.2%	-0.2%
7	93.1	-3.8%	0.6%
8	85.9	-4.6%	5.9%
9	83.6	-4.0%	12.7%
10	75.8	-0.6%	13.6%
11	80.2	4.3%	10.4%
12	83.4	3.4%	1.8%
13	90.8	5.0%	-2.0%
14	91.8	1.3%	-3.3%
15	79.4	8.6%	-12.7%
16	93.4	-2.7%	-0.2%

**2700D** | Rf: 90.7 | Rg: 101.1

Color Vector Graphic

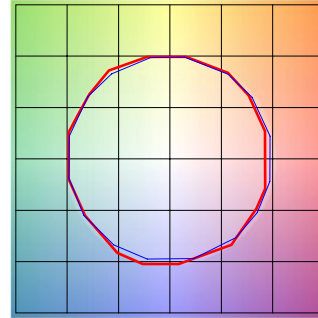

■ Test ■ Reference

HUE BIN	Rf	GRAPHIC SHIFTS %	
		CHROMA	HUE
1	90.9	-4.1%	1.1%
2	91.8	-2.2%	3.2%
3	89.0	0.2%	5.0%
4	92.9	-1.1%	0.8%
5	93.9	1.1%	1.7%
6	93.3	3.3%	0.0%
7	93.1	-0.5%	-1.9%
8	97.2	-0.3%	-0.9%
9	93.4	-1.0%	3.2%
10	89.9	-0.1%	5.6%
11	87.0	4.7%	7.2%
12	89.2	5.8%	-0.2%
13	89.1	3.5%	-6.7%
14	86.3	4.1%	-9.2%
15	91.4	-2.0%	-3.6%
16	84.7	-2.1%	-10.3%

**3000D** | Rf: 90.6 | Rg: 101.1

Color Vector Graphic

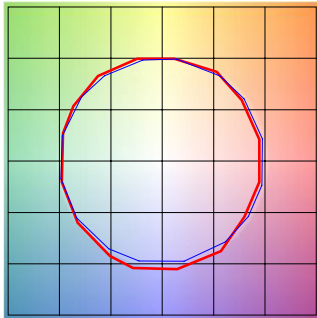

■ Test ■ Reference

HUE BIN	Rf	GRAPHIC SHIFTS %	
		CHROMA	HUE
1	91.5	-3.5%	1.3%
2	92.2	-1.8%	3.0%
3	89.3	0.5%	4.8%
4	92.7	-1.1%	0.6%
5	93.3	0.5%	1.4%
6	93.8	2.7%	-0.8%
7	91.2	-2.1%	-0.2%
8	97.0	-0.5%	-0.7%
9	92.5	-0.7%	3.8%
10	88.3	0.9%	7.1%
11	87.5	3.9%	7.6%
12	88.2	6.2%	-0.2%
13	89.9	3.4%	-6.0%
14	86.9	4.4%	-8.5%
15	91.9	-1.9%	-2.9%
16	84.7	-1.3%	-10.6%

**2000K ONLY (2K4K)** | Rf: 90.6 | Rg: 98.5

Color Vector Graphic

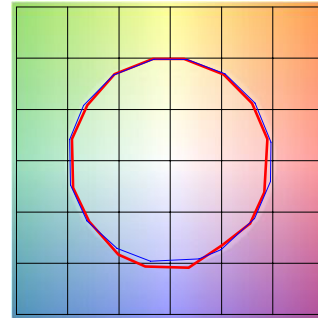

■ Test ■ Reference

HUE BIN	Rf	GRAPHIC SHIFTS %	
		CHROMA	HUE
1	87.7	-5.5%	1.2%
2	88.7	-3.9%	4.2%
3	90.5	-1.5%	4.3%
4	95.0	-1.7%	0.8%
5	95.2	-0.2%	2.1%
6	94.2	1.6%	1.9%
7	95.9	-0.8%	-2.2%
8	95.5	-1.7%	1.3%
9	93.8	-1.4	2.6%
10	91.9	-0.7%	4.2%
11	91.3	3.6%	3.7%
12	91.2	4.2%	-1.0%
13	86.6	3.8%	-12.7%
14	67.2	-3.0%	-16.3%
15	84.9	-3.3%	-9.4%
16	84.2	-5.7%	-7.5%

**3000K (2K4K)** | Rf: 90.5 | Rg: 100.7

Color Vector Graphic

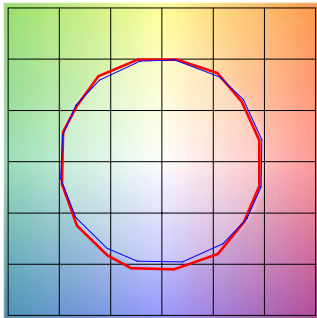

■ Test ■ Reference

HUE BIN	Rf	GRAPHIC SHIFTS %	
		CHROMA	HUE
1	91.5	-3.5%	1.2%
2	92.4	-1.8%	2.7%
3	89.8	0.3%	4.5%
4	92.4	-1.7%	0.4%
5	93.3	-0.1%	1.4%
6	94.5	2.1%	-0.6%
7	91.0	-2.5%	0.3%
8	96.9	-0.8%	-0.2%
9	91.6	-0.9%	4.6%
10	86.7	0.7%	7.8%
11	86.3	3.8%	8.5%
12	88.3	6.1%	0.6%
13	90.9	3.1%	-5.2%
14	87.3	4.7%	-7.9%
15	92.1	-1.9%	-2.5%
16	84.5	-0.9%	-10.9%

**4000K ONLY (2K4K)** | Rf: 86.4 | Rg: 96.1

Color Vector Graphic

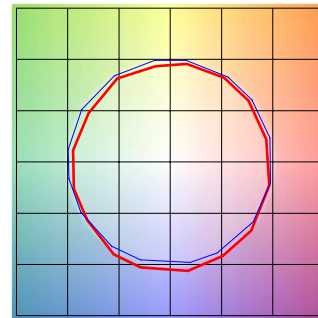

■ Test ■ Reference

HUE BIN	Rf	GRAPHIC SHIFTS %	
		CHROMA	HUE
1	86.5	-5.5%	1.3%
2	90.4	-3.0%	2.3%
3	89.8	-2.1%	3.6%
4	89.1	-3.4%	0.4%
5	88.5	-5.9%	0.1%
6	93.6	-3.0%	-0.4%
7	88.9	-6.2%	1.7%
8	87.3	-5.0%	4.9%
9	82.4	-3.6%	11.3%
10	77.4	-1.8%	12.7%
11	79.8	4.9%	11.4%
12	88.7	4.4%	2.7%
13	88.7	4.0%	-5.1%
14	91.2	2.2%	-3.8%
15	82.7	-0.1%	-9.2%
16	82.8	-2.2%	-7.6%

PROJECT	FIXTURE TYPE	DATE
---------	--------------	------

# LED STRIP TM30 DATA

24VDC, STATIC WHITE, WARM DIM & TUNABLE WHITE

**TM-30-15 DATA:** The data below is for ST2A, ST5A and ST7A bare LED Stomp Strips. Consistent color temperatures throughout a single strip and among multiple strips is possible through a 3 phase binning process in which each order is inspected with a color meter to ensure uniformity.

**6500K ONLY (27K6)** | Rf: 86.8 | Rg: 96.8

Color Vector Graphic

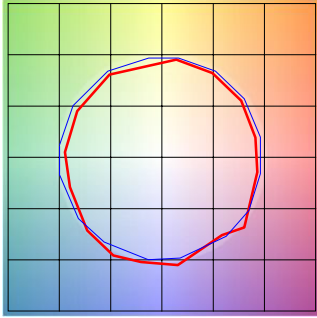

■ Test ■ Reference

HUE BIN	Rf	GRAPHIC SHIFTS %	
		CHROMA	HUE
1	86.5	-4.7%	0.8%
2	91.9	-2.5%	3.1%
3	91.2	-2.0%	1.9%
4	91.2	-1.6%	1.4%
5	85.7	-6.2%	-0.9%
6	92.9	-3.5%	-1.0%
7	92.1	-4.7%	0.7%
8	85.2	-5.8%	4.9%
9	82.8	-6.2%	14.3%
10	77.1	-0.7%	15%
11	72.1	5.8%	14.1%
12	91.6	4.0%	1.0%
13	89.9	5.6%	-2.3%
14	90.5	-1.8%	-3.7%
15	81.6	6.5%	-13.9%
16	92.8	-3.6%	-0.4%

PROJECT	FIXTURE TYPE	DATE
---------	--------------	------

# LED STRIP TM30 DATA

24VDC, HIGH OUTPUT, STATIC WHITE, WARM DIM, RGB, RGB+W & TUNABLE WHITE

**TM-30-15 DATA:** The data below is for PL2C, PL5C and PL7C bare LED Soft Strips. Consistent color temperatures throughout a single strip and among multiple strips is possible through a 3 phase binning process in which each order is inspected with a color meter to ensure uniformity.

**2200K** | Rf: 83.9 | Rg: 94.9

Color Vector Graphic

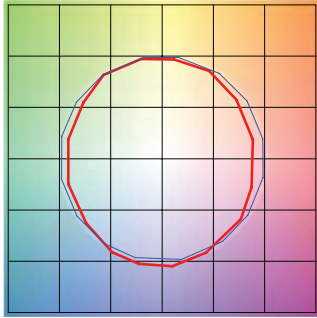

■ Test ■ Reference

GRAPHIC SHIFTS %			
HUE BIN	Rf	CHROMA	HUE
1	78.8	-9.5%	1.3%
2	80.7	-7.8%	6.7%
3	78.2	-3.3%	9.4%
4	89.7	-2.8%	3.6%
5	93.2	-0.8%	2.6%
6	93.0	-0.6%	-0.7%
7	87.7	-5.9%	-3.5%
8	89.2	-6.8%	1.9%
9	83.4	-5.6%	6.0%
10	79.3	-3.7%	10.8%
11	81.4	2.9%	11.1%
12	84.9	5.3%	4.9%
13	88.1	4.9%	-10.1%
14	68.1	0.1%	-19.5%
15	86.0	-3.3%	-7.3%
16	76.4	-8.9%	-11.7%

**2400K** | Rf: 84.5 | Rg: 94.4

Color Vector Graphic

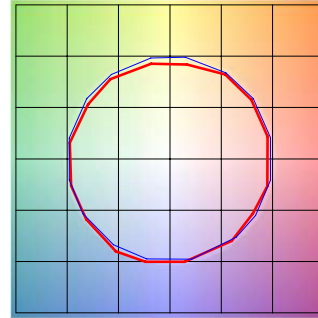

■ Test ■ Reference

GRAPHIC SHIFTS %			
HUE BIN	Rf	CHROMA	HUE
1	92	-2.4%	1.5%
2	94.7	-2.1%	-0.0%
3	95.4	-1.9%	-0.1%
4	88.7	-6.7%	-3.1%
5	92.8	-5.6%	1.0%
6	92.7	-3.4%	3.4%
7	89.9	-4.3%	4.1%
8	92.4	-1.4%	4.4%
9	89	-0.6%	5.8%
10	88.9	0.4%	6.2%
11	89.7	4.0%	5.4%
12	92.6	3.0%	-0.7%
13	90.9	1.1%	-7.0%
14	89.9	0.5%	-5.8%
15	92.1	-3.2%	0.1%
16	88.9	-1.7%	-6.3%

**2700K** | Rf: 87.7 | Rg: 96.1

Color Vector Graphic

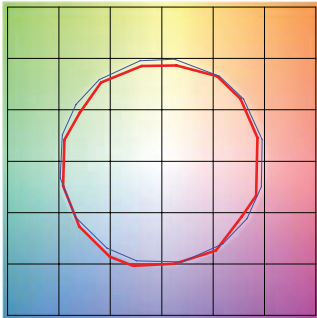

■ Test ■ Reference

GRAPHIC SHIFTS %			
HUE BIN	Rf	CHROMA	HUE
1	88.0	-4.3%	2.6%
2	91.6	-2.4%	2.0%
3	93.7	-1.4%	1.9%
4	88.9	-5.6%	-3.1%
5	92.3	-5.5%	-0.5%
6	92.9	-3.5%	0.1%
7	84.5	-7.5%	4.6%
8	90.8	-3.0%	4.4%
9	84.5	-1.3%	8.3%
10	83.9	2.0%	9.8%
11	87.2	5.3%	7.1%
12	89.2	5.4%	-2.6%
13	88.7	0.3%	-7.8%
14	86.8	1.7%	-9.3%
15	87.6	-5.4%	-1.3%
16	83.6	-3.3%	-9.5%

**3000K** | Rf: 88.1 | Rg: 99.7

Color Vector Graphic

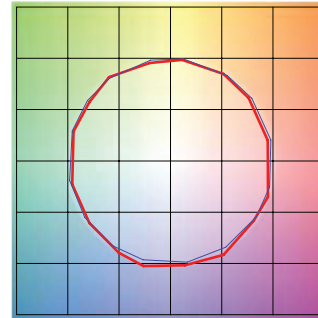

■ Test ■ Reference

GRAPHIC SHIFTS %			
HUE BIN	Rf	CHROMA	HUE
1	92.5	-3.1%	0.3%
2	93.3	-2.3%	1.9%
3	90.9	-0.8%	3.9%
4	94.3	-1.1%	1.4%
5	92.5	-2.6%	1.5%
6	96.4	1.2%	-0.3%
7	92.6	-2.5%	-0.0%
8	96.9	-1.4%	0.2%
9	92.3	-1.8%	4.3%
10	86.6	-0.7%	7.0%
11	86.5	2.4%	8.2%
12	89.8	5.9%	1.7%
13	93.9	2.6%	-2.7%
14	89.4	5.1%	-5.8%
15	90.1	-0.1%	-4.7%
16	86.5	0.3%	-9.7%

**3500K** | Rf: 86.1 | Rg: 95.5

Color Vector Graphic

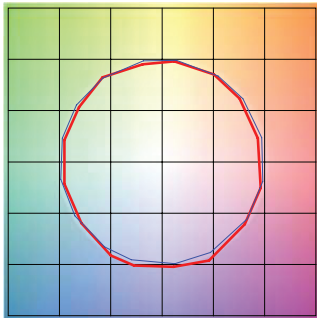

■ Test ■ Reference

GRAPHIC SHIFTS %			
HUE BIN	Rf	CHROMA	HUE
1	90.8	-3.8%	0.3%
2	92.3	-2.8%	2.1%
3	89.7	-1.0%	4.3%
4	92.6	-1.4%	1.7%
5	91.8	-3.1%	1.3%
6	96.2	0.8%	-0.4%
7	92.9	-3.2%	0.2%
8	94.3	-2.5%	1.5%
9	90.4	-2.5%	5.2%
10	84.3	-1.4%	9.5%
11	83.1	3.5%	9.8%
12	88.2	4.8%	3.4%
13	94.0	2.7%	-2.0%
14	88.7	5.9%	-5.8%
15	88.7	0.7%	-5.9%
16	86.8	-0.7%	-6.7%

**4000K** | Rf: 87.6 | Rg: 96.8

Color Vector Graphic

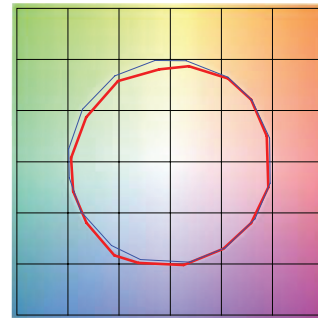

■ Test ■ Reference

GRAPHIC SHIFTS %			
HUE BIN	Rf	CHROMA	HUE
1	88.9	-2.4%	2.5%
2	93.3	-0.4%	0.8%
3	94.8	-1.0%	-0.6%
4	87.9	-4.9%	-3.6%
5	85.3	-9.4%	-2.6%
6	90.2	-6.0%	0.2%
7	85.3	-7.6%	4.6%
8	83.7	-4.1%	8.2%
9	79.5	-1.1%	13.8%
10	78.6	1.5%	12.1%
11	83.5	6.4%	7.8%
12	90.9	3.6%	-1.1%
13	88.3	1.7%	-6.3%
14	91.9	-0.4%	-2.2%
15	84.5	-0.9%	-5.5%
16	84.7	-1.1%	-4.4%

PROJECT	FIXTURE TYPE	DATE
---------	--------------	------

# LED STRIP TM30 DATA

24VDC, HIGH OUTPUT, STATIC WHITE, WARM DIM, RGB, RGB+W & TUNABLE WHITE

**TM-30-15 DATA:** The data below is for PL2C, PL5C and PL7C bare LED Soft Strips. Consistent color temperatures throughout a single strip and among multiple strips is possible through a 3 phase binning process in which each order is inspected with a color meter to ensure uniformity.

**5700K** | Rf: 80.3 | Rg: 91.5

Color Vector Graphic

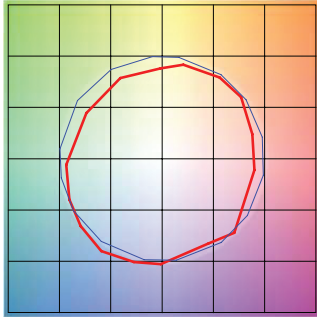

■ Test ■ Reference

HUE BIN	Rf	GRAPHIC SHIFTS %	
		CHROMA	HUE
1	75.4	-8.9%	4.7%
2	87.5	-2.6%	4.6%
3	90.7	-3.0%	-0.5%
4	83.2	-6.0%	-5.7%
5	76.2	-12.9%	-5.3%
6	81.4	-11.9%	-2.6%
7	74.8	-14.0%	5.1%
8	69.0	-9.0%	14.1%
9	72.6	-3.6%	22.2%
10	71.4	2.7%	16.1%
11	81.3	7.9%	5.3%
12	83.6	4.1%	-9.4%
13	78.4	0.7%	-15.3%
14	77.7	-6.2%	-11.0%
15	68.8	-1.3%	-21.2%
16	80.8	-9.6%	3.3%

**2700D** | Rf: 89.5 | Rg: 100.8

Color Vector Graphic

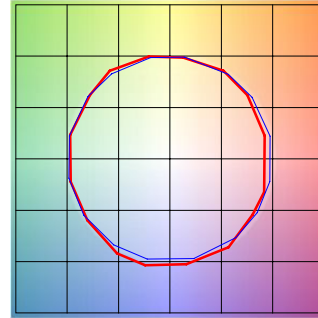

■ Test ■ Reference

HUE BIN	Rf	GRAPHIC SHIFTS %	
		CHROMA	HUE
1	88.8	-5.1%	1.4%
2	89.8	-2.7%	4.1%
3	87.2	0.3%	5.9%
4	92.3	-0.9%	1.0%
5	93.3	1.5%	1.7%
6	92.4	3.6%	-0.2%
7	92.2	-0.9%	-2.4%
8	96.7	-0.4%	-1.1%
9	92.3	-1.2%	3.7%
10	88.9	-0.0%	6.1%
11	86.4	5.1%	7.4%
12	88.2	6.3%	-0.9%
13	87.2	3.8%	-8.1%
14	84.2	3.8%	-11.0%
15	89.8	-2.6%	-4.3%
16	82.7	-3.4%	-11.1%

**3000D** | Rf: 89.8 | Rg: 101.4

Color Vector Graphic

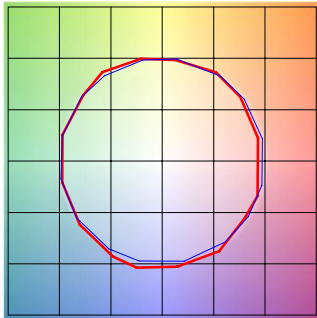

■ Test ■ Reference

HUE BIN	Rf	GRAPHIC SHIFTS %	
		CHROMA	HUE
1	90.2	-4.2%	1.5%
2	90.9	-2.0%	3.7%
3	87.9	0.8%	5.5%
4	92.1	-0.9%	0.6%
5	93.0	1.5%	1.6%
6	92.2	3.9%	-0.2%
7	92.1	-0.3%	-2.0%
8	96.7	0.0%	-1.2%
9	92.5	-0.6%	3.7%
10	88.3	1.1%	7.0%
11	87.2	4.1%	7.4%
12	87.2	6.7%	-1.0%
13	88.2	3.8%	-7.2%
14	85.3	4.3%	-9.9%
15	90.9	-2.2%	-3.6%
16	83.4	-2.2%	-11.2%

**2000K ONLY (2K6K/27K6)** | Rf: 84.3 | Rg: 96.9

Color Vector Graphic

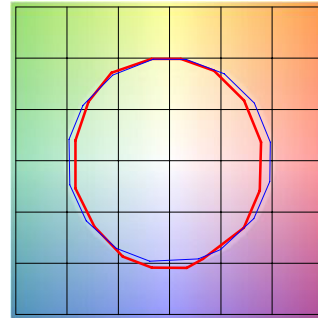

■ Test ■ Reference

HUE BIN	Rf	GRAPHIC SHIFTS %	
		CHROMA	HUE
1	80.3	-8.9%	1.7%
2	79.7	-7.0%	7.8%
3	78.9	-2.9%	10.0%
4	89.5	-0.5%	5.1%
5	94.4	0.7%	1.7%
6	92.1	2.4%	-0.3%
7	89.4	-2.4%	-5.9%
8	89.7	-6.4%	-0.2%
9	86.0	-4.9%	4.6%
10	81.8	-3.4%	9.3%
11	83.1	3.3%	9.7%
12	85.8	5.6%	3.3%
13	85.6	6.2%	-12.8%
14	61.7	-1.9%	-19.0%
15	79.7	-3.3%	-12.9%
16	78.1	-7.9%	-10.6%

**3000K (2K6K/27K6)** | Rf: 90.2 | Rg: 101.4

Color Vector Graphic

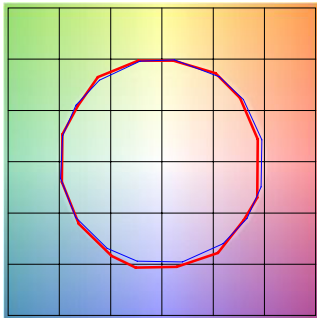

■ Test ■ Reference

HUE BIN	Rf	GRAPHIC SHIFTS %	
		CHROMA	HUE
1	90.9	-3.8%	1.3%
2	91.7	-1.9%	3.3%
3	88.7	0.7%	5.1%
4	92.4	-1.0%	0.7%
5	92.9	0.9%	1.7%
6	93.1	3.3%	-0.6%
7	91.0	-1.8%	-0.4%
8	97.0	0.2%	-1.1%
9	92.8	-0.5%	3.6%
10	88.3	1.0%	7.0%
11	87.1	3.8%	7.8%
12	87.6	6.5%	-0.3%
13	89.3	3.6%	-6.3%
14	86.1	4.5%	-9.1%
15	91.6	-1.9%	-3.1%
16	83.8	-1.5%	-11.2%

**4000K ONLY (2K6K/27K6)** | Rf: 89.6 | Rg: 99.1

Color Vector Graphic

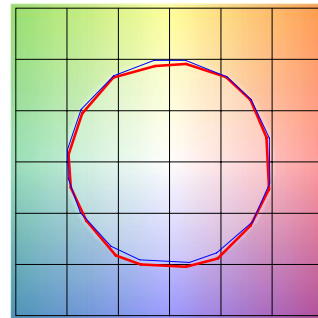

■ Test ■ Reference

HUE BIN	Rf	GRAPHIC SHIFTS %	
		CHROMA	HUE
1	91.3	-2.5%	1.0%
2	95.3	-0.5%	0.5%
3	94.3	-0.7%	1.1%
4	91.1	-3.4%	-1.1%
5	89.5	-5.6%	0.0%
6	94.6	-1.4%	1.3%
7	93.2	-3.0%	2.6%
8	91.3	-1.8%	4.6%
9	86.5	-0.9%	9.1%
10	83.3	-0.5%	9.5%
11	83.3	4.9%	9.0%
12	89.7	4.1%	1.7%
13	90.1	3.6%	-4.3%
14	93.4	5.2%	-2.1%
15	87.4	0.4%	-4.3%
16	86.6	0.4%	-6.1%

PROJECT	FIXTURE TYPE	DATE
---------	--------------	------



# LED STRIP TM30 DATA

24VDC, HIGH OUTPUT, STATIC WHITE, WARM DIM, RGB, RGB+W & TUNABLE WHITE

**TM-30-15 DATA:** The data below is for PL2C, PL5C and PL7C bare LED Soft Strips. Consistent color temperatures throughout a single strip and among multiple strips is possible through a 3 phase binning process in which each order is inspected with a color meter to ensure uniformity.

**6500K ONLY (2K6K/27K6) | Rf: 86.8 | Rg: 96.8**

Color Vector Graphic

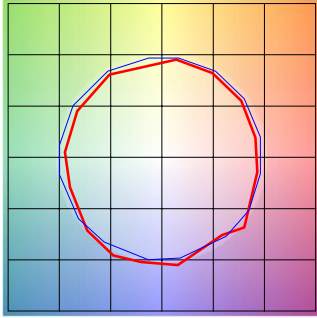

■ Test ■ Reference

HUE BIN	Rf	GRAPHIC SHIFTS %	
		CHROMA	HUE
1	86.5	-4.7%	0.8%
2	91.9	-2.5%	3.1%
3	91.2	-2.0%	1.9%
4	91.2	-1.6%	1.4%
5	85.7	-6.2%	-0.9%
6	92.9	-3.5%	-1.0%
7	92.1	-4.7%	0.7%
8	85.2	-5.8%	4.9%
9	82.8	-6.2%	14.3%
10	77.1	-0.7%	15%
11	72.1	5.8%	14.1%
12	91.6	4.0%	1.0%
13	89.9	5.6%	-2.3%
14	90.5	-1.8%	-3.7%
15	81.6	6.5%	-13.9%
16	92.8	-3.6%	-0.4%

PROJECT		FIXTURE TYPE		DATE	
---------	--	--------------	--	------	--