

ZIP WAVE

LED SUSPENSION DOWNLIGHT WITH REMOTE POWER - END FEED

DESIGNED BY GREGORY KAY | ASSEMBLED IN AMERICA

REV 07.16.20



Five (5) Zip Waves are shown here

DESCRIPTION

Add curves and volume to any space with the Zip Wave Suspension Downlight. This contemporary, curvy, linear LED fixture offers lighting that is crisp and spot-free. It is available in a range of increments from 48" to 240" (20ft), a 100° beam spread, optional adjustable white or black louver, multiple finishes, and a spectrum of color temperatures including Warm Dim. Fixture includes a 5-year pro-rated warranty. For custom designs and quotes, send drawings to design@PureEdgeLighting.com.

INSTALLATION

- Mounts to a standard junction box, pre-wired from either a 120V with a 60 watt NON-IC (50W-IC) power supply that fits in the ceiling electrical junction box, or from a remote power supply feeding 24VDC up to 100 watts at a maximum of 40ft away
- Includes your choice of one or two canopies: one for remote power (under 60 watts NON-IC, fits in Jbox), one blank at end cap - 2R2, 2S2, 4R2, 4S2
- Includes adjustable 12ft coaxial and aircraft cables (additional aircraft cables included for support when fixture exceeds 96")
- Power supplies sold separately

FINISHES



Satin Black **BK** Chrome **CH** Satin Nickel **SN** White **WH**

LENSES

- Available in a 100° white diffused lens
- Optional black or white louver available

LAMPING

- Choose from 9 color temperatures from 2200K-5700K including Warm Dim
- Warm Dim: 2700K to 2000K (**27D**) or 3000K to 2000K (**30D**)
- 50,000 Hour Lamp Life

REMOTE POWER SUPPLIES* & DIMMERS (SOLD SEPARATELY)

- Electronic Low Voltage Dimming (**ELV**): 60 watt (fits in JBox)
- 0-10 Volt Dimming (**0-10V**)
- Lutron Hi-Lume®
- Universal Dimming: Universal Dimming (TRIAC, ELV, 0-10V) with corresponding dimmer

*In-Wall Mounting Kits available for select power supplies

APPLICATIONS

Designed for indoor use only. Ideal application environments include: restaurants, hallways, conference rooms, kitchens, dining rooms, architectural lighting, general lighting, and retail

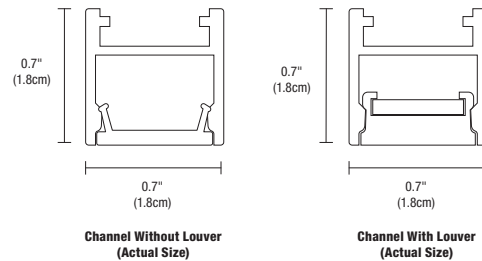

System	Wattage Per Foot	Canopy	Nominal Size (Inches)	Color Temperature	Finish
WSD	5W	2R	240	22K	SN
WSD Zip Wave Suspension Diffused Lens with Remote Power	5W 5 Watt	2R 2.8" Round Canopy	48-240 Order in various increments from 48" to 240" at 5 watts per foot. Maximum shipping length for Chrome is 84"	22K 2200K Candle White	BK Satin Black
WSDW Zip Wave Suspension Diffused Lens with White Louver	7W 7.5 Watt	2S 2.8" Square Canopy		24K 2400K Very Warm White	CH Chrome
WSDB Zip Wave Suspension Diffused Lens with Black Louver		4R 4.6" Round Canopy		27K 2700K Incandescent White	SN Satin Nickel
		4S 4.6" Square Canopy		27D 2700K Warm Dim (5W only)	WH White
		2R2 2x2.8" Round Canopies		30K 3000K Warm White	
		2S2 2x2.8" Square Canopies		30D 3000K Warm Dim (5W only)	
		4R2 2x4.6" Round Canopies		35K 3500K Neutral White	
		4S2 2x4.6" Square Canopies		40K 4000K Cool White	
				57K 5700K Daylight White	

*See length chart on pg 2 for exact dimensions

PROJECT	FIXTURE TYPE	DATE
---------	--------------	------

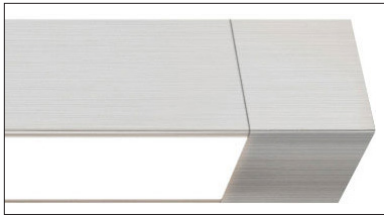

DIFFUSED WHITE LENS

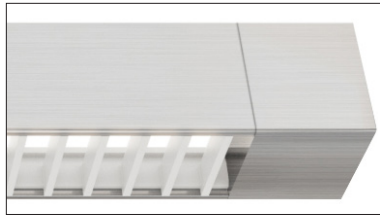

DIFFUSED WHITE LENS WITH WHITE LOUVER

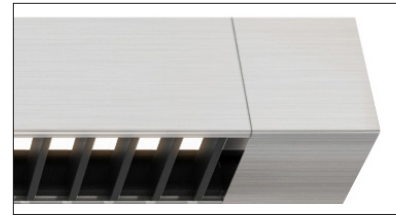

CLEAR FROSTED LENS WITH BLACK LOUVER

Lamp Data: Lamp data for Zip Wave Suspension Downlight with Remote - End Feed

WSD																
DESCRIPTION	100 Degree Diffused White Lens without Lens															
WATTS PER FOOT	5W (4.4 watts)								7W (7.5 watts)							
COLOR TEMPERATURE	22K	24K	27K	27D*	30K	30D*	35K	40K	57K	22K	24K	27K	30K	35K	40K	57K
LUMENS PER FOOT (lm/ft)	209	232	255	260	278	284	319	346	369	343	381	418	457	523	569	606
LUMENS PER WATT (lm/w)	47	53	58	54	63	59	72	79	84	47	52	57	63	72	78	83
CRI	85+	90+	95+	95+	95+	95+	85+	84	84	85+	90+	95+	95+	85+	84	84

*27D & 30D use 7.5 watts per foot.

WSDW																
DESCRIPTION	100 Degree Diffused White Lens with White Louver															
WATTS PER FOOT	5W (4.4 watts)								7W (7.5 watts)							
COLOR TEMPERATURE	22K	24K	27K	27D*	30K	30D*	35K	40K	57K	22K	24K	27K	30K	35K	40K	57K
LUMENS PER FOOT (lm/ft)	130	145	159	162	174	177	199	216	230	214	237	261	285	327	355	378
LUMENS PER WATT (lm/w)	30	33	36	34	39	37	45	49	52	29	33	36	39	45	49	52
CRI	85+	90+	95+	95+	95+	95+	85+	84	84	85+	90+	95+	95+	85+	84	84

*27D & 30D use 7.5 watts per foot.

WSDB																
DESCRIPTION	100 Degree Diffused White Lens with Black Louver															
WATTS PER FOOT	5W (4.4 watts)								7W (7.5 watts)							
COLOR TEMPERATURE	22K	24K	27K	27D*	30K	30D*	35K	40K	57K	22K	24K	27K	30K	35K	40K	57K
LUMENS PER FOOT (lm/ft)	81	90	99	101	108	110	124	134	143	133	148	162	177	203	221	235
LUMENS PER WATT (lm/w)	18	20	22	21	25	23	28	31	33	18	20	22	24	28	30	32
CRI	85+	90+	95+	95+	95+	95+	85+	84	84	85+	90+	95+	95+	85+	84	84

*27D & 30D use 7.5 watts per foot.

5W DIFFUSED WHITE			
Distance	Foot Candles 5W	Beam Width Vert. Spread 101.1°	Beam Width Horiz. Spread 97.4°
1.7ft	120fc	4.1ft	3.9ft
3.3ft	39fc	8.0ft	7.5ft
5.0ft	16fc	12.1ft	11.4ft
6.7ft	10fc	16.3ft	15.3ft
8.3ft	6fc	20.2ft	18.9ft
10.0ft	4fc	24.3ft	22.8ft

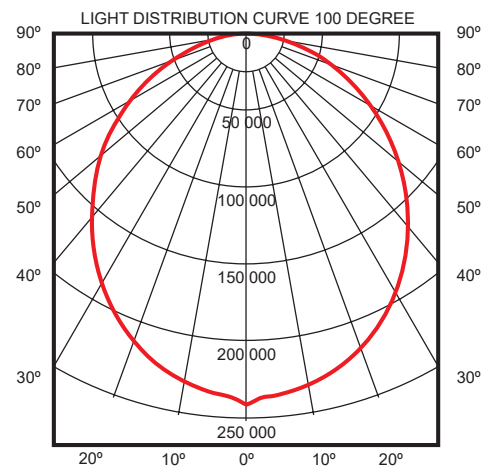

PROJECT	FIXTURE TYPE	DATE
---------	--------------	------



ZIP WAVE

LED SUSPENSION DOWNLIGHT WITH REMOTE POWER - END FEED



REV 07.16.20

Length Chart: Actual lengths for Zip Suspension Downlight - Remote Power Supply

22K, 24K, 27K, 30K, 35K, 40K & 57K									
Ordering Code (Nominal Size)	Actual Length (Inches)	5W (5 Watts)	Power Supply	7W (7.5 Watts)	Power Supply	Ordering Code (Nominal Size)	Actual Length (Inches)	5W (5 Watts)	Power Supply
48	48.6	20	PSB-40W-UNI-24VDC	30	PSB-40W-UNI-24VDC	202	201.4	84	PSB-96W-UNI-24VDC
51	51.0	21	PSB-40W-UNI-24VDC	32	PSB-40W-UNI-24VDC	204	203.8	85	PSB-96W-UNI-24VDC
53	53.4	22	PSB-40W-UNI-24VDC	33	PSB-40W-UNI-24VDC	207	206.2	86	PSB-96W-UNI-24VDC
56	55.8	23	PSB-40W-UNI-24VDC	35	PSB-40W-UNI-24VDC	209	208.6	87	PSB-96W-UNI-24VDC
58	58.1	24	PSB-40W-UNI-24VDC	36	PSB-40W-UNI-24VDC	212	210.9	88	PSB-96W-UNI-24VDC
60	60.5	25	PSB-40W-UNI-24VDC	38	PSB-40W-UNI-24VDC	214	213.3	89	PSB-96W-UNI-24VDC
63	62.9	26	PSB-40W-UNI-24VDC	39	PSB-40W-UNI-24VDC	216	215.7	90	PSB-96W-UNI-24VDC
65	65.3	27	PSB-40W-UNI-24VDC	41	PSB-60W-UNI-24VDC	219	218.1	91	PSB-96W-UNI-24VDC
68	67.7	28	PSB-40W-UNI-24VDC	43	PSB-60W-UNI-24VDC	221	220.5	92	PSB-96W-UNI-24VDC
70	70.1	29	PSB-40W-UNI-24VDC	44	PSB-60W-UNI-24VDC	224	222.9	93	PSB-96W-UNI-24VDC
72	72.5	30	PSB-40W-UNI-24VDC	45	PSB-60W-UNI-24VDC	226	225.3	94	PSB-96W-UNI-24VDC
75	74.9	31	PSB-40W-UNI-24VDC	47	PSB-60W-UNI-24VDC	228	227.7	95	PSB-96W-UNI-24VDC
77	77.2	32	PSB-40W-UNI-24VDC	48	PSB-60W-UNI-24VDC	231	230.0	96	PSB-96W-UNI-24VDC
80	79.6	33	PSB-40W-UNI-24VDC	50	PSB-60W-UNI-24VDC	233	232.4	97	PSB-100W-ELV-24VDC
82	82.0	34	PSB-40W-UNI-24VDC	51	PSB-60W-UNI-24VDC	236	234.8	98	PSB-100W-ELV-24VDC
84*	84.4	35	PSB-40W-UNI-24VDC	53	PSB-60W-UNI-24VDC	238	237.2	99	PSB-100W-ELV-24VDC
87	86.8	36	PSB-40W-UNI-24VDC	54	PSB-60W-UNI-24VDC	240	239.6	100	PSB-100W-ELV-24VDC
89	89.2	37	PSB-40W-UNI-24VDC	56	PSB-60W-UNI-24VDC				
92	91.6	38	PSB-40W-UNI-24VDC	58	PSB-60W-UNI-24VDC				
94	94.0	39	PSB-40W-UNI-24VDC	59	PSB-60W-UNI-24VDC				
96	96.4	40	PSB-60W-UNI-24VDC	60	PSB-96W-UNI-24VDC				
99	98.7	41	PSB-60W-UNI-24VDC	62	PSB-96W-UNI-24VDC				
101	101.1	42	PSB-60W-UNI-24VDC	63	PSB-96W-UNI-24VDC				
104	103.5	43	PSB-60W-UNI-24VDC	65	PSB-96W-UNI-24VDC				
106	105.9	44	PSB-60W-UNI-24VDC	66	PSB-96W-UNI-24VDC				
108	108.3	45	PSB-60W-UNI-24VDC	68	PSB-96W-UNI-24VDC				
111	110.7	46	PSB-60W-UNI-24VDC	69	PSB-96W-UNI-24VDC				
113	113.1	47	PSB-60W-UNI-24VDC	71	PSB-96W-UNI-24VDC				
116	115.4	48	PSB-60W-UNI-24VDC	73	PSB-96W-UNI-24VDC				
118	117.8	49	PSB-60W-UNI-24VDC	74	PSB-96W-UNI-24VDC				
120**	120.2	50	PSB-60W-UNI-24VDC	75	PSB-96W-UNI-24VDC				
123	122.6	51	PSB-60W-UNI-24VDC	77	PSB-96W-UNI-24VDC				
125	125.0	52	PSB-60W-UNI-24VDC	78	PSB-96W-UNI-24VDC				
128	127.4	53	PSB-60W-UNI-24VDC	80	PSB-96W-UNI-24VDC				
130	129.8	54	PSB-60W-UNI-24VDC	81	PSB-96W-UNI-24VDC				
132	132.2	55	PSB-60W-UNI-24VDC	83	PSB-96W-UNI-24VDC				
135	134.5	56	PSB-60W-UNI-24VDC	84	PSB-96W-UNI-24VDC				
137	136.9	57	PSB-60W-UNI-24VDC	86	PSB-96W-UNI-24VDC				
140	139.3	58	PSB-60W-UNI-24VDC	87	PSB-96W-UNI-24VDC				
142	141.7	59	PSB-60W-UNI-24VDC	89	PSB-96W-UNI-24VDC				
144	144.1	60	PSB-96W-UNI-24VDC	90	PSB-96W-UNI-24VDC				
147	146.5	61	PSB-96W-UNI-24VDC	92	PSB-96W-UNI-24VDC				
149	148.9	62	PSB-96W-UNI-24VDC	93	PSB-96W-UNI-24VDC				
152	151.3	63	PSB-96W-UNI-24VDC	95	PSB-96W-UNI-24VDC				
154	153.6	64	PSB-96W-UNI-24VDC	96	PSB-96W-UNI-24VDC				
156	156.0	65	PSB-96W-UNI-24VDC	98	PSB-100W-ELV-24VDC				
159	158.4	66	PSB-96W-UNI-24VDC	99	PSB-100W-ELV-24VDC				
161	160.8	67	PSB-96W-UNI-24VDC						
164	163.2	68	PSB-96W-UNI-24VDC						
166	165.6	69	PSB-96W-UNI-24VDC						
168	168.0	70	PSB-96W-UNI-24VDC						
171	170.4	71	PSB-96W-UNI-24VDC						
173	172.7	72	PSB-96W-UNI-24VDC						
176	175.1	73	PSB-96W-UNI-24VDC						
178	177.5	74	PSB-96W-UNI-24VDC						
180	179.9	75	PSB-96W-UNI-24VDC						
183	182.3	76	PSB-96W-UNI-24VDC						
185	184.7	77	PSB-96W-UNI-24VDC						
188	187.1	78	PSB-96W-UNI-24VDC						
190	189.5	79	PSB-96W-UNI-24VDC						
192	191.8	80	PSB-96W-UNI-24VDC						
195	194.2	81	PSB-96W-UNI-24VDC						
197	196.6	82	PSB-96W-UNI-24VDC						
200	199.0	83	PSB-96W-UNI-24VDC						

*Maximum Chrome Shipping Length **Max Shipping Length

PROJECT		FIXTURE TYPE		DATE	
---------	--	--------------	--	------	--

Length Chart: Actual lengths for Zip Suspension Downlight - Remote Power Supply

27D & 30D (WARM DIM)							
Ordering Code (Nominal Size)	Actual Length (Inches)	5W (5 Watts)	Power Supply	Ordering Code (Nominal Size)	Actual Length (Inches)	5W (5 Watts)	Power Supply
48		20	PSB-40W-UNI-24VDC	147		61	PSB-96W-UNI-24VDC
51		21	PSB-40W-UNI-24VDC	150		63	PSB-96W-UNI-24VDC
54		23	PSB-40W-UNI-24VDC	153		64	PSB-96W-UNI-24VDC
57		24	PSB-40W-UNI-24VDC	156		65	PSB-96W-UNI-24VDC
60		25	PSB-40W-UNI-24VDC	159		66	PSB-96W-UNI-24VDC
63		26	PSB-40W-UNI-24VDC	162		68	PSB-96W-UNI-24VDC
66		28	PSB-40W-UNI-24VDC	165		69	PSB-96W-UNI-24VDC
69		29	PSB-40W-UNI-24VDC	168		70	PSB-96W-UNI-24VDC
72		30	PSB-40W-UNI-24VDC	171		71	PSB-96W-UNI-24VDC
75		31	PSB-40W-UNI-24VDC	174		73	PSB-96W-UNI-24VDC
78		33	PSB-40W-UNI-24VDC	177		74	PSB-96W-UNI-24VDC
81		34	PSB-40W-UNI-24VDC	180		75	PSB-96W-UNI-24VDC
84*		35	PSB-40W-UNI-24VDC	183		76	PSB-96W-UNI-24VDC
87		36	PSB-40W-UNI-24VDC	186		78	PSB-96W-UNI-24VDC
90		38	PSB-40W-UNI-24VDC	189		79	PSB-96W-UNI-24VDC
93		39	PSB-40W-UNI-24VDC	192		80	PSB-96W-UNI-24VDC
96		40	PSB-60W-UNI-24VDC	195		81	PSB-96W-UNI-24VDC
99		41	PSB-60W-UNI-24VDC	198		83	PSB-96W-UNI-24VDC
102		43	PSB-60W-UNI-24VDC	201		84	PSB-96W-UNI-24VDC
105		44	PSB-60W-UNI-24VDC	204		85	PSB-96W-UNI-24VDC
108		45	PSB-60W-UNI-24VDC	207		86	PSB-96W-UNI-24VDC
111		46	PSB-60W-UNI-24VDC	210		88	PSB-96W-UNI-24VDC
114		48	PSB-60W-UNI-24VDC	213		89	PSB-96W-UNI-24VDC
117		49	PSB-60W-UNI-24VDC	216		90	PSB-96W-UNI-24VDC
120**		50	PSB-60W-UNI-24VDC	219		91	PSB-96W-UNI-24VDC
123		51	PSB-60W-UNI-24VDC	222		93	PSB-96W-UNI-24VDC
126		53	PSB-60W-UNI-24VDC	225		94	PSB-96W-UNI-24VDC
129		54	PSB-60W-UNI-24VDC	228		95	PSB-96W-UNI-24VDC
132		55	PSB-60W-UNI-24VDC	231		96	PSB-96W-UNI-24VDC
135		56	PSB-60W-UNI-24VDC	234		98	PSB-100W-ELV-24VDC
138		58	PSB-60W-UNI-24VDC	237		99	PSB-100W-ELV-24VDC
141		59	PSB-60W-UNI-24VDC	240		100	PSB-100W-ELV-24VDC
144		60	PSB-96W-UNI-24VDC				

*Maximum Chrome Shipping Length **Max Shipping Length

PROJECT		FIXTURE TYPE		DATE	
---------	--	--------------	--	------	--

COMPONENTS Swag Bar & Hook, Swag Hook, and T-Bar are compatible with all Power Canopy options and may be required based on lighting design and application

NEW CONSTRUCTION & REMODEL 2" COVER FOR 4" SQUARE JUNCTION BOX

The New Construction NC2-JBOX Cover is included with the 2" Round and Square Canopies and is not required for the 4" Square Canopies. NC2 New Construction Junction Box Cover mounts to a standard 4" Electrical Box or Octagon Box, converting it to a 2" Plaster Ring for use with the 2R (Round) or 2S (Square) Canopy. The Remodel RM2-JBOX Plaster Plate cover is used with an existing 4" Square Junction Box and standard Round Plaster Ring. The PS-60L-ELV-24VDC (50 Watt IC, 60 Watt Non-IC) will fit inside the NC2 or RM2-JBOX Cover and Electrical Junction Box for a flush look.

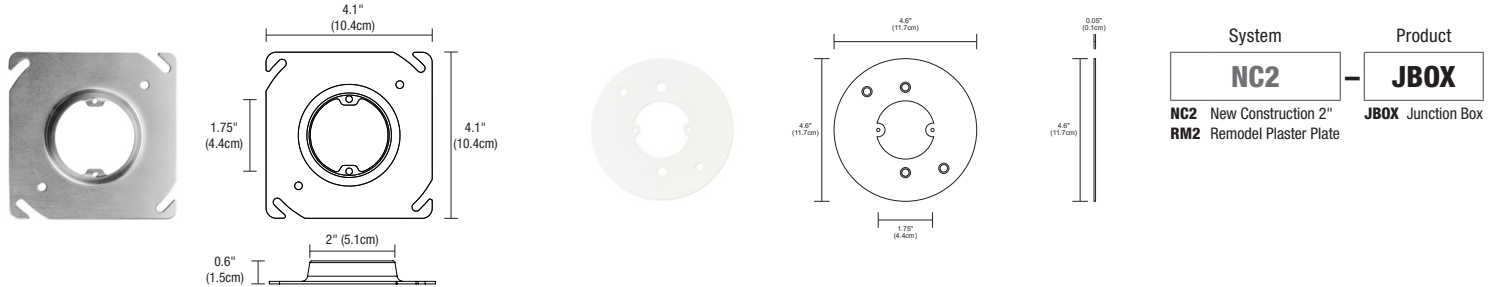

CIRRUS REMOTE POWER CANOPIES (INCLUDED)

Canopies are included with Canopy ordering code. The 2" Round and Square Canopy includes a special Plaster Ring NC2-JBOX (above). The 4" Square or Round Canopy fits on a standard 4" Electrical Box with Round Plaster Ring and the PS-60L-ELV-24VDC 50 Watt IC, 60 Watt Non-IC) will fit inside the NC2 or RM2-JBOX Cover and Electrical Junction Box for a flush look. Vanishing Point Plaster in system with No Canopy, only see cable going through drywall ceiling with GJ24.

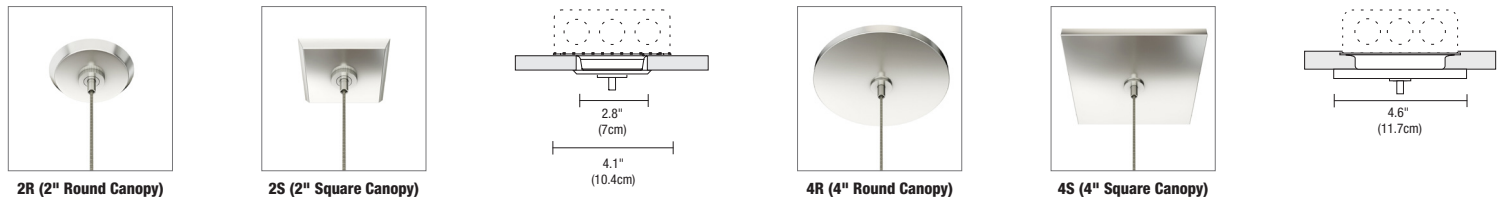

2 inch or 4 inch Canopy (Not Included)

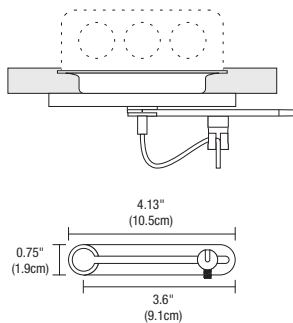

CHANNEL SUSPENSION ADJUSTABLE SWAG BAR AND HOOK

Channel Suspension Adjustable Swag Bar and Hook allows a cable to form a straight connection to the channel when the Power Canopy is not located directly above the fixture. Use when you have two or more canopies (power supplies) on the same fixture run. The Adjustable Swag Hook is compatible with the 2R, 2S, 4R and 4S Power Canopies (Canopy not included).

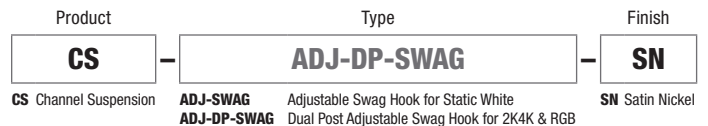

CHANNEL SUSPENSION SWAG HOOK

The clear plastic Swag Hook extends a cable from an electrical box that is not located directly above desired fixture location.

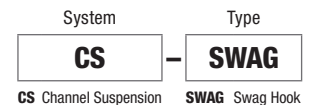
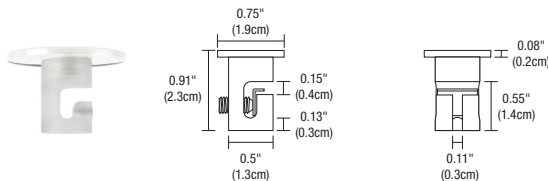

CHANNEL SUSPENSION ADJUSTABLE T-BAR CLIP

Channel Suspension Adjustable T-Bar Clip mounts to T-Bar grid ceilings. Available in Satin Nickel Hardware as Adjustable Power and Non-Power versions.

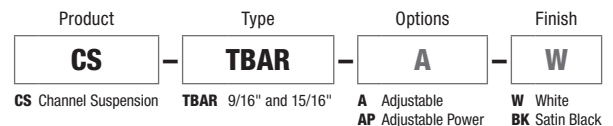
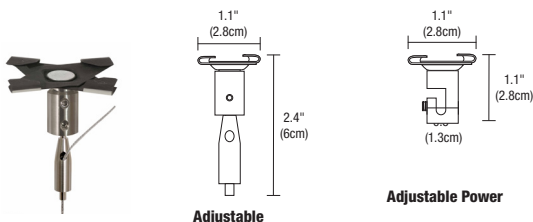

PROJECT	FIXTURE TYPE	DATE
---------	--------------	------

Drawings: Drawings are shown with 2 inch round canopy, 2 inch square canopy, 4 inch round canopy, and 4 inch square canopy

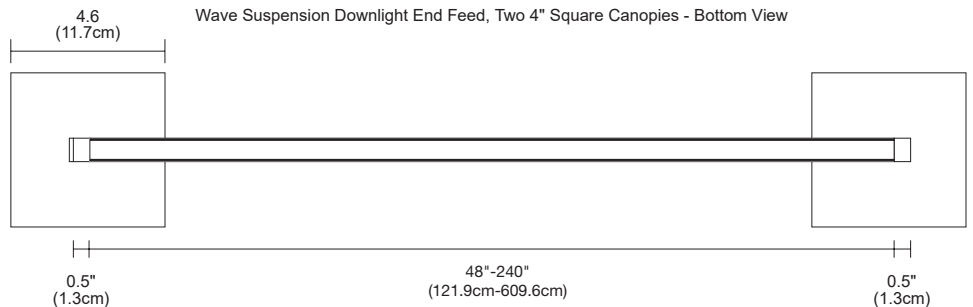
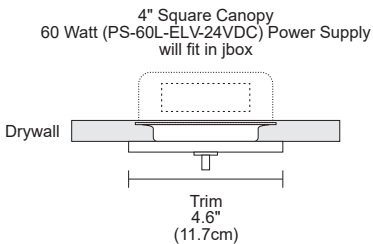
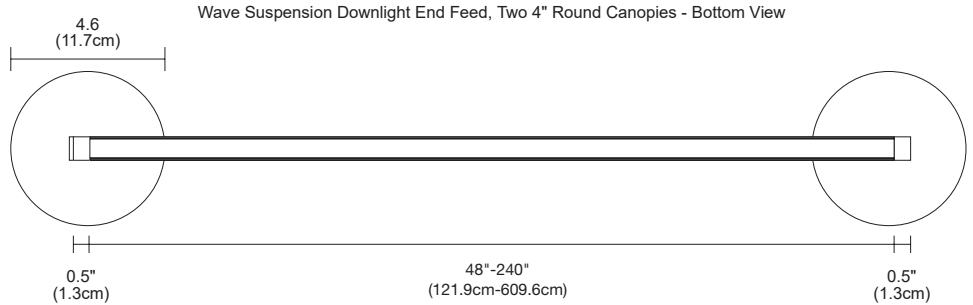
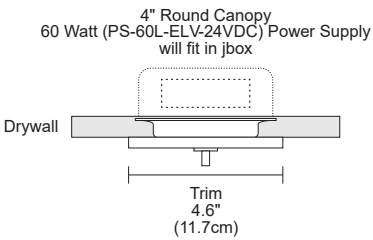
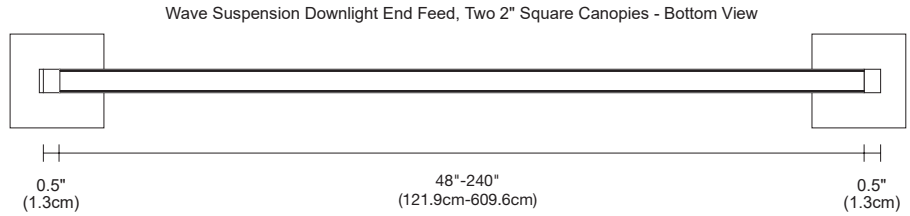
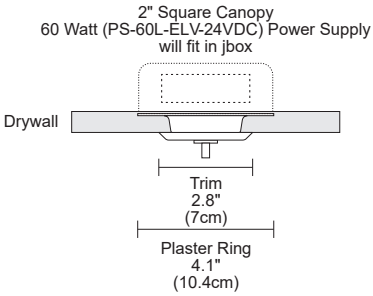
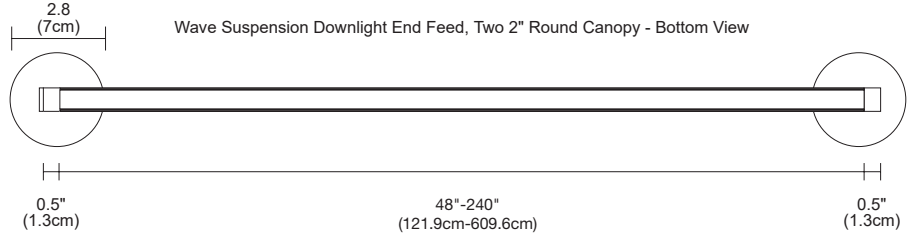
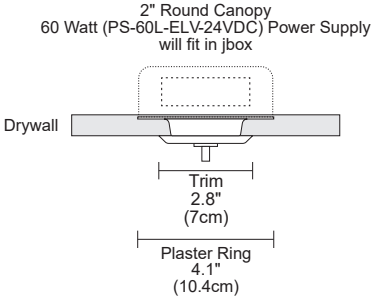

PROJECT		FIXTURE TYPE		DATE	
---------	--	--------------	--	------	--

Drawings: Side-view shown with 2 or 4 inch canopy

Zip Wave Suspension Downlight with Remote Power 4" Canopy Shown with Louver

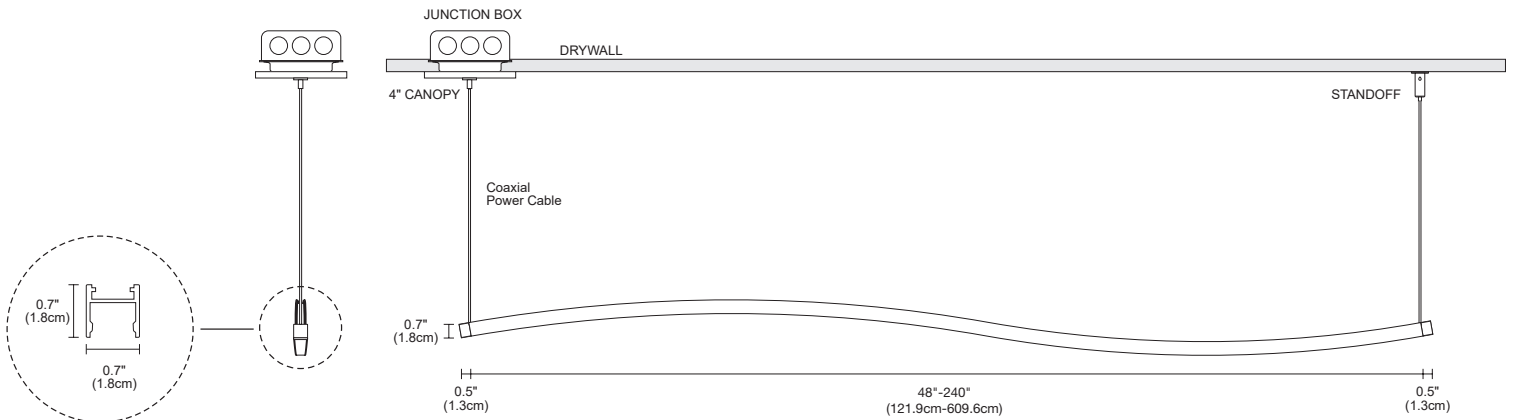

Zip Wave Suspension Downlight with Remote Power 2" Canopy Shown with Louver

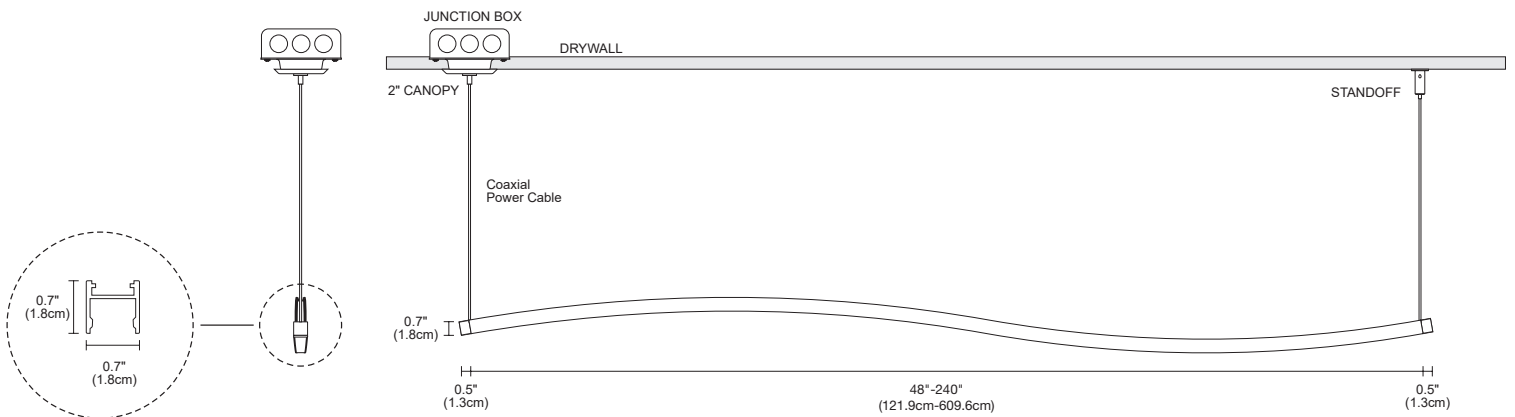

PROJECT		FIXTURE TYPE		DATE	
---------	--	--------------	--	------	--

Drawings: Side-view shown with two 2 and 4 inch canopies; one for remote power, one blank

Zip Wave Suspension Downlight with Remote Power 4" Canopies Shown with Louver

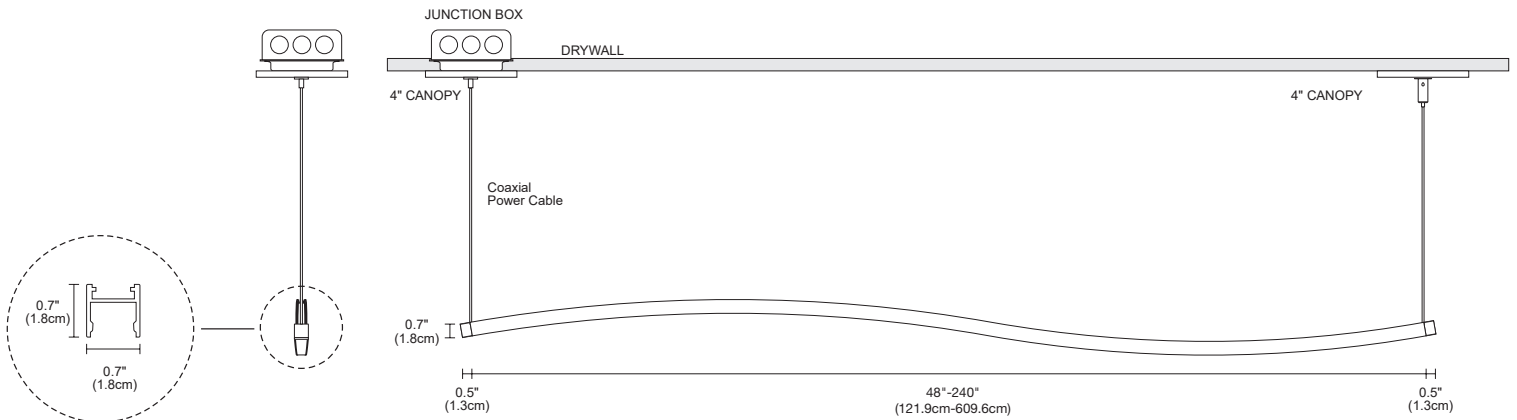

Zip Wave Suspension Downlight with Remote Power 2" Canopies Shown with Louver

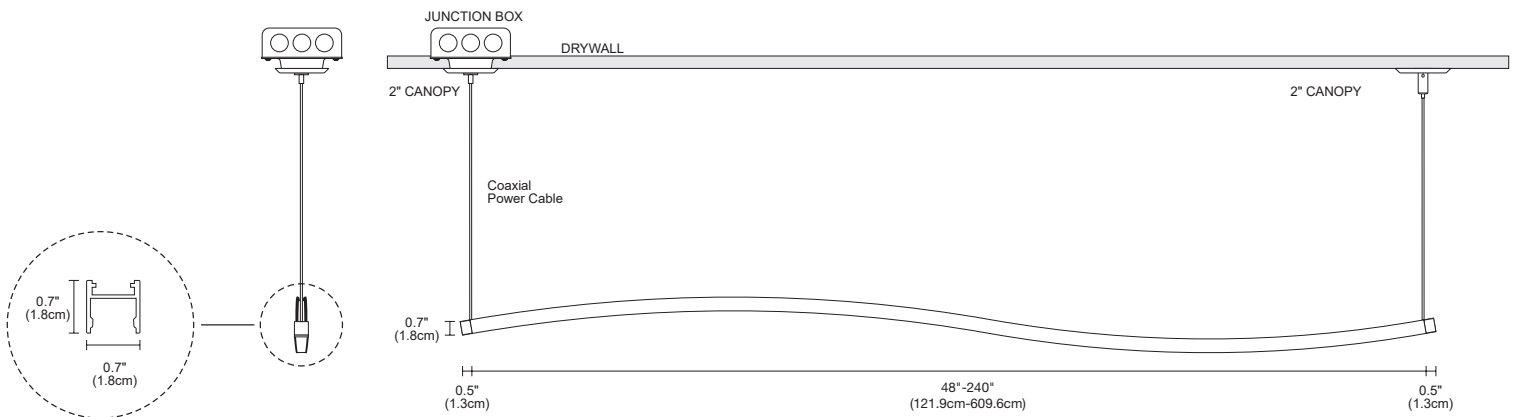

PROJECT		FIXTURE TYPE		DATE	
---------	--	--------------	--	------	--

Wiring Diagram: Wiring diagram for Static White with ELV Dimmer

- Application:** ELV dimming for Zip Wave Suspension Downlight with Remote Power, End Feed Canopy, Static White
- Power Supply:** Class 2, 24VDC output: 120VAC input, PS-60L-ELV-24VDC (Fits in Jbox)
- Remote Power Supplies:** PSB-60W-ELV-24VDC, PSB-100W-ELV-24VDC, UL 2108; PSB-200W-ELV-24VDC
- Dimming:** Dimmable with ELV dimmer: Legrand, Adorne ADTP703TU; Lutron: Diva DVELV-300P, Skylark SELVz-300P, Maestro MAELV-600 and Radio Ra 2

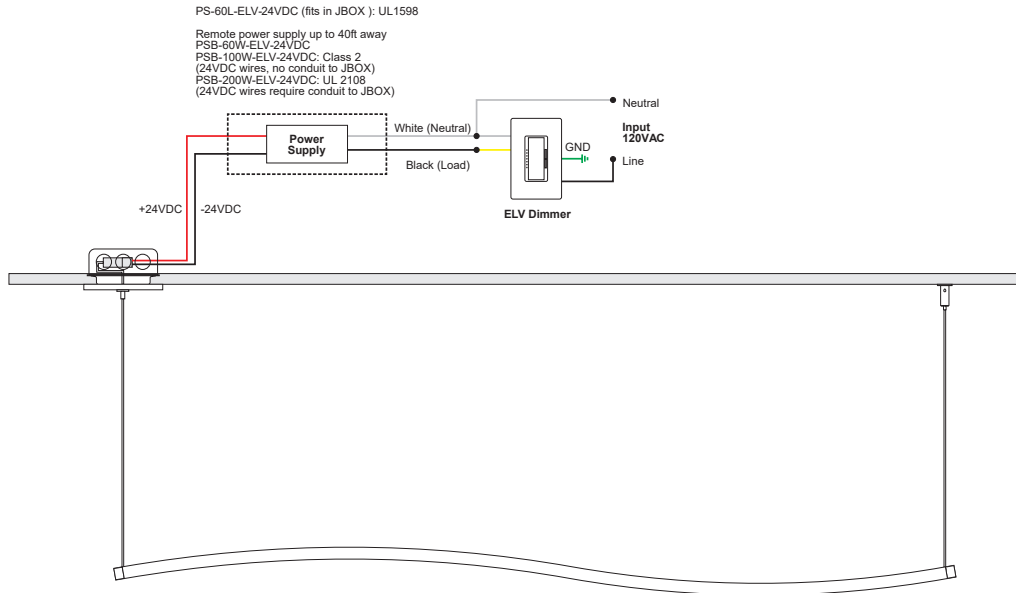

Wiring Diagram: Wiring diagram for Static White with 0-10 Volt Dimmer

- Application:** 0-10V dimming for Zip Wave Suspension Downlight with Remote Power, End Feed Canopy, Static White
- Remote Power Supplies:** UL Class 2, 24VDC output: 120/277 VAC input, PSB-60W-010-24VDC, PSB-100W-010-24VDC, UL 2108; PSB-200W-010-24VDC
- Dimming:** Dimmable with 0-10 dimmer: Philips: Sunrise SR1200ZTUNV; Lutron: Diva DDTV-WH, Nova-T NTSTV-DV-XX, Graftix Eye QS QSGRJ-XP, Radio RA2 RRD-1-ND; Leviton: LEV40050, IP710-LFZ; Legrand ADPD4FBL3P2W4

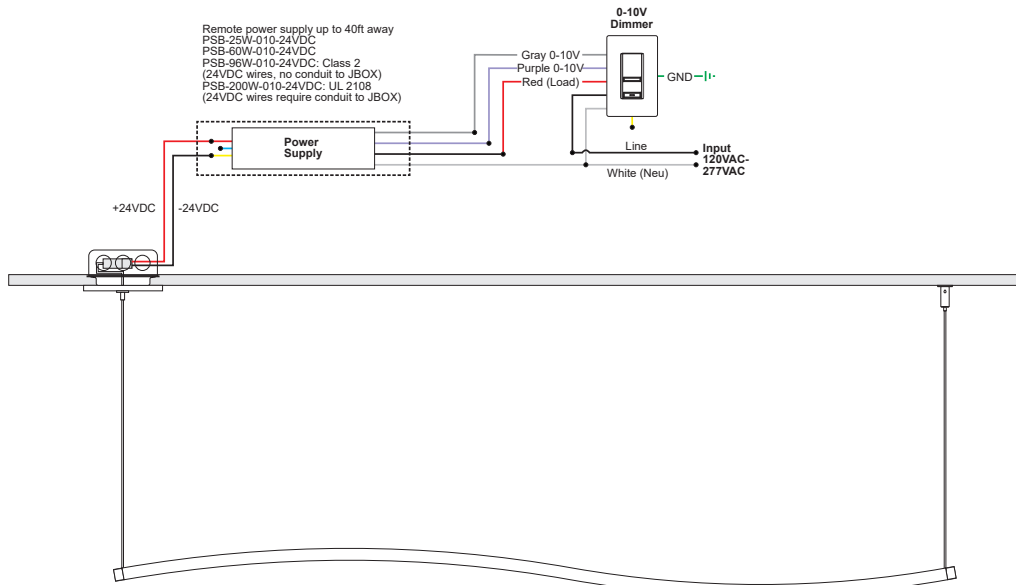

PROJECT	FIXTURE TYPE	DATE
---------	--------------	------

INDOOR CONSTANT VOLTAGE REMOTE POWER SUPPLIES

24VDC, UNI - UNIVERSAL DIMMING WITH ELV, TRIAC, & 0-10V

REV 07.16.20

UNIVERSAL POWER SUPPLIES & RECOMMENDED DIMMERS				
ORDERING CODE	PSB-40W-UNI-24VDC 	PSB-60W-UNI-24VDC 	PSB-2X40W-UNI-24VDC 	PSB-2X60W-UNI-24VDC
SPECIFICATIONS				
MAXIMUM LOAD	40W	60W	2X40W	2X60W
INPUT VOLTAGE	120-277VAC	120-277VAC	120-277VAC	120-277VAC
OUTPUT VOLTAGE	24VDC	24VDC	24VDC	24VDC
DIMENSIONS	12.4" X 3.12" X 2.18"	12.4" X 3.12" X 2.18"	12.15" X 6.48" X 2.18"	12.15" X 6.48" X 2.18"
CLASSIFICATION	CLASS 2	CLASS 2	CLASS 2	CLASS 2
IN-WALL MOUNTING	PSB-40W-UNI-24VDC-IW	PSB-60W-UNI-24VDC-IW	PSB-2X40W-UNI-24VDC-IW	PSB-2X60W-UNI-24VDC-IW
UNIVERSAL POWER SUPPLIES & RECOMMENDED DIMMERS				
ORDERING CODE	PSB-96W-UNI-24VDC 	PSB-2X96W-UNI-24VDC 	PSB-3X96W-UNI-24VDC 	PSB-4X96W-UNI-24VDC
SPECIFICATIONS				
MAXIMUM LOAD	96W	2X96W	3X96W	4X96W
INPUT VOLTAGE	120-277VAC	120-277VAC	120-277VAC	120-277VAC
OUTPUT VOLTAGE	24VDC	24VDC	24VDC	24VDC
DIMENSIONS	12.4" X 3.12" X 2.18"	12.15" X 6.48" X 2.18"	14" X 10" X 3"	17" X 13" X 3"
CLASSIFICATION	CLASS 2	CLASS 2	CLASS 2	CLASS 2
IN-WALL MOUNTING	PSB-96W-UNI-24VDC-IW	PSB-2X96W-UNI-24VDC-IW	NA	NA
ELV DIMMING & CONTROLS				
LUTRON DIVA: DVELV-300P	•	•	•	•
LUTRON SKYLARK: SELV-300P	•	•	•	•
LUTRON RADIO RA2: RRD-6NA	•	•	•	•
LUTRON MAESTRO: MAELV-600	•	•	•	•
LEGRAND ADORNE: ADTP-703TUM4	•	•	•	•
0-10 DIMMING & CONTROLS				
PHILIPS SUNRISE: SR1200ZTUNV	•	•	•	•
LUTRON DIVA: DVTW-WH, DVSTV-WH	•	•	•	•
LUTRON NOVA T: NTSTV-DV-XX	•	•	•	•
LUTRON GRAFIX EYE QS: QSGRJ-XP	•	•	•	•
LUTRON RADIO RA2: RRD-10ND	•	•	•	•
LEVITON: LEV40050	•	•	•	•
LEVITON IP710-LFZ	•	•	•	•
LEGRAND: ADPD4FBL3P2W4	•	•	•	•
TRIAC DIMMING & CONTROLS				
LUTRON SKYLARK: S2-L-WH	•	•	•	•
LUTRON DIVA DVLV-600P-WH	•	•	•	•
LUTRON DIVA DVLV-603P-WH	•	•	•	•
LUTRON MAESTRO MALV-600-WH	•	•	•	•
LUTRON MAESTRO MALV-1000-WH	•	•	•	•
LUTRON MAESTRO MA-R-XX	•	•	•	•

- Flicker free dimming
- Aluminum casing for optimal heat dissipation
- Isolated output power per NEC and UL safety requirements
- UL & ETL recognized/ listed, meets UL 8750, 1310 requirements
- Auto-reset: short circuit, overload and thermal protection
- Class 2 power supply
- Efficient, High power factor > 0.90
- The Solid State Constant Voltage Uni-Power Supply is compatible with most commercially available Dimmers:
 - Triac Dimmer : (Forward Phase) Typically used for the dimming of Incandescent and Low Voltage Magnetic Transformers
 - ELV Dimmer : (Reverse Phase) Dimming of Electronic Low Voltage Transformers and Power Supply's used for LED lighting
 - 0-10 Dimmer : Dims the Low Voltage side of a 0-10 volt power supply commonly used in large scale lighting or commercial applications.
- The Uni-Power Supply is recommended with any Siemens/Murray brand of arc fault breaker to overcome the issues with tripping the breakers with an ELV LED Low Voltage Drivers.

PROJECT	FIXTURE TYPE	DATE
---------	--------------	------

IN WALL MOUNTING OPTIONS

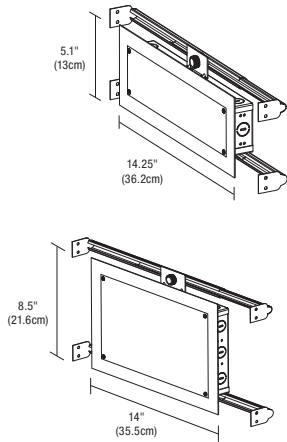

In-Wall Mounting Kit: Includes power supply, box cover and stud hangers for installing Junction Box in wall. Select "IW" in the options section of compatible power supply ordering codes if an In-Wall Mounting Kit is needed.

Ordering Codes 5.1 x 14.25 inch: PSB-40W-UNI-24VDC-IW
PSB-60W-UNI-24VDC-IW
PSB-96W-UNI-24VDC-IW

Ordering Codes 8.5 x 14.25 inch: PSB-2X40W-UNI-24VDC-IW
PSB-2X60W-UNI-24VDC-IW
PSB-2X96W-UNI-24VDC-IW

WIRING DIAGRAMS UNIVERSAL POWER SUPPLY

Application: Triac dimming for two power supplies, use for Static White, Dynamic/Tunable White 2000K-4000K

Dimming: Dimmable with Triac dimmer: Lutron: Skylark S2-L

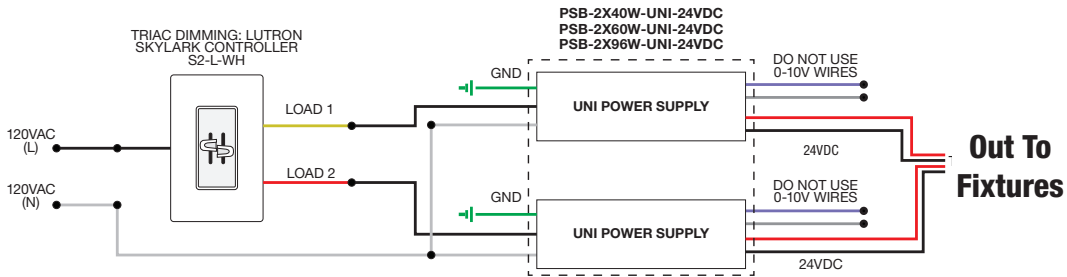

Application: ELV dimming for Static White and Warm Dim

Dimming: Dimmable with ELV dimmer: Legrand, Adorne ADTP703TU; Lutron: Diva DVELV-300P, Skylark SELV-300P, Maestro MAELV-600 and Radio Ra 2

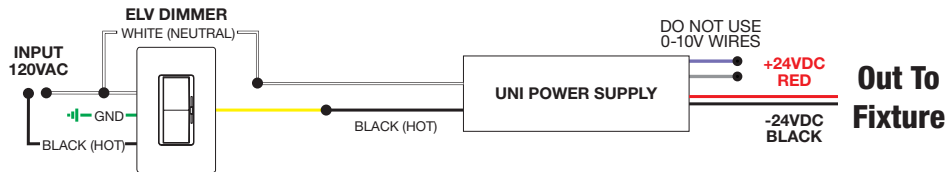

Application: 0-10V dimming for Static White

Dimming: Dimmable with 0-10V dimmer: Philips Sunrise: SR1200ZTUNV; Lutron Diva: DVTV-WH, DVSTV-WH; Lutron Nova T: NTSTV-DV-XX; Lutron Grafix EYE QS: QSGRJ-XP; Lutron Radio Ra2: RRD-10ND; Leviton: LEV40050; Leviton IP710-LFZ; Legrand: ADPD4FBL3P2W4

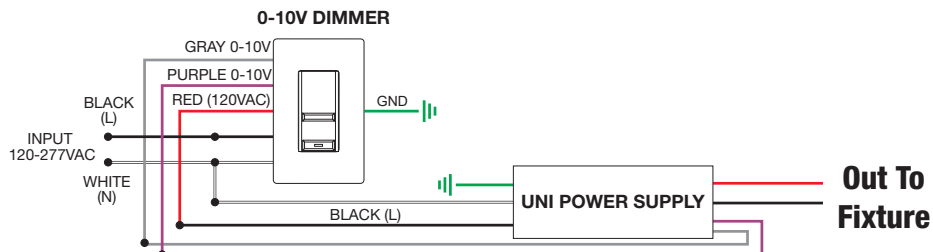

PROJECT		FIXTURE TYPE		DATE	
---------	--	--------------	--	------	--

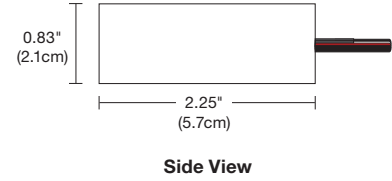
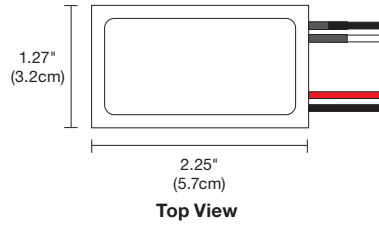
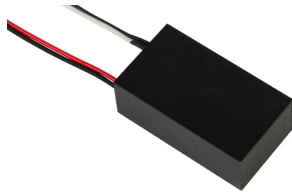

DESCRIPTION

Compact, lightweight remote electronic 60W/24V LED Power Supply* converts standard 120VAC voltage to 24VDC and features built-in short-circuit protection. The low voltage output may be dimmed using an electronic low voltage dimmer. The Power Supply is certified to be used inside a standard Junction Box enclosure. Power Supply features short circuit and overload protection. Indoor applications only.

**Electrical Panels using Seimens/Murray AFCI breakers are not compatible with this ELV transformer. Use 0-10 Volt power supplies with this breaker.*

APPLICATIONS

Indoor*
To avoid overheating the power supply, install it in a ventilated remote location where air flows. Maintain proper spacing among power supplies when multiple power supplies are installed in the same remote location.

- POWER INPUT** 120 volts AC, 60Hz
- POWER OUTPUT** Class 2; 24 volts DC 2.5A 60 watt maximum
- DIMENSIONS** 2.25" x 1.25" x 0.83"
- DIMMER TYPE** Electronic Low Voltage Dimmer Lutron: Diva #DVELV-300P; Skylark #SELV-300P; Maestro #MAELV-600

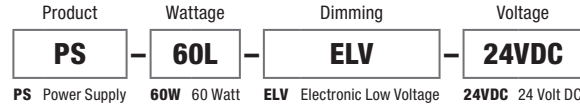
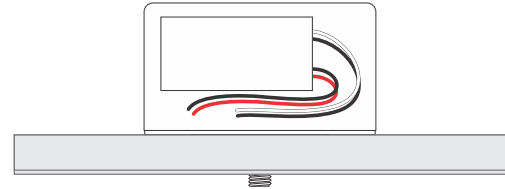

SAMPLE WIRING DIAGRAMS 24VDC ELV

- Application:** ELV dimming for Static White
- Dimming:** Dimmable with ELV dimmer: Legrand, Adorne ADTP703TU; Lutron: Diva DVELV-300P, Skylark SELV-300P, Maestro MAELV-600 and Radio Ra 2

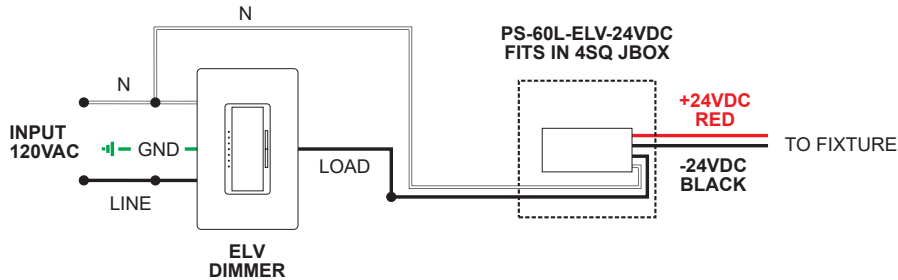

- Application:** Dual ELV dimming for Dynamic/Tunable White 2000K-4000K
- Dimming:** Dimmable with ELV dimmer: Legrand, Adorne ADTP703TU; Lutron: Diva DVELV-300P, Skylark SELV-300P, Maestro MAELV-600 and Radio Ra 2

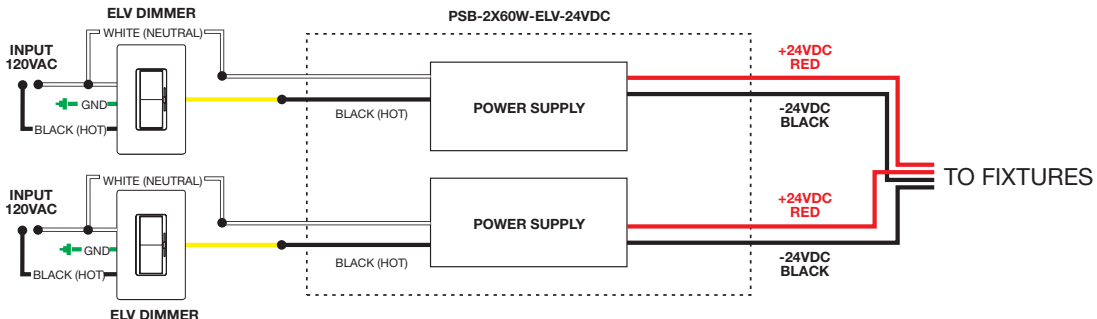

PROJECT	FIXTURE TYPE	DATE
---------	--------------	------

SUSPENSION TM30 DATA

LED SUSPENSION DOWNLIGHT WITH REMOTE POWER - END FEED

TM-30-15 DATA: The data below is for SS2C, SS5C, SS7C, and SS10C bare LED Soft Strips. Consistent color temperatures throughout a single strip and among multiple strips is possible through a 3 phase binning process in which each order is inspected with a color meter to ensure uniformity.

2200K | Rf: 83.9 | Rg: 94.9

Color Vector Graphic

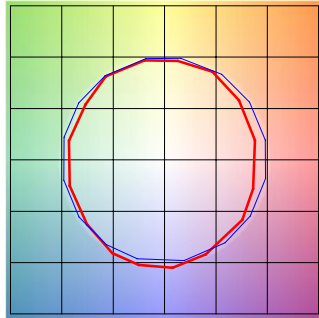

■ Test ■ Reference

		GRAPHIC SHIFTS %	
HUE BIN	Rf	CHROMA	HUE
1	77.6	-10.0%	1.8%
2	80.7	-7.5%	7.0%
3	79.5	-2.9%	8.9%
4	90.5	-3.1%	2.4%
5	93.9	-1.3%	1.9%
6	91.9	-0.9%	-0.2%
7	87.6	-6.3%	-2.7%
8	90.5	-5.4%	2.7%
9	83.8	-4.7%	6.5%
10	81.2	-2.5%	10.0%
11	83.3	3.9%	9.4%
12	86.4	5.6%	2.6%
13	86.2	4.5%	-12.4%
14	64.3	-1.0%	-21.9%
15	85.1	-4.4%	-7.5%
16	75.0	-9.9%	-12.0%

2400K | Rf: 91.2 | Rg: 96.8

Color Vector Graphic

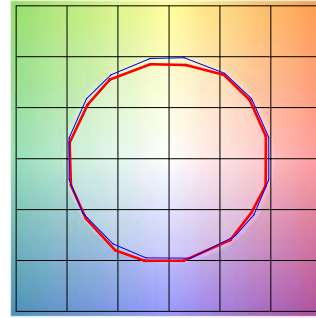

■ Test ■ Reference

		GRAPHIC SHIFTS %	
HUE BIN	Rf	CHROMA	HUE
1	92.0	-2.4%	1.5%
2	94.7	-2.1%	0.0%
3	95.4	-1.9%	-0.1%
4	88.7	-6.7%	-3.1%
5	92.8	-5.6%	1.0%
6	92.7	-3.4%	3.4%
7	89.9	-4.3%	4.1%
8	92.4	-1.4%	4.4%
9	89.0	-0.6%	5.8%
10	86.9	0.4%	6.2%
11	89.7	4.0%	5.4%
12	92.6	3.0%	-0.7%
13	90.9	1.1%	-7.0%
14	89.9	0.5%	-5.8%
15	92.1	-3.2%	0.1%
16	88.9	-1.7%	-6.3%

2700K | Rf: 87.7 | Rg: 96.1

Color Vector Graphic

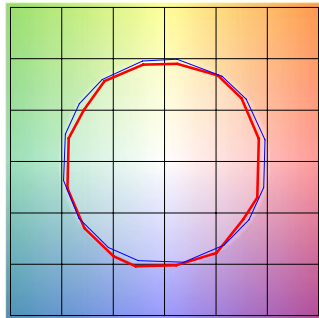

■ Test ■ Reference

		GRAPHIC SHIFTS %	
HUE BIN	Rf	CHROMA	HUE
1	86.4	-5.6%	2.3%
2	89.7	-3.3%	3.1%
3	90.5	-1.5%	3.8%
4	90.0	-4.3%	1.1%
5	92.9	-3.7%	0.2%
6	93.5	-2.5%	-0.8%
7	86.3	-7.2%	2.5%
8	90.7	-4.0%	3.2%
9	85.2	-2.4%	8.1%
10	81.7	0.9%	10.8%
11	85.4	4.5%	8.9%
12	88.7	5.7%	-1.4%
13	88.3	1.3%	-7.9%
14	85.1	2.4%	-10.4%
15	88.1	-4.8%	-2.7%
16	81.7	-4.3%	-10.9%

3000K | Rf: 88.1 | Rg: 99.7

Color Vector Graphic

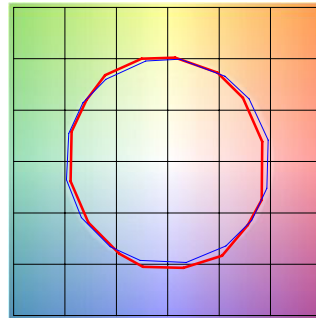

■ Test ■ Reference

		GRAPHIC SHIFTS %	
HUE BIN	Rf	CHROMA	HUE
1	87.7	-5.9%	-0.3%
2	87.9	-4.4%	4.3%
3	82.9	-1.2%	7.9%
4	89.9	0.6%	4.7%
5	92.7	3.0%	3.5%
6	92.7	3.6%	-1.7%
7	90.8	-1.3%	-4.4%
8	93.7	-2.5%	-2.2%
9	91.7	-3.7%	2.3%
10	85.5	-2.8%	7.8%
11	83.3	0.7%	11.0%
12	86.4	5.5%	3.8%
13	90.6	4.6%	-3.6%
14	85.6	5.9%	-8.4%
15	89.5	-0.6%	-5.7%
16	82.6	-2.7%	-12.0%

3500K | Rf: 86.1 | Rg: 95.5

Color Vector Graphic

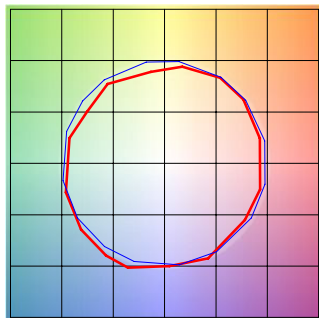

■ Test ■ Reference

		GRAPHIC SHIFTS %	
HUE BIN	Rf	CHROMA	HUE
1	86.6	-4.2%	3.4%
2	91.7	-1.4%	1.8%
3	94.9	-0.7%	0.4%
4	87.9	-4.5%	-4.1%
5	85.9	-10.3%	-2.7%
6	89.8	-5.2%	-0.4%
7	79.6	-9.5%	6.5%
8	87.6	-4.0%	5.7%
9	81.4	-0.5%	11.8%
10	78.3	3.3%	11.4%
11	85.7	6.3%	6.1%
12	86.3	7.1%	-4.6%
13	86.1	-0.7%	-9.6%
14	85.1	0.8%	-10.4%
15	83.4	-4.1%	-5.3%
16	82.5	-3.6%	-5.7%

4000K | Rf: 87.6 | Rg: 96.8

Color Vector Graphic

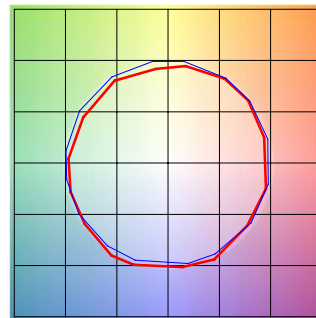

■ Test ■ Reference

		GRAPHIC SHIFTS %	
HUE BIN	Rf	CHROMA	HUE
1	89.0	-3.1%	2.1%
2	93.2	-0.9%	1.3%
3	94.3	-1.1%	0.7%
4	89.5	-4.0%	-2.3%
5	87.6	-7.8%	-1.8%
6	92.2	-4.6%	0.1%
7	87.4	-6.6%	3.6%
8	85.7	-3.8%	7.0%
9	81.5	-1.3%	12.4%
10	80.0	0.9%	11.4%
11	83.3	5.9%	8.7%
12	89.7	4.8%	-0.3%
13	88.5	2.4%	-6.3%
14	92.7	4.0%	-3.8%
15	86.1	-1.6%	-4.5%
16	85.0	-1.4%	-5.0%

PROJECT	FIXTURE TYPE	DATE
---------	--------------	------

SUSPENSION TM30 DATA

LED SUSPENSION DOWNLIGHT WITH REMOTE POWER - END FEED

TM-30-15 DATA: The data below is for SS2C, SS5C, SS7C, and SS10C bare LED Soft Strips. Consistent color temperatures throughout a single strip and among multiple strips is possible through a 3 phase binning process in which each order is inspected with a color meter to ensure uniformity.

5700K | Rf: 80.3 | Rg: 91.5

Color Vector Graphic

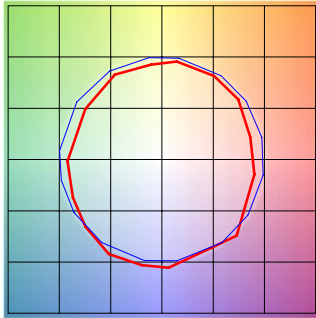

■ Test ■ Reference

HUE BIN	Rf	GRAPHIC SHIFTS %	
		CHROMA	HUE
1	73.8	-11.2%	2.6%
2	83.7	-5.5%	5.8%
3	84.2	-4.0%	5.5%
4	85.8	-3.5%	1.3%
5	85.3	-7.1%	0.6%
6	89.2	-5.8%	-2.2%
7	81.5	-10.7%	1.2%
8	75.7	-9.7%	8.5%
9	74.9	-7.8%	18.8%
10	67.8	-1.6%	18.0%
11	76.1	5.5%	12.0%
12	90.8	4.9%	-1.6%
13	83.6	5.0%	-9.5%
14	81.7	-1.2%	-10.0%
15	69.0	2.0%	-22.8%
16	83.2	-8.5%	-1.0%

2700D | Rf: 89.5 | Rg: 100.8

Color Vector Graphic

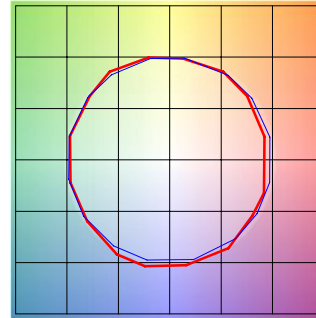

■ Test ■ Reference

HUE BIN	Rf	GRAPHIC SHIFTS %	
		CHROMA	HUE
1	88.8	-5.1%	1.4%
2	89.8	-2.7%	4.1%
3	87.2	0.3%	5.9%
4	92.3	-0.9%	1.0%
5	93.3	1.5%	1.7%
6	92.4	3.6%	-0.2%
7	92.2	-0.9%	-2.4%
8	96.7	-0.4%	-1.1%
9	92.3	-1.2%	3.7%
10	88.9	-0.0%	6.1%
11	86.4	5.1%	7.4%
12	88.2	6.3%	-0.9%
13	87.2	3.8%	-8.1%
14	84.2	3.8%	-11.0%
15	89.8	-2.6%	-4.3%
16	82.7	-3.4%	-11.1%

3000D | Rf: 89.8 | Rg: 101.4

Color Vector Graphic

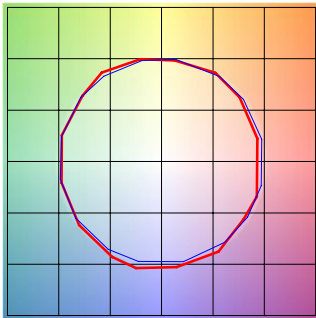

■ Test ■ Reference

HUE BIN	Rf	GRAPHIC SHIFTS %	
		CHROMA	HUE
1	90.2	-4.2%	1.5%
2	90.9	-2.0%	3.7%
3	87.9	0.8%	5.5%
4	92.1	-0.9%	0.6%
5	93.0	1.5%	1.6%
6	92.2	3.9%	-0.2%
7	92.1	-0.3%	-2.0%
8	96.7	0.0%	-1.2%
9	92.5	-0.6%	3.7%
10	88.3	1.1%	7.0%
11	87.2	4.1%	7.4%
12	87.2	6.7%	-1.0%
13	88.2	3.8%	-7.2%
14	85.3	4.3%	-9.9%
15	90.9	-2.2%	-3.6%
16	83.4	-2.2%	-11.2%

PROJECT	FIXTURE TYPE	DATE
---------	--------------	------