

SS3 GGG SOFT STRIP

2.6W, 24VDC HIGH OUTPUT, GREEN ONLY

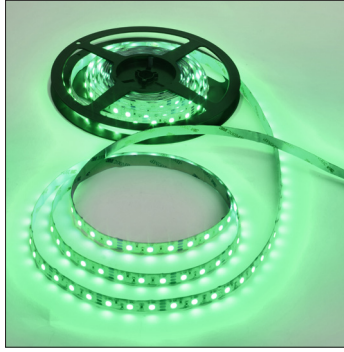

DESCRIPTION

Soft Strip (SS3) GGG provides dynamic color effects with Green LEDs. The 0.5" wide flexible Copper Strip, with an optically clear protective coating, is sold in 1' increments up to 36' with cutting increments every 4". Snap & Light Power Connector is required and sold separately (pages 3-4). Additional Snap & Light Connectors (pages 3-4) are also available for making custom configurations. At only 2.6 watts per foot, this system uses an electronic low-voltage or 0-10V power supply (sold separately). Self-adhering SS3 mounts to most smooth finished surfaces with the industrial strength 3M tape (provided on back of strip); some unfinished surfaces may require screw-in mounting clips (sold separately). Designed for indoor, open-air environments, SS3 includes a flexible aluminum heat sink to extend LED life. Soft Strip is compatible with solderless Snap & Light Connectors.

APPLICATIONS

Indoor Only - Under/Above Cabinet, Ccove Lighting or Accent Toe-Kicks, behind sheer Curtains, Step, Entertainment, Display, Night Clubs, Molding Accent, and Media Room

LAMPING

(18) Green LEDs per foot, LED Lamps consume 2.6 watts per foot
The average LED Life is 50,000 hours

24VDC POWER SUPPLIES (SOLD SEPARATELY)

- **PSB-96W-010-24VDC** 120-277VAC input, 96 watt output
- **PSB-2X96W-010-24VDC** 120-277VAC input, 2x96 watt output
- **PSB-3X96W-010-24VDC** 120-277VAC input, 3x96 watt output
- **PSB-4X96W-010-24VDC** 120-277VAC input, 4x96 watt output
- **PSB-60W-ELV-24VDC*** 120VAC input, 60 watt output
- **PSB-100W-ELV-24VDC*** 120VAC input, 96 watt output
- **PSB-2X100W-ELV-24VDC*** 120VAC input, 2x96 watt output
- **PSB-3X100W-ELV-24VDC*** 120VAC input, 3x96 watt output
- **PSB-4x100W-ELV-24VDC*** 120VAC input, 4x96 watt output

* Electrical Panels using Seimens/Murray AFCI breakers are not compatible with this ELV transformer. Use 0-10 Volt power supplies with this breaker.

MOUNTING STRAPS & CLIPS (PG. 5)

- **SS-SU** Use U-Strap every 6"-12" for extra support (30 per package)
- **SS-ST** Use Tie Strap every 6"-12" for extra support (30 per package)
- **SS-MCL** Mounts beneath Strip, snapping Strip in place for additional support (10 per package)

WARRANTY / LABELS

5 year warranty. Assembled in America

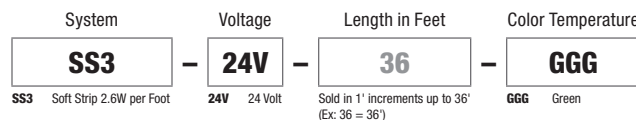
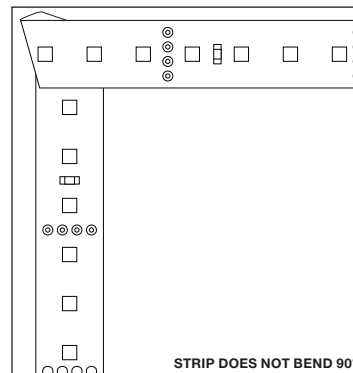
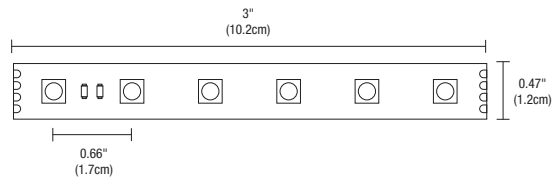

PROJECT	FIXTURE TYPE	DATE
---------	--------------	------

SS3 GGG SOFT STRIP

2.6W, 24VDC HIGH OUTPUT, GREEN ONLY

LENGTH CHART Actual Lengths for SS3 AAA Soft Strip

SS3 GGG SOFT STRIP							
36' MAXIMUM LENGTH BEFORE RE-FEEDING							
LENGTH IN FEET	TOTAL WATTAGE	LENGTH IN FEET	TOTAL WATTAGE	LENGTH IN FEET	TOTAL WATTAGE	LENGTH IN FEET	TOTAL WATTAGE
1	3	10	26	19	50	28	73
2	6	11	29	20	52	29	76
3	8	12	32	21	55	30	78
4	11	13	34	22	58	31	81
5	13	14	37	23	60	32	84
6	16	15	39	24	63	33	86
7	19	16	42	25	65	34	89
8	21	17	45	26	68	35	91
9	24	18	47	27	71	36	94

WIRING DIAGRAM

- APPLICATION** Electronic Low Voltage dimming for SS3 GGG Soft Strip
- POWER SUPPLY** PSB-60W-ELV-24VDC: 120VAC input, 24VDC 60 watt output
- DIMMING** Dimmable with Low Voltage Electronic dimmer using Power Supply*
 Lutron: Diva DVELV-300P; Skylark SELV-300P; Maestro MAELV-600 dimmers are recommended
 *See Power Supply Spec Sheet for additional details.

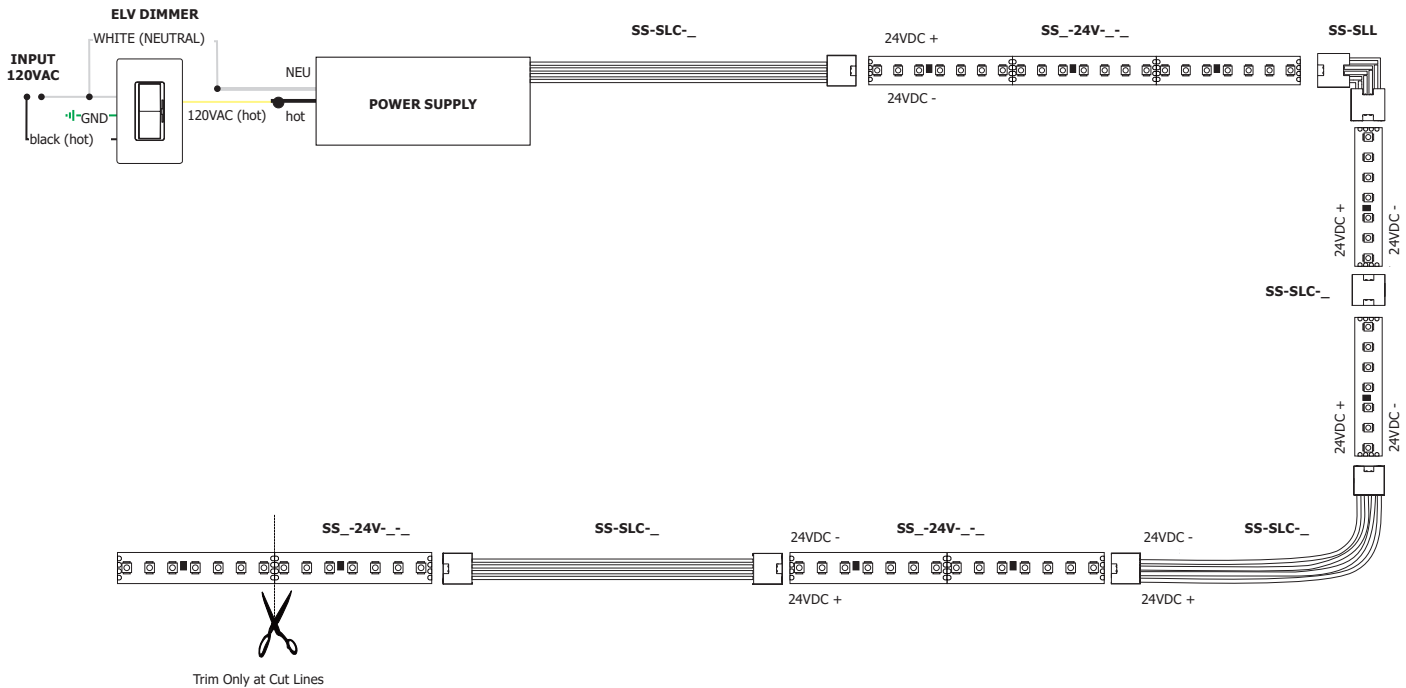

PROJECT	FIXTURE TYPE	DATE
---------	--------------	------

SS3 GGG SOFT STRIP

2.6W, 24VDC HIGH OUTPUT, GREEN ONLY

WIRING DIAGRAM

- APPLICATION** 0-10V dimming for SS3 GGG Soft Strip
- POWER SUPPLY** Class 2, 24VDC output: 120-277VAC input, 96 watt output PSB-96W-010-24VDC
- DIMMING** Dimmable with 0-10V dimmer using Power Supply*
Philips Sunrise SR1200ZTUNV, 0-10V dimmer recommended
*See Power Supply Spec Sheet for additional details.

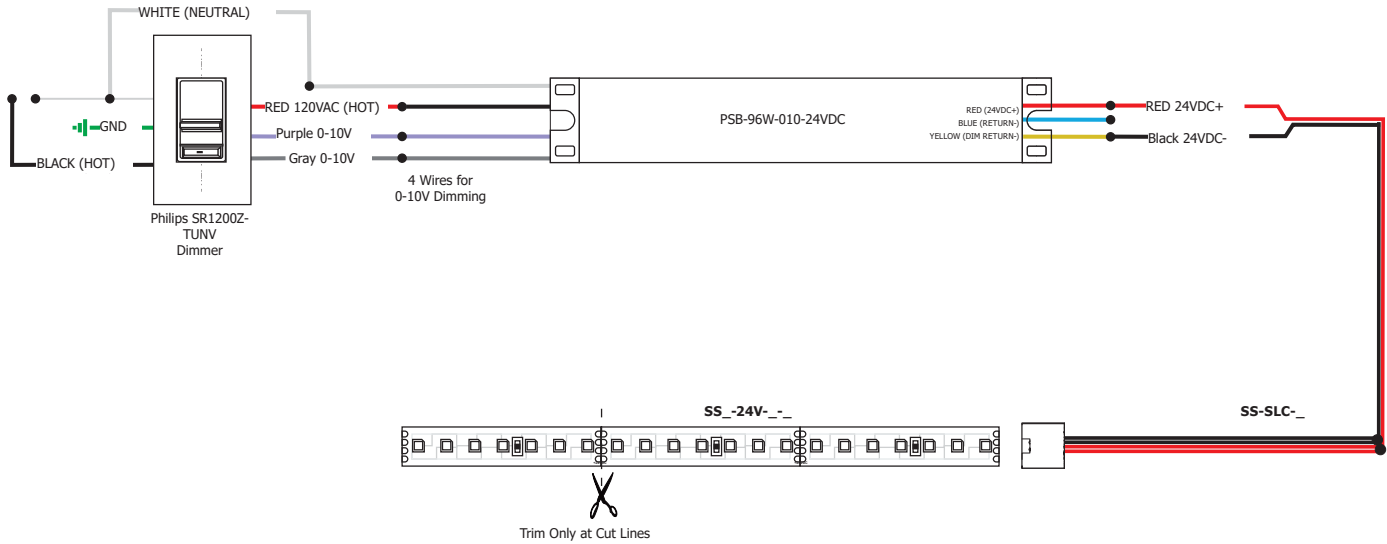

SNAP & LIGHT ACCESSORIES

Snap & Light Accessories provide easy connection of White or RGB Soft Strip sections. The Do-It-Yourself Accessories, without limitations, allow cutting and rejoining of Soft Strip at any point. The accessories attach to the end of Soft Strip, secure the Strip and snap shut to lock it into place. Snap & Light Accessories ensure a tightly sealed connection, while the gold plated pins provide better connectivity without oxidation.



Cut in middle of joining contacts



Scrape protective coating from contacts

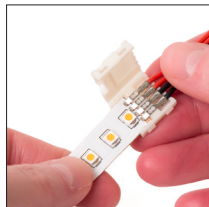

Place the Strip end under the plastic guide and push under the snap contacts

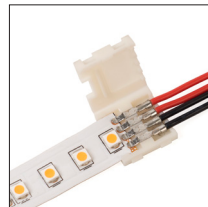

Close the cover

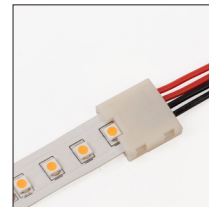

Snap the cover to secure in place

PROJECT		FIXTURE TYPE		DATE	
---------	--	--------------	--	------	--

SS3 GGG SOFT STRIP

2.6W, 24VDC HIGH OUTPUT, GREEN ONLY

SNAP & LIGHT ACCESSORIES (CONT'D)

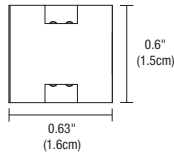

SNAP & LIGHT STRAIGHT JOINER CONNECTOR

Snap & Light Straight Joiner Connectors join two cut sections of White or RGB Soft Strip end-to-end.

Product	Type
SS	SLC
SS Soft Strip	SLC Snap & Light Straight Connector

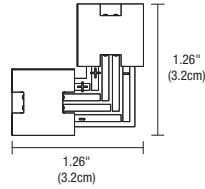
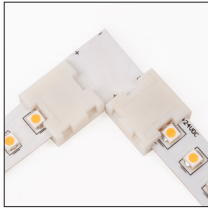

SNAP & LIGHT L-CONNECTOR

Snap & Light L-Connectors join and conduct power to two sections of White or RGB Soft Strip in an L-Shape.

Product	Type
SS	SLL
SS Soft Strip	SLL Snap & Light L-Connector

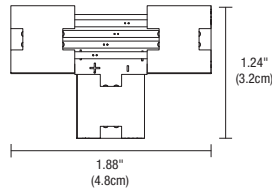
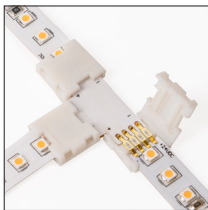

SNAP & LIGHT T-CONNECTOR

Snap & Light T-Connectors join and conduct power to three sections of White or RGB Soft Strip in a T-Shape.

Product	Type
SS	SLT
SS Soft Strip	SLT Snap & Light T-Connector

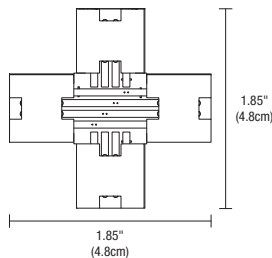
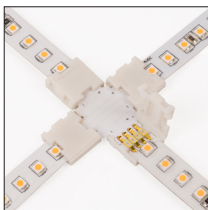

SNAP & LIGHT X-CONNECTOR

Snap & Light X-Connectors join and conduct power to four sections of White or RGB Soft Strip in an X-Shape.

Product	Type
SS	SLX
SS Soft Strip	SLX Snap & Light X-Connector

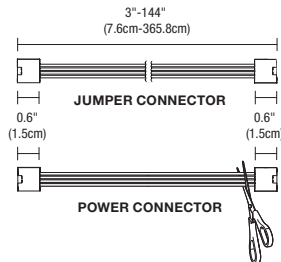
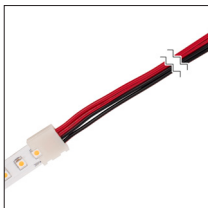

SNAP & LIGHT JUMPER OR POWER CONNECTOR

Snap & Light Jumper or Power Connectors join two cut sections of White or RGB Soft Strip end-to-end. Cut and strip the connector wires to use as a Power Connector.

Product	Type	Size
SS	SLC	12IN
SS Soft Strip	SLC Snap & Light Jumper or Power Connector	
		3IN 3"
		6IN 6"
		12IN 12"
		36IN 36"
		96IN 96"
		144IN 144"

PROJECT	FIXTURE TYPE	DATE
---------	--------------	------

SS3 GGG SOFT STRIP

2.6W, 24VDC HIGH OUTPUT, GREEN ONLY

SNAP & LIGHT ACCESSORIES (CONT'D)

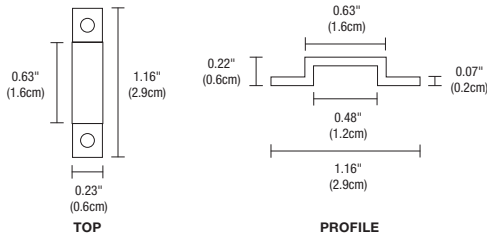

SOFT STRIP U-STRAP

Use U-Strap every 6"-12" for extra support (30 per package).

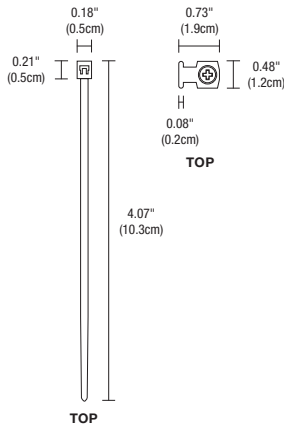
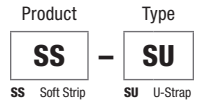

SOFT STRIP TIE STRAP

Use Tie Strap every 6"-12" for extra support (30 per package).

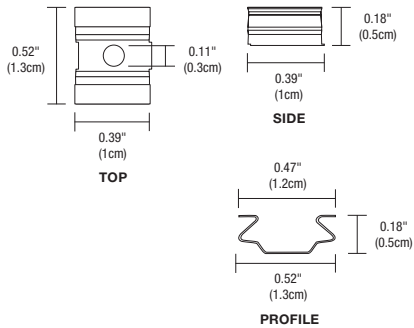
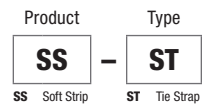

SOFT STRIP MOUNTING CLIP

Screw-In Mounting Clip mounts beneath strip, snapping the Strip into place for additional support (10 per package).

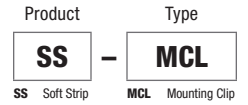

PROJECT		FIXTURE TYPE		DATE	
---------	--	--------------	--	------	--