



SS2C, SS5C, SS7C & SS10C COMMERCIAL STATIC WHITE SOFT STRIP

(2.5W, 5W, 7W, & 10W) 24VDC HIGH OUTPUT



DESIGNED BY GREGORY KAY | ASSEMBLED IN AMERICA

REV 03.16.20

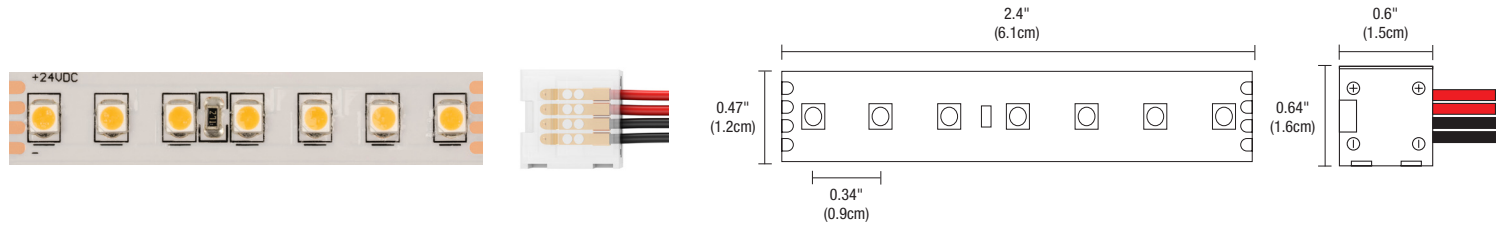

FEATURES & BENEFITS

- Snap & Light Solderless Connectors reduce labor during installation
- Gold Plated Contacts prevent oxidation to ensure long LED life
- 35 LEDs per foot provide uniform light distribution without dots when using a Diffuser Lens (Light Channel .3 will have visible dots)
- 5 oz of copper provides better heat dissipation and less voltage drop
- Premium, optically clear silicone coating prevents fading
- 24VDC LED Soft Strip offers 6 white color temperatures all with high CRI and name brand LEDs
- 7 Color Temperatures and may be ordered in Warm Dim or Tunable White
- 7 LEDs per cutting increment provide 87.5% efficiency compared to 6 LEDs at only 75%. Solid State Power Supply offers 85-90% efficiency compared to magnetic at 80%. The combination of 7 LEDs and a Solid State Power Supply increases the efficiency up to 22%.
- 50-watt power supply fits into J Box (PS-60L-ELV-24VDC)

SPECIFICATIONS

- 24VDC LED Soft Strip with 120 degree beam angle
- Available in 2.5, 4.4, 7.3, or 9.6 watts
- May be field-cut in 2.4 inch increments
- Sold in 1 foot long increments
- Class 2 Damp Listing; 100 watt limit per power supply

APPLICATIONS

- Indoor, damp, or dry locations
- Coves, toe-kicks, under cabinets and shelves, bookcases, drawers, pathways, accent lighting, task lighting, and general illumination

LAMP DATA:

- Average life is 50,000 hours
- Operating temperature: -22°F to 140°F (-30°C to 60°C)
- Includes a 5-year pro-rated warranty

INCLUDED COMPONENTS

- SS2C, SS5C, SS7C, or SS10C 24VDC LED Soft Strip
- Heat Sink Tape (SS7C & SS10C)
- 3M™ Adhesive Tape Backing

REQUIRED COMPONENTS (Sold Separately)

- Remote Power Supply
- Snap & Light Power Connector

ACCESSORIES (Sold Separately)

- 24VDC Solderless Snap & Light Jumper Connector
- Flexible Connectors
- Mounting Straps & Clips

REMOTE POWER SUPPLIES*, DIMMING & CONTROLS

(Sold Separately)

- Electronic Low Voltage Dimming (ELV)
- 0-10 Volt (0-10) Dimming
- Lutron Hi-Lume®

*In-Wall Mounting Kits available for select Power Supplies

MOUNTING

- Industrial 3M tape lines back of strip for self-adhesion to most smooth finished surfaces
- Additional Snap & Light Solderless Connectors, Mounting Straps, and Clips may be needed for some applications (sold separately)

SYSTEM	SS2C							SS5C							SS7C							SS10C						
WATTS PER FOOT	2.5W							4.4W							7.3W							9.6W						
COLOR TEMPERATURE	2200K	2400K	2700K	3000K	3500K	4000K	5700K	2200K	2400K	2700K	3000K	3500K	4000K	5700K	2200K	2400K	2700K	3000K	3500K	4000K	5700K	2200K	2400K	2700K	3000K	3500K	4000K	5700K
LUMENS PER FOOT	242	268	295	323	370	402	428	418	464	510	557	638	694	738	683	758	834	911	1043	1134	1207	885	983	1080	1180	1352	1470	1564
LUMENS PER WATT	97	107	118	129	148	161	171	95	105	115	126	145	157	167	94	104	114	125	143	155	165	92	102	112	123	140	153	163
CRI	85+	90+	95+	95+	85+	85+	85+	85+	90+	95+	95+	85+	85+	85+	85+	90+	95+	95+	85+	85+	85+	85+	90+	95+	95+	85+	85+	85+
Rf	83.9	85	87.7	88.1	86.1	87.6	80.3	83.9	85.2	87.7	88.1	86.1	87.6	80.3	83.9	85.2	87.7	88.1	86.1	87.6	80.3	83.9	85.2	87.7	88.1	86.1	87.6	80.3
RG	94.9	97.4	96.1	99.7	95.5	96.8	91.5	94.9	97.4	96.1	99.7	95.5	96.8	91.5	94.9	97.4	96.1	99.7	95.5	96.8	91.5	94.9	97.4	96.1	99.7	95.5	96.8	91.5
LEDS PER FOOT	35	35	35	35	35	35	35	35	35	35	35	35	35	35	35	35	35	35	35	35	35	35	35	35	35	35	35	35
MAX RUN LENGTH	40ft	40ft	40ft	40ft	40ft	40ft	40ft	20ft	20ft	20ft	20ft	20ft	20ft	20ft	12ft	12ft	12ft	12ft	12ft	12ft	12ft	10ft	10ft	10ft	10ft	10ft	10ft	10ft

ORDERING CODE

System	Voltage	Length in Feet	Color Temperature
SS2C	24V	40	27K
SS2C	24V 24 Volt	1-40 1 - 40 feet (SS2C)	22K 2200K Candle White
SS5C		1-20 1 - 20 feet (SS5C)	24K 2400K Very Warm White
SS7C		1-12 1 - 12 (SS7C)	27K 2700K Incandescent White
SS10C		1-10 1 - 10 feet (SS10C)	30K 3000K Warm White (Halogen)
			35K 3500K Neutral White
			40K 4000K Cool White
			57K 5700K Daylight White

PROJECT		FIXTURE TYPE		DATE	
---------	--	--------------	--	------	--

Indoor 24VDC LED Soft Strip: Accessories (sold separately)

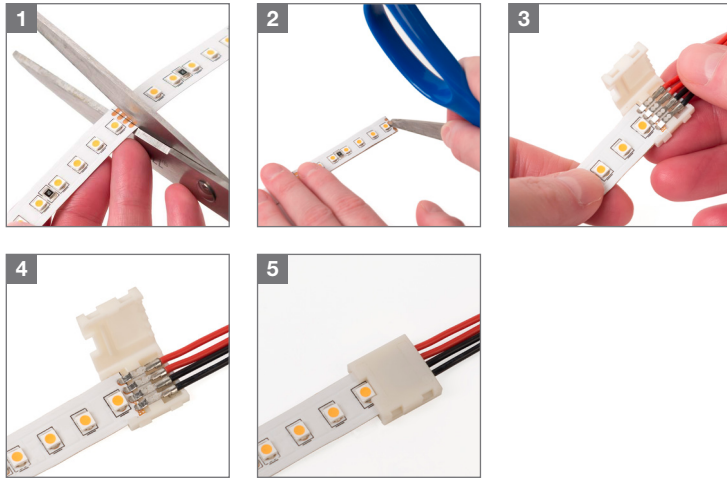

Using the Snap & Light Solderless Connectors: Cutting and reconnecting our LED Soft Strip is easy. All you need is a pair of scissors or any sharp device that will allow you to make a clean cut.

1. Cut or solder the middle of joining contacts
2. Remove the protective coating from the contacts
3. Place the LED Soft Strip end under the plastic guide and push it under the snap contacts
4. Close the cover
5. Snap the cover to secure in place

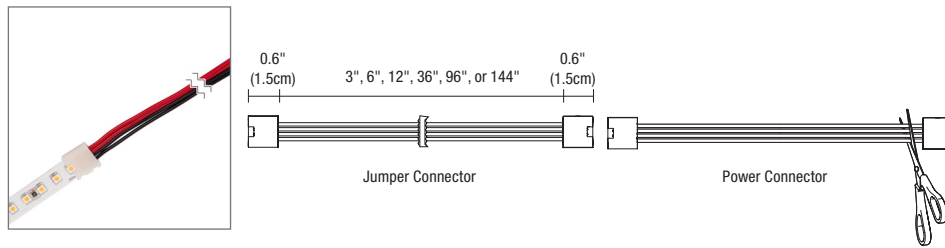

24VDC Solderless Snap & Light Power/Jumper Connector

Join 2 cut sections of LED Soft Strip end to end. Use as a power connector is required. Use as a jumper connector is optional. To use as a power connector cut and strip the wires.

Product	Type	Size
SS	SLC	12IN
SS LED Soft Strip	SLC Snap & Light Jumper or Power Connectors	
		3IN 3 inches 36IN 36 inches 6IN 6 inches 96IN 96 inches 12IN 12 inches 144IN 144 inches

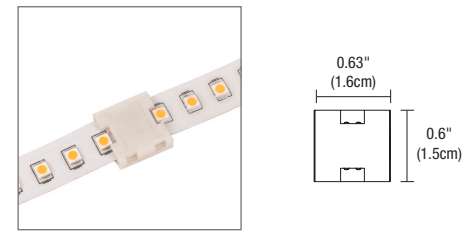

Solderless Snap & Light Straight Joiner

Join 2 cut sections of LED Soft Strip end to end.

Product	Type
SS	SLC
SS LED Soft Strip	SLC Snap & Light Straight Connector

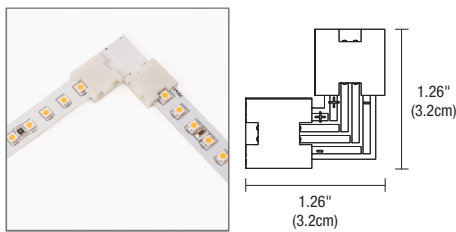

Solderless Snap & Light L-Connector

Join and conduct power to 2 sections of LED Soft Strip in an L-shape.

Product	Type
SS	SLL
SS LED Soft Strip	SLL Snap & Light L-Connector

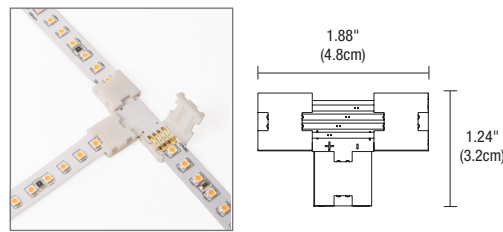

Solderless Snap & Light T-Connector

Join and conduct power to 3 sections of LED Soft Strip in a T-shape.

Product	Type
SS	SLT
SS LED Soft Strip	SLT Snap & Light T-Connector

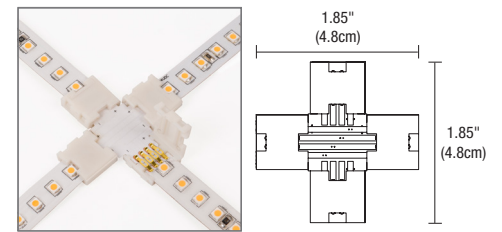

Solderless Snap & Light X-Connector

Join and conduct power to 4 sections of LED Soft Strip in an X-shape.

Product	Type
SS	SLX
SS LED Soft Strip	SLX Snap & Light X-Connector

PROJECT	FIXTURE TYPE	DATE
---------	--------------	------

Indoor & Outdoor 24VDC LED Soft Strip: Mounting Straps and Clips (sold separately)

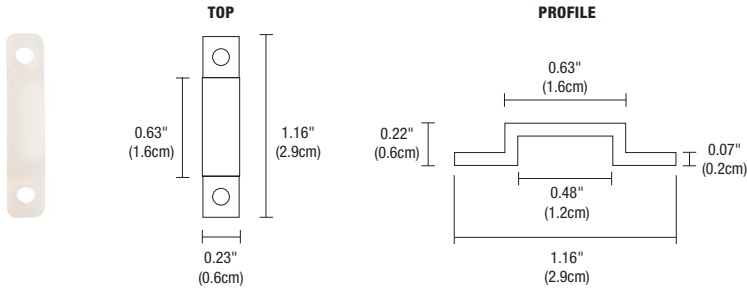

LED Soft Strip U-Strap

Use every 6 - 12 inches for extra support (30/package). Compatible with both Indoor and Outdoor LED Soft Strips. The U-Strap is included with Outdoor LED Soft Strips, and is ordered separately as a replacement part or for Indoor LED Soft Strips.

Product	Type
SS	SU
SS LED Soft Strip	SU U-Strap

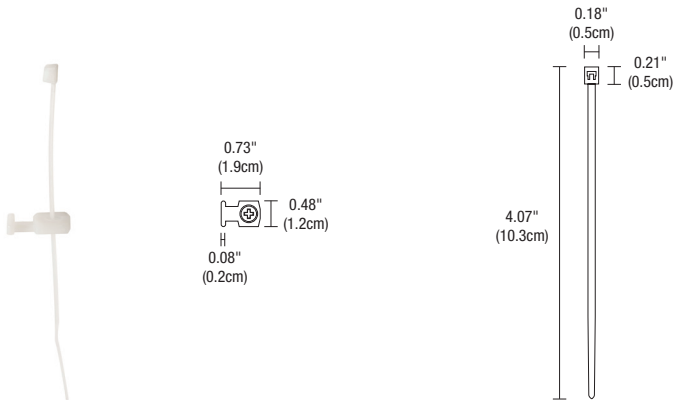

LED Soft Strip Tie Strap

Use every 6 - 12 inches for extra support (30/package). Compatible with both Indoor and Outdoor LED Soft Strips. The Tie Strap is included with Outdoor LED Soft Strips, and is ordered separately as a replacement part or for Indoor LED Soft Strips.

Product	Type
SS	ST
SS LED Soft Strip	ST Tie Strap

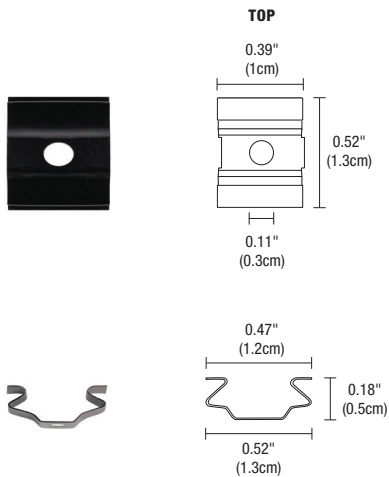

LED Soft Strip Screw-In Mounting Clip

Use Soft Strip Mounting Clip every 6 - 12 inches for extra support (10/package). Clip attaches to surface using screws and Strip snaps into clip.

Product	Type
SS	MCL
SS LED Soft Strip	MCL Mounting Clip

PROJECT	FIXTURE TYPE	DATE
---------	--------------	------

Power Consumption per Linear Foot: Maximum length before refeeding

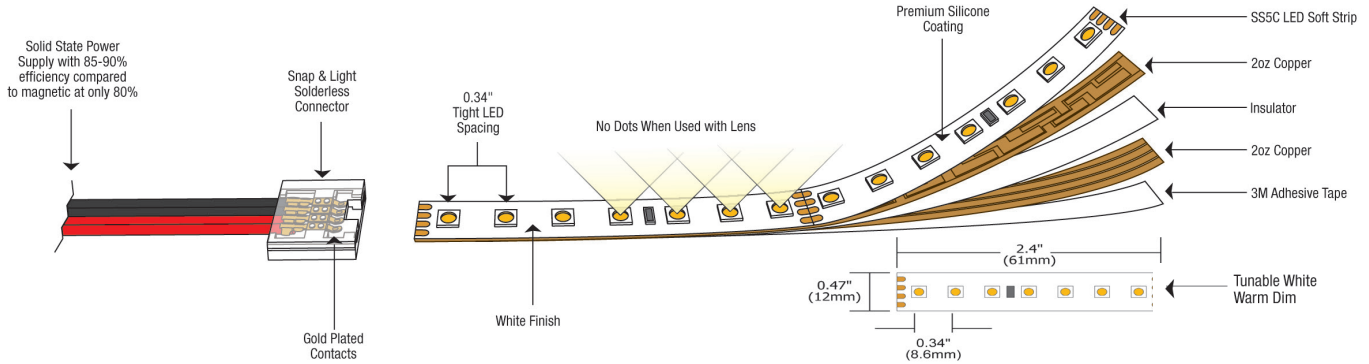

SS2C 24VDC LED SOFT STRIP (2.5 WATTS PER FOOT)																																
MAXIMUM LENGTH BEFORE REFEEDING: 40FT*																																
LENGTH IN FEET	1	2	3	4	5	6	7	8	9	10	11	12	13	14	15	16	17	18	19	20	21	22	23	24	25	26	27	28	29	30	31	32
TOTAL WATTAGE	3	6	9	12	15	18	21	24	27	30	33	36	39	42	45	48	51	54	57	60	63	66	69	72	75	78	81	84	87	90	93	96

*20 feet maximum with wet locations; 24 feet maximum when used with PSB-60W-ELV-24VDC

SS5C STATIC WHITE 24VDC LED SOFT STRIP (4.4 WATTS PER FOOT)																				
MAXIMUM LENGTH BEFORE REFEEDING: 20FT																				
LENGTH IN FEET	1	2	3	4	5	6	7	8	9	10	11	12	13	14	15	16	17	18	19	20
TOTAL WATTAGE	5	10	15	20	24	29	34	39	44	48	53	58	63	68	72	77	82	87	92	96

SS7C STATIC WHITE 24VDC LED SOFT STRIP (7.3 WATTS PER FOOT)												
MAXIMUM LENGTH BEFORE REFEEDING: 12FT												
LENGTH IN FEET	1	2	3	4	5	6	7	8	9	10	11	12
TOTAL WATTAGE	8	15	22	30	37	44	52	59	66	74	81	88

SS10C STATIC WHITE 24VDC LED SOFT STRIP (9.6 WATTS PER FOOT)										
MAXIMUM LENGTH BEFORE REFEEDING: 10FT										
LENGTH IN FEET	1	2	3	4	5	6	7	8	9	10
TOTAL WATTAGE	10	20	29	39	48	58	68	77	87	96

GRADE	LED SOFT STRIP	WATTAGE PER FOOT*	LUMENS PER WATT*	LEDS PER FOOT	APPLICATION
Commercial	SS2C	2.5W	129	35	Coves, Toe-Kicks, Under Cabinets, Shelves, Pathways, Low Level Ambient Light for Small Spaces
	SS5C	4.4W	126	35	Coves, Task Lighting, and General Illumination for Medium Spaces
	SS7C	7.3W	125	35	Coves, and General Illumination for Large Spaces
	SS10C	9.6W	123	35	Coves, and General Illumination for Very Large Spaces

* Lumen data reflects test results from the 3000K LED Soft Strip; other color temperatures may vary

PROJECT		FIXTURE TYPE		DATE	
---------	--	--------------	--	------	--



SS2C, SS5C, SS7C & SS10C COMMERCIAL STATIC WHITE SOFT STRIP

(2.5W, 5W, 7W, & 10W) 24VDC HIGH OUTPUT



DESIGNED BY GREGORY KAY | ASSEMBLED IN AMERICA

REV 03.16.20

Compatible Indoor Solid State Constant Voltage Power Supplies

UNIVERSAL POWER SUPPLIES & RECOMMENDED DIMMERS†				
ORDERING CODE	PSB-40W-UNI-24VDC	PSB-60W-UNI-24VDC	PSB-2X40W-UNI-24VDC	PSB-2X60W-UNI-24VDC
SPECIFICATIONS				
MAXIMUM LOAD	40W	60W	2X40W	2X60W
INPUT VOLTAGE	120-277VAC	120-277VAC	120-277VAC	120-277VAC
OUTPUT VOLTAGE	24VDC	24VDC	24VDC	24VDC
DIMENSIONS	12.4" X 3.12" X 2.18"	12.4" X 3.12" X 2.18"	12.15" X 6.48" X 2.18"	12.15" X 6.48" X 2.18"
CLASSIFICATION	CLASS 2	CLASS 2	CLASS 2	CLASS 2
IN-WALL MOUNTING	PSB-40W-UNI-24VDC-IW	PSB-60W-UNI-24VDC-IW	PSB-2X40W-UNI-24VDC-IW	PSB-2X60W-UNI-24VDC-IW
ELV DIMMING & CONTROLS				
LUTRON DIVA: DVELV-300P	•	•	•	•
LUTRON SKYLARK: SELV-300P	•	•	•	•
LUTRON RADIO RA2: RRD-6NA	•	•	•	•
LUTRON MAESTRO: MAELV-600	•	•	•	•
LEGRAND ADORNE: ADTP-703TUM4	•	•	•	•
0-10 DIMMING & CONTROLS				
PHILIPS SUNRISE: SR1200ZTUNV	•	•	•	•
LUTRON DIVA:: DVTV-WH	•	•	•	•
LUTRON NOVA T: NTSTV-DV-XX	•	•	•	•
LUTRON GRAFIX EYE QS: QSGRJ-XP	•	•	•	•
LUTRON RADIO RA2: RRD-10ND	•	•	•	•
LEVITON: LEV40050	•	•	•	•
LEVITON IP710-LFZ	•	•	•	•
LEGRAND: ADPD4FBL3P2W4	•	•	•	•
UNIVERSAL POWER SUPPLIES & RECOMMENDED DIMMERS†				
ORDERING CODE	PSB-96W-UNI-24VDC	PSB-2X96W-UNI-24VDC	PSB-3X96W-UNI-24VDC	PSB-4X96W-UNI-24VDC
SPECIFICATIONS				
MAXIMUM LOAD	96W	2X96W	3X96W	4X96W
INPUT VOLTAGE	120-277VAC	120-277VAC	120-277VAC	120-277VAC
OUTPUT VOLTAGE	24VDC	24VDC	24VDC	24VDC
DIMENSIONS	12.4" X 3.12" X 2.18"	12.15" X 6.48" X 2.18"	14" X 10" X 3"	17" X 13" X 3"
CLASSIFICATION	CLASS 2	CLASS 2	CLASS 2	CLASS 2
IN-WALL MOUNTING	PSB-96W-UNI-24VDC-IW	PSB-2X96W-UNI-24VDC-IW	PSB-3X96W-UNI-24VDC-IW	PSB-4X96W-UNI-24VDC-IW
ELV DIMMING & CONTROLS				
LUTRON DIVA: DVELV-300P	•	•	•	•
LUTRON SKYLARK: SELV-300P	•	•	•	•
LUTRON RADIO RA2: RRD-6NA	•	•	•	•
LUTRON MAESTRO: MAELV-600	•	•	•	•
LEGRAND ADORNE: ADTP-703TUM4	•	•	•	•
0-10 DIMMING & CONTROLS				
PHILIPS SUNRISE: SR1200ZTUNV	•	•	•	•
LUTRON DIVA:: DVTV-WH	•	•	•	•
LUTRON NOVA T: NTSTV-DV-XX	•	•	•	•
LUTRON GRAFIX EYE QS: QSGRJ-XP	•	•	•	•
LUTRON RADIO RA2: RRD-10ND	•	•	•	•
LEVITON: LEV40050	•	•	•	•
LEVITON IP710-LFZ	•	•	•	•
LEGRAND: ADPD4FBL3P2W4	•	•	•	•

† 2200K-5700K Color Temperatures are compatible with 0-10V, ELV, and Lutron Hi-Lume® Power Supplies. Warm Dim (27D, 30D) Color Temperatures are only compatible with ELV Power Supplies.
In-Wall Mounting Kits available for select power supplies.

The Solid State Constant Voltage Uni-Power Supply is compatible with most commercially available Dimmers:
 Triac Dimmer : (Forward Phase) Typically used for the dimming of Incandescent and Low Voltage Magnetic Transformers
 ELV Dimmer : (Reverse Phase) Dimming of Electronic Low Voltage Transformers and Power Supply's used for LED lighting
 0-10 Dimmer : Dims the Low Voltage side of a 0-10 volt power supply commonly used in large scale lighting or commercial applications.

The Uni-Power Supply is NOT compatible with Pure Edge Warm Dim Soft Strip. Please use Pure Edge 0-10 Volt or Pure Edge ELV power supplies for that application.

The Uni-Power Supply is recommended with any Siemens/Murray brand of arc fault breaker to overcome the issues with tripping the breakers with an ELV LED Low Voltage Drivers.

PROJECT		FIXTURE TYPE		DATE	
---------	--	--------------	--	------	--



SS2C, SS5C, SS7C & SS10C COMMERCIAL STATIC WHITE SOFT STRIP

(2.5W, 5W, 7W, & 10W) 24VDC HIGH OUTPUT



DESIGNED BY GREGORY KAY | ASSEMBLED IN AMERICA

REV 03.16.20

Compatible Indoor 24VDC ELV Power Supplies: Indoor 24VDC LED Soft Strip

ELECTRONIC LOW-VOLTAGE (ELV) POWER SUPPLIES & RECOMMENDED DIMMERS†				
ORDERING CODES	PS-60L-ELV-24VDC	PSB-60W-ELV-24VDC	PSB-2X60W-ELV-24VDC	PSB-100W-ELV-24VDC
SPECIFICATIONS				
MAXIMUM LOAD	60W-NON IC, 50W-IC (FITS IN JBOX)	60W	2X60W	96W
INPUT VOLTAGE	120VAC	120VAC	120VAC	120VAC
OUTPUT VOLTAGE	24VDC	24VDC	24VDC	24VDC
DIMENSIONS	2.25" X 1.25" X 0.83"	8.125" X 2" X 1.75"	12.15" X 6.48" X 2.18"	9.25" X 3.5" X 2"
CLASSIFICATION	CLASS 2	CLASS 2	CLASS 2	CLASS 2
IN WALL MOUNTING	N/A	PSB-60W-ELV-24VDC-IW	PSB-2X60W-ELV-24VDC-IW	PSB-100W-ELV-24VDC-IW
DIMMING AND CONTROLS				
LUTRON DIVA: DVELV-300P	•	•	•	•
LUTRON SKYLARK: SELV-300P	•	•	•	•
LUTRON RADIO RA2: RRD-6NA	N/A	•	•	•
LUTRON MAESTRO: MAELV-600	•	•	•	•
LEGRAND ADORNE: ADTP-703TUM4	N/A	•	•	•

ELECTRONIC LOW-VOLTAGE (ELV) POWER SUPPLIES & RECOMMENDED DIMMERS†			
ORDERING CODES	PSB-2X100W-ELV-24VDC	PSB-3X100W-ELV-24VDC	PSB-4X100W-ELV-24VDC
SPECIFICATIONS			
MAXIMUM LOAD	2X96W	3X96W	4X96W
INPUT VOLTAGE	120VAC	120VAC	120VAC
OUTPUT VOLTAGE	24VDC	24VDC	24VDC
DIMENSIONS	12.15" X 6.48" X 2.18"	14" X 10" X 3"	17" X 13" X 3"
CLASSIFICATION	CLASS 2	CLASS 2	CLASS 2
IN WALL MOUNTING	PSB-2X100W-ELV-24VDC-IW	N/A	N/A
DIMMING AND CONTROLS			
LUTRON DIVA: DVELV-300P	•	•	•
LUTRON SKYLARK: SELV-300P	•	•	•
LUTRON RADIO RA2: RRD-6NA	•	•	•
LUTRON MAESTRO: MAELV-600	•	•	•
LEGRAND ADORNE: ADTP-703TUM4	•	•	•

†2400K-5700K Color Temperatures are compatible with 0-10V, ELV, and Lutron Hi-lume® Power Supplies. Warm Dim (27D, 30D) Color Temperatures are only compatible with ELV Power Supplies.

*Electrical Panels using Siemens/Murray AFCI breakers are not compatible with this ELV transformer. Use 0-10 Volt power supply's with this breaker.

Classification: UL2108 - * 24VDC over 100 Watts, wires must be in conduit from Remote Power Supply to Junction Box in ceiling.

With N-Lite Dimming Do Not use ELV power supply's, use only 0-10 volt or Uni drivers power supplies

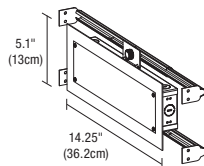

5.1 x 14.25 inch In-Wall Mounting Kit: Includes power supply, box covers, and stud hangers for installing Junction Box in wall. Select "IW" in the options section of compatible power supply ordering codes if an In-Wall Mounting Kit is needed.

Ordering Codes: PSB-60W-ELV-24VDC-IW, PSB-100W-ELV-24VDC-IW

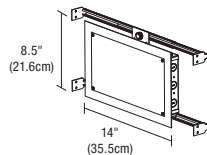

8.5 x 14 inch In-Wall Mounting Kit: Includes power supply, box covers, and stud hangers for installing Junction Box in wall. Select "IW" in the options section of compatible power supply ordering codes if an In-Wall Mounting Kit is needed.

Ordering Codes: PSB-2x60W-ELV-24VDC-IW, PSB-2x100W-ELV-24VDC-IW

PROJECT	FIXTURE TYPE	DATE
---------	--------------	------



SS2C, SS5C, SS7C & SS10C COMMERCIAL STATIC WHITE SOFT STRIP

(2.5W, 5W, 7W, & 10W) 24VDC HIGH OUTPUT



DESIGNED BY GREGORY KAY | ASSEMBLED IN AMERICA

REV 03.16.20

Compatible Indoor 24VDC 0-10 Power Supplies: Indoor 24VDC LED Soft Strip

0-10 VOLT (010) POWER SUPPLIES & RECOMMENDED DIMMERS†				
ORDERING CODES	PSB-25W-010-24VDC	PSB-60W-010-24VDC	PSB-96W-010-24VDC	PSB-2X96W-010-24VDC
SPECIFICATIONS				
MAXIMUM LOAD	25W	60W	96W	2X96W
INPUT VOLTAGE	120VAC	120-277VAC	120-277VAC	120-277VAC
OUTPUT VOLTAGE	24VDC	24VDC	24VDC	24VDC
DIMENSIONS	12.4" X 3.12" X 2.18"	12.4" X 3.12" X 2.18"	12.4" X 3.12" X 2.18"	12.15" X 6.48" X 2.18"
CLASSIFICATION	CLASS 2	CLASS 2	CLASS 2	CLASS 2
IN WALL MOUNTING	PSB-25W-010-24VDC-IW	PSB-60W-010-24VDC-IW	PSB-96W-010-24VDC-IW	PSB-2X96W-010-24VDC-IW
DIMMING AND CONTROLS				
PHILIPS SUNRISE: SR1200ZTUNV	•	•	•	•
LUTRON DIVA: DVTV-WH	•	•	•	•
LUTRON NOVA T: NTSTV-DV-XX	•	•	•	•
LUTRON GRAFIX EYE QS: QSGRJ-XP	•	•	•	•
LUTRON RADIO RA2: RRD-10ND	•	•	•	•
LEVITON: LEV40050	•	•	•	•
LEVITON IP710-LFZ	•	•	•	•
LEGRAND: ADPD4FBL3P3W4	•	•	•	•

0-10 VOLT (010) POWER SUPPLIES & RECOMMENDED DIMMERS†		
ORDERING CODES	PSB-3X96W-010-24VDC	PSB-4X96W-010-24VDC
SPECIFICATIONS		
MAXIMUM LOAD	3X96W	4X96W
INPUT VOLTAGE	120-277VAC	120-277VAC
OUTPUT VOLTAGE	24VDC	24VDC
DIMENSIONS	14" X 10" X 3"	17" X 13" X 3"
CLASSIFICATION	CLASS 2	CLASS 2
IN WALL MOUNTING	N/A	N/A
DIMMING AND CONTROLS		
PHILIPS SUNRISE: SR1200ZTUNV	•	•
LUTRON DIVA: DVTV-WH	•	•
LUTRON NOVA T: NTSTV-DV-XX	•	•
LUTRON GRAFIX EYE QS: QSGRJ-XP	•	•
LUTRON RADIO RA2: RRD-10ND	•	•
LEVITON: LEV40050	•	•
LEVITON IP710-LFZ	•	•
LEGRAND: ADPD4FBL3P3W4	•	•

†2200K-5700K Color Temperatures are compatible with 0-10V, ELV, and Lutron Hi-lume® Power Supplies. Warm Dim (27D, 30D) Color Temperatures are only compatible with ELV Power Supplies.

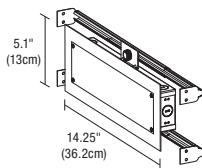

5.1 x 14.25 inch In-Wall Mounting Kit: Includes power supply, box covers, and stud hangers for installing Junction Box in wall. Select "IW" in the options section of compatible power supply ordering codes if an In-Wall Mounting Kit is needed.

Ordering Codes: PSB-25W-010-24VDC-IW, PSB-60W-010-24VDC-IW, PSB-96W-010-24VDC-IW

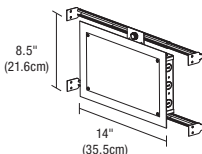

8.5 x 14 inch In-Wall Mounting Kit: Includes power supply, box covers, and stud hangers for installing Junction Box in wall. Select "IW" in the options section of compatible power supply ordering codes if an In-Wall Mounting Kit is needed.

Ordering Codes: PSB-2X96W-010-24VDC-IW

PROJECT	FIXTURE TYPE	DATE
---------	--------------	------



SS2C, SS5C, SS7C & SS10C COMMERCIAL STATIC WHITE SOFT STRIP

(2.5W, 5W, 7W, & 10W) 24VDC HIGH OUTPUT



DESIGNED BY GREGORY KAY | ASSEMBLED IN AMERICA

REV 03.16.20

Compatible Indoor 24VDC Lutron Hi-Lume® Power Supplies: Indoor 24VDC LED Soft Strip

LUTRON HI-LUME® PREMIER .1% ECOSYSTEM® 3-WIRE POWER SUPPLY & RECOMMENDED CONTROLLERS†	
ORDERING CODES	L3D0-96W24V-U 
SPECIFICATIONS	
MAXIMUM LOAD	96W
INPUT VOLTAGE	120-277VAC
OUTPUT VOLTAGE	24VDC
DIMENSIONS	10.5" X 5.5" X 2"
CLASSIFICATION	CLASS 2
DIMMING AND CONTROLS	
RADIO RA2	•
HOMEWORKS QS	•
PHPM-3F-120	•
PHPM-3F-DV	•
BCI-0-10	•

†2200K-5700K Color Temperatures are compatible with 0-10V, ELV, and Lutron Hi-lume® Power Supplies. Warm Dim (27D, 30D) Color Temperatures are only compatible with ELV Power Supplies.

PROJECT		FIXTURE TYPE		DATE	
---------	--	--------------	--	------	--

Indoor Electronic Low Voltage Dimming (ELV) Sample Wiring Diagram: The example below is using a Class 2, 24VDC 60 watts ELV Power Supply with 60 watts output. Dimming is possible but not recommended for Static White LED Soft Strips. See the Power Supply comparison chart for other compatible ELV Power Supply and dimmer options.

INDOOR ELECTRONIC LOW VOLTAGE DIMMING (ELV)

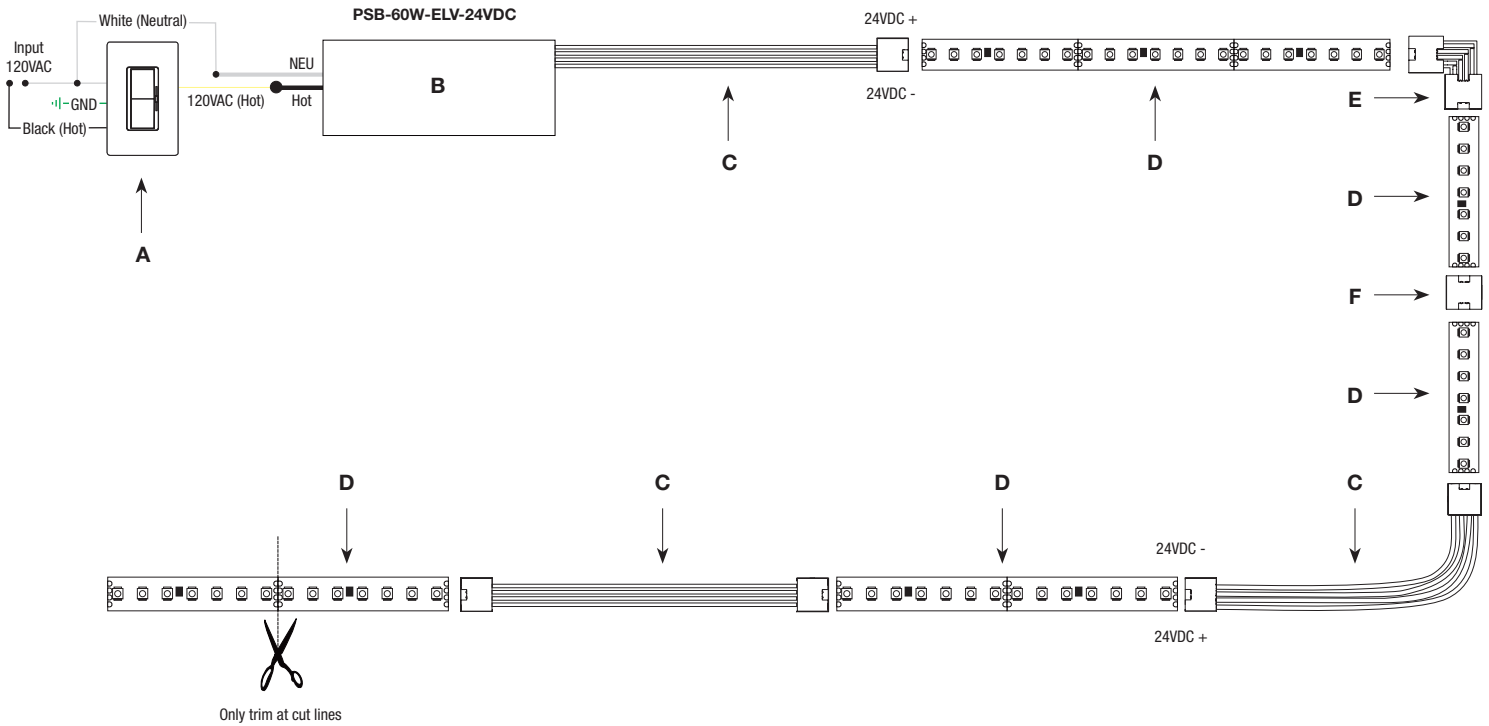

- A. ELV Dimmer
- B. ELV Power Supply
- C. 24VDC Solderless Snap & Light Power/Jumper Connector
- D. 24VDC LED Soft Strip Commercial, Static White
- E. Solderless Snap & Light L-Connector
- F. Solderless Snap & Light Straight Joiner

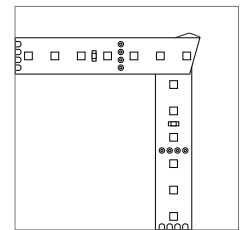

LED Soft Strip does **NOT** bend 90°

PROJECT	FIXTURE TYPE	DATE
---------	--------------	------



SS2C, SS5C, SS7C & SS10C COMMERCIAL STATIC WHITE SOFT STRIP (2.5W, 5W, 7W, & 10W) 24VDC HIGH OUTPUT



DESIGNED BY GREGORY KAY | ASSEMBLED IN AMERICA

REV 03.16.20

Indoor 0-10 Volt Dimming (0-10V) Sample Wiring Diagram: The example below is using a Class 2, 24VDC 96 watts 0-10V Power Supply with 120 - 277 VAC input, and 24VDC 96 watts output. Dimming is possible but not recommended for Static White LED Soft Strips. See the Power Supply comparison chart for other compatible 0-10V Power Supply and dimmer options.

INDOOR 0-10 VOLT DIMMING (0-10V)

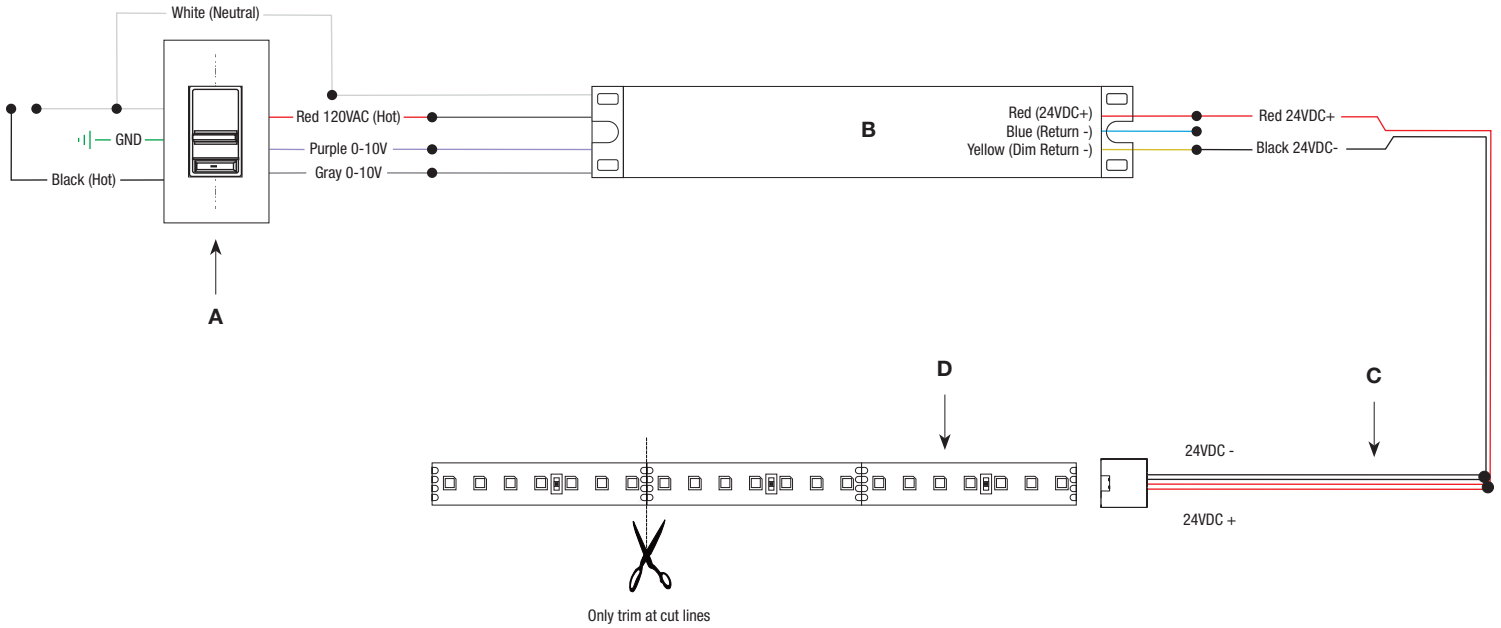

- A. 0-10V Dimmer
- B. 0-10V Power Supply
- C. 24VDC Solderless Snap & Light Power/Jumper Connector
- D. 24VDC LED Soft Strip Commercial, Static White

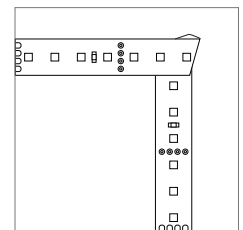

LED Soft Strip does **NOT** bend 90°

PROJECT	FIXTURE TYPE	DATE
---------	--------------	------



SS2C, SS5C, SS7C & SS10C COMMERCIAL STATIC WHITE SOFT STRIP

(2.5W, 5W, 7W, & 10W) 24VDC HIGH OUTPUT



DESIGNED BY GREGORY KAY | ASSEMBLED IN AMERICA

REV 03.16.20

Indoor 24VDC LED Soft Strip Compatible Channels: 24VDC LED Soft Strips can be installed as a single strip or installed within a compatible channel with lens. See Light Channel spec sheets at EdgeLighting.com and TruLine, Reveal and Reveal Wall Wash spec sheets at PureLighting.com for more information.

- C Clear Lens
 D Diffuser Lens
 F Frosted Lens
 L Linear Frost Lens
 G Gel Color Filter Suitable
 W Wet Location*

*Wet location options are only available for complete fixtures

SURFACE MOUNT LIGHT CHANNELS: Recommended applications* — Cove, pathway, toe-kick, undercabinet, and shelves

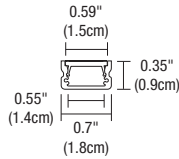

LCS.3 Light Channel

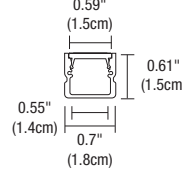

LCS.6 Light Channel

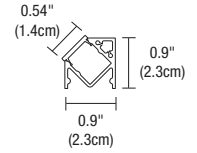

LC45 Light Channel 45°

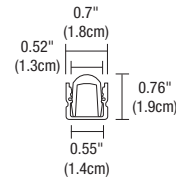
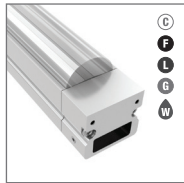

LCMG Light Channel Micro Grazer

RECESSED LIGHT CHANNELS: Recommended applications* (Recessed into drywall or wood)** — Coves, pathways, toe-kicks, undercabinets, and shelves

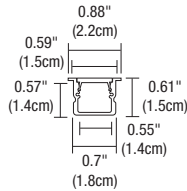

LCMW.6 Light Channel Millwork

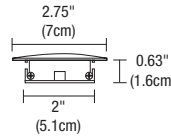

LCT1.6 Light Channel Trim

RECESSED CHANNELS: Recommended applications* (Recessed into 5/8 inch or thicker drywall)** — General illumination, architectural accents, coves, toe-kicks, and wall wash

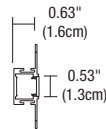

TL5A TruLine .5A

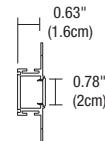

TL1A TruLine 1A

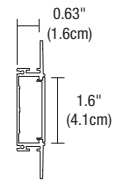

TL1.6A TruLine 1.6A

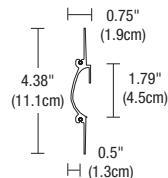

RV Reveal

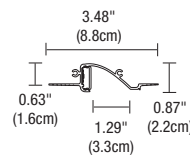

RVWW Reveal Wall Wash

PRODUCT	LCS.3	LCS.6	LC45	LCMG	XXX	LCMW.6	LCT1.6	TL5A	TL1A	TL1.6A	RV	RVWW
DIY (Do-It-Yourself)	X	X	X	X	X	X	N/A	N/A	N/A	N/A	N/A	N/A
Complete Fixture	X	X	X	X	N/A	X	X	X	X	X	X	X
BIY (Build-It-Yourself)	N/A	N/A	N/A	N/A	N/A	N/A	N/A	X	X	X	X	X
SS2C Static White	X	X	X	N/A	X	X	X	X	X	X	X	N/A
SS5C Static White	X	X	X	X	X	X	X	X	X	X	X	X
SS7C Static White	X	X	X	X	X	X	X	X	X	X	X	X
SS10C Static White	X	X	X	X	X	X	X	X	X	X	X	X

*Applications may vary by product. See individual product spec sheets for specific applications.

**Light Channel Millwork recesses into 3/4 inches thick wood; Light Channel trim recesses into 5/8 inch drywall or wood; and Reveal recesses into 1/2 inch or thicker drywall

PROJECT		FIXTURE TYPE		DATE	
---------	--	--------------	--	------	--

TM-30-15 Data: Consistent color temperatures throughout a single strip and among multiple strips is possible through a 3 phase binning process where each order is inspected with a color meter to ensure uniformity.

2200K | Rf: 83.9 | Rg: 94.9

Color Vector Graphic

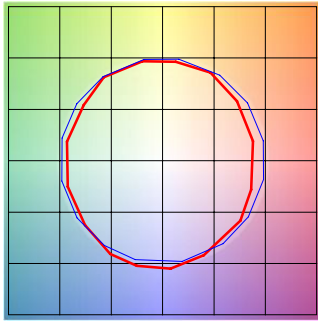

■ Test ■ Reference

HUE BIN	Rf	GRAPHIC SHIFTS %	
		CHROMA	HUE
1	77.6	-10.0%	1.8%
2	80.7	-7.5%	7.0%
3	79.5	-2.9%	8.9%
4	90.5	-3.1%	2.4%
5	93.9	-1.3%	1.9%
6	91.9	-0.9%	-0.2%
7	87.6	-6.3%	-2.7%
8	90.5	-5.4%	2.7%
9	83.8	-4.7%	6.5%
10	81.2	-2.5%	10.0%
11	83.3	3.9%	9.4%
12	86.4	5.6%	2.6%
13	86.2	4.5%	-12.4%
14	64.3	-1.0%	-21.9%
15	85.1	-4.4%	-7.5%
16	75.0	-9.9%	-12.0%

2400K | Rf: 84.5 | Rg: 94.4

Color Vector Graphic

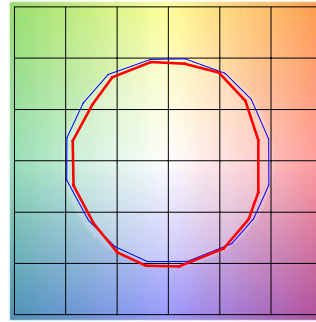

■ Test ■ Reference

HUE BIN	Rf	GRAPHIC SHIFTS %	
		CHROMA	HUE
1	81.1	-7.7%	3.0%
2	84.9	-5.7%	4.9%
3	85.3	-2.3%	6.1%
4	87.7	-5.5%	-0.5%
5	92.5	-3.9%	0.5%
6	91.1	-3.4%	0.1%
7	86.0	-7.7%	0.5%
8	87.1	-6.0%	4.3%
9	80.1	-3.9%	9.8%
10	79.0	-0.9%	11.8%
11	82.3	5.5%	10.1%
12	87.6	5.4%	-0.5%
13	84.7	3.3%	-12.0%
14	78.0	0.8%	-13.7%
15	86.9	-5.5%	-4.3%
16	78.1	-7.5%	-10.8%

2700K | Rf: 87.7 | Rg: 96.1

Color Vector Graphic

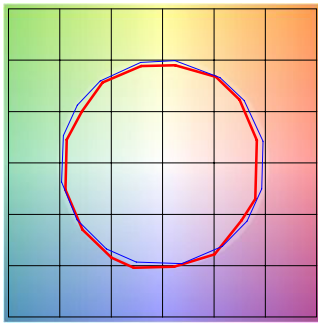

■ Test ■ Reference

HUE BIN	Rf	GRAPHIC SHIFTS %	
		CHROMA	HUE
1	86.4	-5.6%	2.3%
2	89.7	-3.3%	3.1%
3	90.5	-1.5%	3.8%
4	90.0	-4.3%	1.1%
5	92.9	-3.7%	0.2%
6	93.5	-2.5%	-0.8%
7	86.3	-7.2%	2.5%
8	90.7	-4.0%	3.2%
9	85.2	-2.4%	8.1%
10	81.7	0.9%	10.8%
11	85.4	4.5%	8.9%
12	88.7	5.7%	-1.4%
13	88.3	1.3%	-7.9%
14	85.1	2.4%	-10.4%
15	88.1	-4.8%	-2.7%
16	81.7	-4.3%	-10.9%

3000K | Rf: 88.1 | Rg: 99.7

Color Vector Graphic

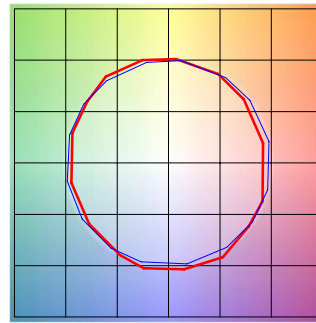

■ Test ■ Reference

HUE BIN	Rf	GRAPHIC SHIFTS %	
		CHROMA	HUE
1	87.7	-5.9%	-0.3%
2	87.9	-4.4%	4.3%
3	82.9	-1.2%	7.9%
4	89.9	0.6%	4.7%
5	92.7	3.0%	3.5%
6	92.7	3.6%	-1.7%
7	90.8	-1.3%	-4.4%
8	93.7	-2.5%	-2.2%
9	91.7	-3.7%	2.3%
10	85.5	-2.8%	7.8%
11	83.3	0.7%	11.0%
12	86.4	5.5%	3.8%
13	90.6	4.6%	-3.6%
14	85.6	5.9%	-8.4%
15	89.5	-0.6%	-5.7%
16	82.6	-2.7%	-12.0%

3500K | Rf: 86.1 | Rg: 95.5

Color Vector Graphic

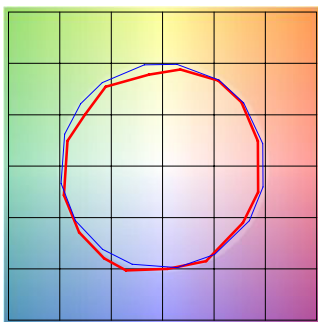

■ Test ■ Reference

HUE BIN	Rf	GRAPHIC SHIFTS %	
		CHROMA	HUE
1	86.6	-4.2%	3.4%
2	91.7	-1.4%	1.8%
3	94.9	-0.7%	0.4%
4	87.9	-4.5%	-4.1%
5	85.9	-10.3%	-2.7%
6	89.8	-5.2%	-0.4%
7	79.6	-9.5%	6.5%
8	87.6	-4.0%	5.7%
9	81.4	-0.5%	11.8%
10	78.3	3.3%	11.4%
11	85.7	6.3%	6.1%
12	86.3	7.1%	-4.6%
13	86.1	-0.7%	-9.6%
14	85.1	0.8%	-10.4%
15	83.4	-4.1%	-5.3%
16	82.5	-3.6%	-5.7%

4000K | Rf: 87.6 | Rg: 96.8

Color Vector Graphic

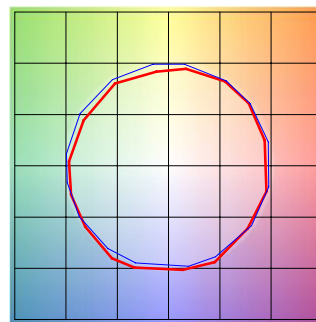

■ Test ■ Reference

HUE BIN	Rf	GRAPHIC SHIFTS %	
		CHROMA	HUE
1	89.0	-3.1%	2.1%
2	93.2	-0.9%	1.3%
3	94.3	-1.1%	0.7%
4	89.5	-4.0%	-2.3%
5	87.6	-7.8%	-1.8%
6	92.2	-4.6%	0.1%
7	87.4	-6.6%	3.6%
8	85.7	-3.8%	7.0%
9	81.5	-1.3%	12.4%
10	80.0	0.9%	11.4%
11	83.3	5.9%	8.7%
12	89.7	4.8%	-0.3%
13	88.5	2.4%	-6.3%
14	92.7	4.0%	-3.8%
15	86.1	-1.6%	-4.5%
16	85.0	-1.4%	-5.0%

PROJECT	FIXTURE TYPE	DATE
---------	--------------	------



SS2C, SS5C, SS7C & SS10C COMMERCIAL STATIC WHITE SOFT STRIP

(2.5W, 5W, 7W, & 10W) 24VDC HIGH OUTPUT



DESIGNED BY GREGORY KAY | ASSEMBLED IN AMERICA

REV 03.16.20

TM-30-15 Data: Consistent color temperatures throughout a single strip and among multiple strips is possible through a 3 phase binning process where each order is inspected with a color meter to ensure uniformity.

5700K | Rf: 80.3 | Rg: 91.5

Color Vector Graphic

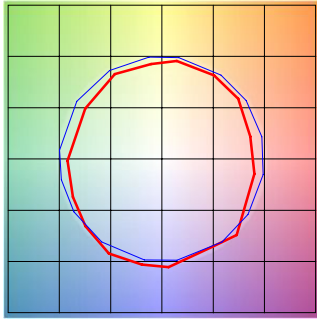

■ Test ■ Reference

		GRAPHIC SHIFTS %	
HUE BIN	Rf	CHROMA	HUE
1	73.8	-11.2%	2.6%
2	83.7	-5.5%	5.8%
3	84.2	-4.0%	5.5%
4	85.8	-3.5%	1.3%
5	85.3	-7.1%	0.6%
6	89.2	-5.8%	-2.2%
7	81.5	-10.7%	1.2%
8	75.7	-9.7%	8.5%
9	74.9	-7.8%	18.8%
10	67.8	-1.6%	18.0%
11	76.1	5.5%	12.0%
12	90.8	4.9%	-1.6%
13	83.6	5.0%	-9.5%
14	81.7	-1.2%	-10.0%
15	69.0	2.0%	-22.8%
16	83.2	-8.5%	-1.0%

PROJECT		FIXTURE TYPE		DATE	
---------	--	--------------	--	------	--