

PIPELINE® 2 WALL/VANITY
24VDC END FEED VANITY WITH WARM DIM AND STATIC WHITE

DESIGNED BY GREGORY KAY | MADE IN AMERICA

REV 09.24.20

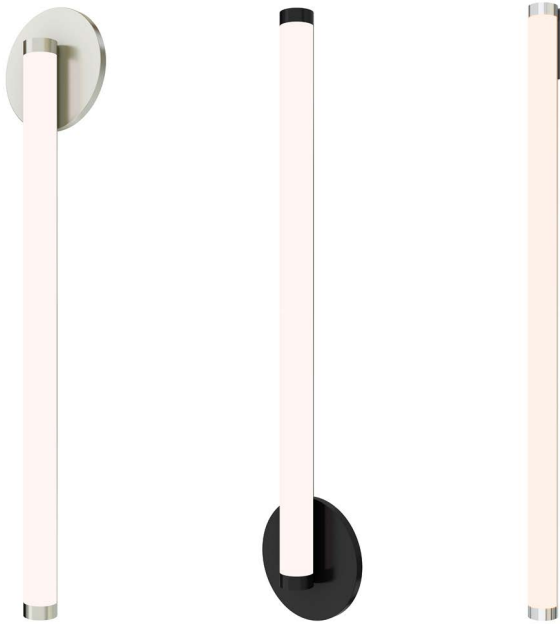

DESCRIPTION

Pipeline 2 Wall/Vanity with End Feed is a slender yet powerful linear LED with multiple finish and hardware options making it the perfect fixture for almost any environment including minimal and transitional spaces. Choose from nine standard Color Temperatures ranging between 2200K to 5700K, including two Warm Dim options of 2700K (27D) or 3000K (30D) that dim down to 2000K. The 280° diffused white lens provides clean, uninterrupted illumination in all directions and is available in many standard incremental lengths up to 120". The Pipeline 2 vanity is offered with two types of power options; P2WDP has an electronic low voltage (ELV) power supply that fits inside junction box and is included, P2WDR has a Remote Universal Power Supply (Sold Separately). Available in four fine metal finishes with multiple mounting and hardware options.

SPECIFICATIONS

P2WDP - 24VDC includes an electronic low voltage (ELV) power supply that fits within the junction box. 7W up to 72" length max.

P2WDR - 24VDC Remote, Class 2 power supply (Sold Separately)

Power Consumed - 5 or 7 Watts per Foot

Performance - Up to 986 Lumens per foot

30 years of precision lighting manufacturing and design

MOUNTING OPTIONS

- **E1R** - Reveals only the slightest outline of the canopy that mounts to a Slim Profile junction box (included) recommended for new construction application
- **E1R2** - The same as E1R, and includes a second blank matching canopy, for a symmetrical look
- **E4R** - Round 4.6" Canopy mounts to a standard 4" junction box
- **E4R2** - The same as E4R, and includes a blank matching canopy, for a symmetrical look

FINISHES



Satin Black **BK** Chrome **CH** Satin Nickel **SN** White **WH**

ORDERING

- Ordering refers to Lens Lengths- see page 2 for Overall Fixture Dimensions
- Refer to our Price List for All Standard Length Options 9"-120"
- Custom Lengths Available

LENS

- Diffused White 280° Lens, 174° beam angle

LAMPING

- Static White color temperatures from 2200K-5700K
- Warm Dim: 2700K (27D) and 3000K (30D) that dim down to 2000K (5W Only)
- Designer-grade Color Rendering 95+CRI
- 50,000 Hour Lamp Life

REMOTE POWER SUPPLIES*, DIMMERS & CONTROLS (SOLD SEPARATELY)

- Uni-Drive: Universal Dimming (TRIAC, ELV, 0-10V)
- Electronic Low Voltage dimming (ELV)
- Lutron Hi-Lume®

*In-Wall Mounting Kits available for select power supplies

APPLICATIONS

Designed for Indoor and Damp Locations - Ideal applications in Residential, Commercial, and Hospitality Environments, including Bathroom Vanities, Resort Spas, Health Clubs, and Hotels

COMPLIANCE/WARRANTY

5 year pro-rated warranty. Damp Location, ETL Listed, Class 2 wiring, Title 24, Made in America

CONFIGURATOR

Use our Configurator to see List Price, Complete Ordering Code and Overall Length. [Pipeline 2 Wall Vanity Configurator](#)

PROJECT	FIXTURE TYPE	DATE
---------	--------------	------

PIPELINE® 2 WALL/VANITY

24VDC END FEED VANITY WITH WARM DIM AND STATIC WHITE

System	Wattage	Canopy Type	Lens Length (Inches)	Color Temperature	Finish
P2WDP	5W	E4R	24	30K	SN
<p>P2WDP Pipeline 2 Wall Vanity with ELV Power Supply in Junction Box*</p> <p>P2WDR Pipeline 2 Wall Vanity with Remote Power Supply, 24VDC Class 2 Power, Title 24**</p> <p>*7W Maximum Length is 72" for P2WDP</p> <p>**Refer to pages 4-6 for Remote Power Supply options. Universal Power Supplies are Title 24 Compliant.</p>	<p>5W 5 Watts</p> <p>7W 7.3 Watts</p>	<p>E1R 1" Rectangular Slim Profile J-Box and canopy</p> <p>E4R End Feed, 4.6" Round Canopy</p> <p>E1R2 Two 1" Rectangular Canopies at each end, one is blank. Slim Profile J-Box.</p> <p>E4R2 Two 4.6" Canopies at each end, one is blank</p>	<p>STATIC WHITE*</p> <p>12, 15, 17, 20, 22, 24, 27, 29, 32, 34, 36, 39, 41, 44, 46, 48, 51, 53, 56, 58, 60, 63, 65, 68, 70, 72, 75, 77, 80, 82, 84, 87, 89, 92, 94, 96, 98, 99, 101, 104, 106, 108, 111, 113, 116, 118, 120</p> <p>WARM DIM*</p> <p>9, 12, 15, 18, 21, 24, 27, 30, 33, 36, 39, 42, 45, 48, 51, 54, 57, 60, 63, 66, 69, 72, 75, 78, 81, 84, 87, 90, 93, 96, 99, 102, 105, 108, 111, 114, 117, 120</p> <p>*84" Maximum length for Chrome</p>	<p>22K 2200K Amber White</p> <p>24K 2400K Very Warm White</p> <p>27K 2700K Incandescent White</p> <p>27D 2700K Warm Dim to 2000K (5W Only)</p> <p>30K 3000K Warm White</p> <p>30D 3000K Warm Dim to 2000K (5W Only)</p> <p>35K 3500K Neutral White</p> <p>40K 4000K Cool White</p> <p>57K 5700K Daylight White</p>	<p>BK Black</p> <p>CH Chrome</p> <p>SN Satin Nickel</p> <p>WH White</p>

LENGTH CHART Actual Lengths for Pipeline 2 Wall Vanity - End Feed (Inches)

STATIC WHITE (22K, 24K, 27K, 30K, 35K, 40K & 57K)							
Ordering Code Example	Lens Length	Overall Length Dimension 'A' E1R+E1R2	Overall Length Dimension 'B' E4R	Overall Length Dimension 'B' E4R2	Total Wattage (5W)	Total Lumens 3000K (5W)	Total Lumens 3000K (7W)
12	12	13	15	17	5	557.0	7.5
20	19.2	20.2	22.2	24.2	8	892	12.0
24	24	25	27	29	10	1103	15.0
32	31.2	32.2	34.2	36.2	13	1434	19.5
36	36	37	39	41	15	1654	22.5
48	48	49	51	53	20	2206	30.0
60	60	61	63	65	25	2757	37.5
72	72	73	75	77	30	3309	45.0
80	79.2	80.2	82.2	84.2	33	3639	49.5
84*	84	85	87	89	35	3860	52.5
87	86.4	87.4	89.4	91.4	36	3970	
99	98.4	99.4	101.4	103.4	41	4522	
108	108	109	111	113	45	4963	
120	120	121	123	125	50	5514	

WARM DIM (27D & 30D)						
Ordering Code Example	Lens Length	Overall Length Dimension 'A' E1R+E1R2	Overall Length Dimension 'B' E4R	Overall Length Dimension 'B' E4R2	Total Wattage (5W)	Total Lumens 3000K (5W)
12	12	13	15	17	5	618
15	15	16	18	20	6.5	764
18	18	19	21	23	7.5	917
24	24	25	27	29	10	1223
36	36	37	39	41	15	1835
48	48	49	51	53	20	2447
60	60	61	63	65	25	3059
72	72	73	75	77	30	3670
96	96	97	99	101	40	4894
120	120	121	123	125	50	6118

*7W Max Length *Maximum length for Chrome is 84"

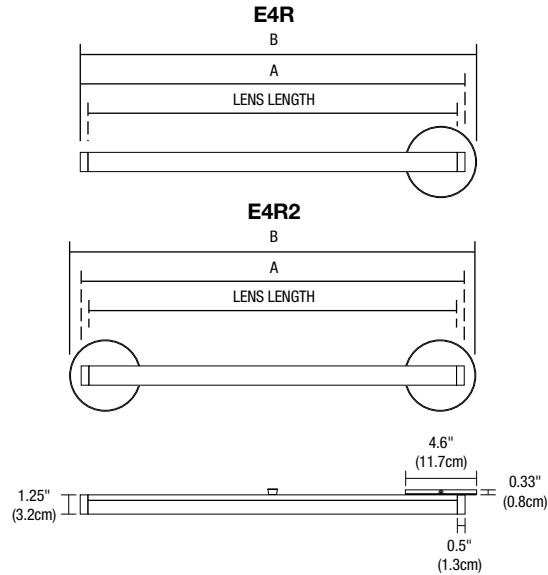
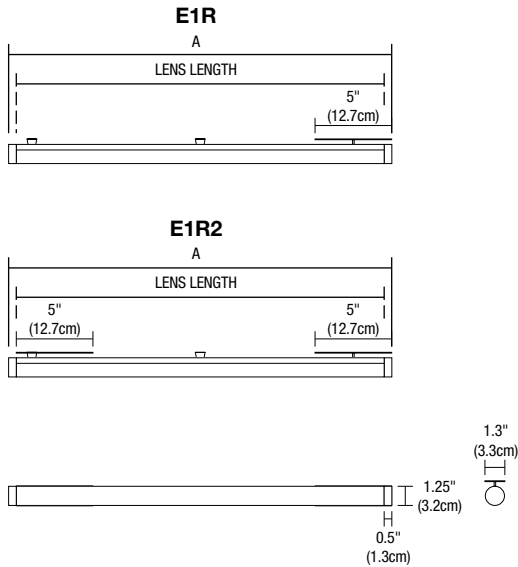

LAMP DATA Lamp Data for Pipeline 2 Wall Vanity - End Feed

PIPELINE VANITY																
DESCRIPTION	STATIC WHITE & WARM DIM															
	5w (4.4 watts)					7w (7.3 watts)										
WATTS FOOT	22K	24K	27K	27D*	30K	30D*	35K	40K	57K	22K	24K	27K	30K	35K	40K	57K
LUMENS PER FOOT (lm/ft)	386	429	471	389	515	425	590	641	682	558	620	681	744	852	926	986
LUMENS PER WATT (lm/w)	88	97	107	81	117	89	134	146	155	77	85	93	102	117	127	135
CRI	85+	90+	95+	95+	95+	95+	85+	84	84	85+	90+	95+	95+	85+	84	84

*27D, 30D - Warm Dim (4.8 Watts)

PROJECT		FIXTURE TYPE		DATE	
---------	--	--------------	--	------	--

PIPELINE® 2 WALL/VANITY

24VDC END FEED VANITY WITH WARM DIM AND STATIC WHITE

8' CHANNEL | 174° BEAM SPREAD | 3000K

5 Watts 174°	
Distance	Foot Candles
1'	201
1.5'	134
2'	102
3'	68
4'	49
5'	37
6'	29
7'	23
8'	18

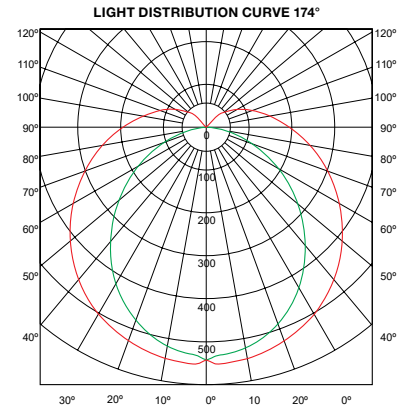
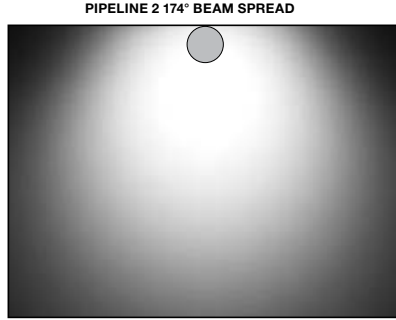

CHROME



SATIN BLACK



SATIN NICKEL



WHITE

FINISHES



P2WDP-5W-E1R-32-30K-BK

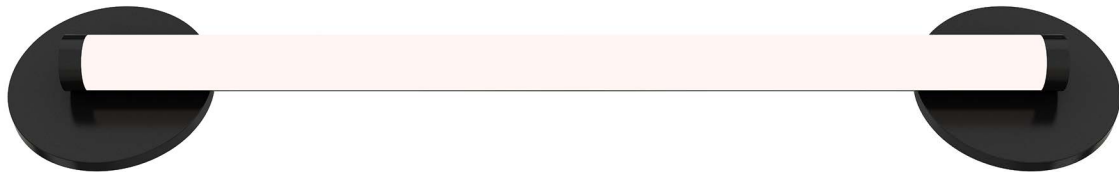

P2WDP-5W-E4R-32-30K-CH



P2WDP-5W-E1R2-32-30K-SN

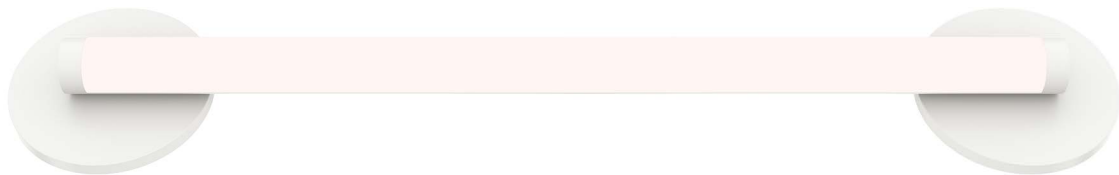









P2WDP-5W-E4R2-32-30K-WH

PROJECT		FIXTURE TYPE		DATE	
---------	--	--------------	--	------	--

INDOOR CONSTANT VOLTAGE REMOTE POWER SUPPLIES

24VDC, UNI - UNIVERSAL DIMMING WITH ELV, TRIAC, & 0-10V

REV 09.24.20

UNIVERSAL POWER SUPPLIES & RECOMMENDED DIMMERS				
ORDERING CODE	PSB-40W-UNI-24VDC 	PSB-60W-UNI-24VDC 	PSB-2X40W-UNI-24VDC 	PSB-2X60W-UNI-24VDC 
SPECIFICATIONS				
MAXIMUM LOAD	40W	60W	2X40W	2X60W
INPUT VOLTAGE	120-277VAC	120-277VAC	120-277VAC	120-277VAC
OUTPUT VOLTAGE	24VDC	24VDC	24VDC	24VDC
DIMENSIONS	12.4" X 3.12" X 2.18"	12.4" X 3.12" X 2.18"	12.15" X 6.48" X 2.18"	12.15" X 6.48" X 2.18"
CLASSIFICATION	CLASS 2	CLASS 2	CLASS 2	CLASS 2
IN-WALL MOUNTING	PSB-40W-UNI-24VDC-IW	PSB-60W-UNI-24VDC-IW	PSB-2X40W-UNI-24VDC-IW	PSB-2X60W-UNI-24VDC-IW
UNIVERSAL POWER SUPPLIES & RECOMMENDED DIMMERS				
ORDERING CODE	PSB-96W-UNI-24VDC 	PSB-2X96W-UNI-24VDC 	PSB-3X96W-UNI-24VDC 	PSB-4X96W-UNI-24VDC 
SPECIFICATIONS				
MAXIMUM LOAD	96W	2X96W	3X96W	4X96W
INPUT VOLTAGE	120-277VAC	120-277VAC	120-277VAC	120-277VAC
OUTPUT VOLTAGE	24VDC	24VDC	24VDC	24VDC
DIMENSIONS	12.4" X 3.12" X 2.18"	12.15" X 6.48" X 2.18"	14" X 10" X 3"	17" X 13" X 3"
CLASSIFICATION	CLASS 2	CLASS 2	CLASS 2	CLASS 2
IN-WALL MOUNTING	PSB-96W-UNI-24VDC-IW	PSB-2X96W-UNI-24VDC-IW	NA	NA
ELV DIMMING & CONTROLS				
LUTRON DIVA: DVELV-300P	•	•	•	•
LUTRON SKYLARK: SELV-300P	•	•	•	•
LUTRON RADIO RA2: RRD-6NA	•	•	•	•
LUTRON MAESTRO: MAELV-600	•	•	•	•
LEGRAND ADORNE: ADTP-703TUM4	•	•	•	•
0-10 DIMMING & CONTROLS				
PHILIPS SUNRISE: SR1200ZTUNV	•	•	•	•
LUTRON DIVA: DVTV-WH, DVSTV-WH	•	•	•	•
LUTRON NOVA T: NTSTV-DV-XX	•	•	•	•
LUTRON GRAFIX EYE QS: QSGRJ-XP	•	•	•	•
LUTRON RADIO RA2: RRD-10ND	•	•	•	•
LEVITON: LEV40050	•	•	•	•
LEVITON IP710-LFZ	•	•	•	•
LEGRAND: ADPD4FBL3P2W4	•	•	•	•
TRIAC DIMMING & CONTROLS				
LUTRON SKYLARK: S2-L-WH	•	•	•	•
LUTRON DIVA DVLV-600P-WH	•	•	•	•
LUTRON DIVA DVLV-603P-WH	•	•	•	•
LUTRON MAESTRO MALV-600-WH	•	•	•	•
LUTRON MAESTRO MALV-1000-WH	•	•	•	•
LUTRON MAESTRO MA-R-XX	•	•	•	•

- Flicker free dimming
- Aluminum casing for optimal heat dissipation
- Isolated output power per NEC and UL safety requirements
- UL & ETL recognized/ listed, meets UL 8750, 1310 requirements
- Auto-reset: short circuit, overload and thermal protection
- Class 2 power supply
- Efficient, High power factor > 0.90
- The Solid State Constant Voltage Uni-Power Supply is compatible with most commercially available Dimmers:
 - Triac Dimmer : (Forward Phase) Typically used for the dimming of Incandescent and Low Voltage Magnetic Transformers
 - ELV Dimmer : (Reverse Phase) Dimming of Electronic Low Voltage Transformers and Power Supply's used for LED lighting
 - 0-10 Dimmer : Dims the Low Voltage side of a 0-10 volt power supply commonly used in large scale lighting or commercial applications.
- The Uni-Power Supply is recommended with any Siemens/Murray brand of arc fault breaker to overcome the issues with tripping the breakers with an ELV LED Low Voltage Drivers.

PROJECT		FIXTURE TYPE		DATE	
---------	--	--------------	--	------	--

IN WALL MOUNTING OPTIONS

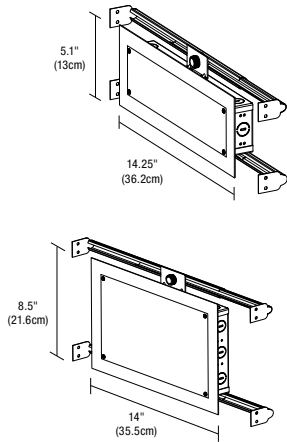

In-Wall Mounting Kit: Includes power supply, box cover and stud hangers for installing Junction Box in wall. Select "IW" in the options section of compatible power supply ordering codes if an In-Wall Mounting Kit is needed.

Ordering Codes 5.1 x 14.25 inch: PSB-40W-UNI-24VDC-IW
 PSB-60W-UNI-24VDC-IW
 PSB-96W-UNI-24VDC-IW

Ordering Codes 8.5 x 14.25 inch: PSB-2X40W-UNI-24VDC-IW
 PSB-2X60W-UNI-24VDC-IW
 PSB-2X96W-UNI-24VDC-IW

WIRING DIAGRAMS UNIVERSAL POWER SUPPLY

Application: ELV dimming for Static White and Warm Dim

Dimming: Dimmable with ELV dimmer: Legrand, Adorne ADTP703TU; Lutron: Diva DVELV-300P, Skylark SELV-300P, Maestro MAELV-600 and Radio Ra 2

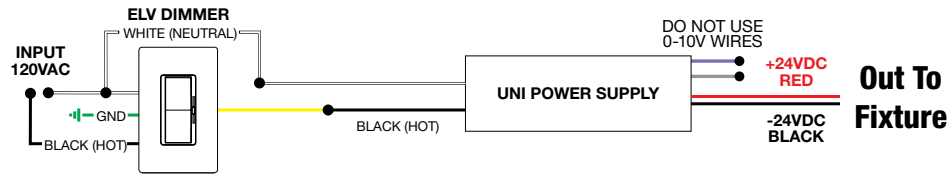

Application: 0-10V dimming for Static White

Dimming: Dimmable with 0-10V dimmer: Philips Sunrise: SR1200ZTUNV; Lutron Diva: DVTV-WH, DVSTV-WH; Lutron Nova T: NTSTV-DV-XX; Lutron Grafix EYE QS: QSGRJ-XP; Lutron Radio Ra2: RRD-10ND; Leviton: LEV40050; Leviton IP710-LFZ; Legrand: ADPD4FBL3P2W4

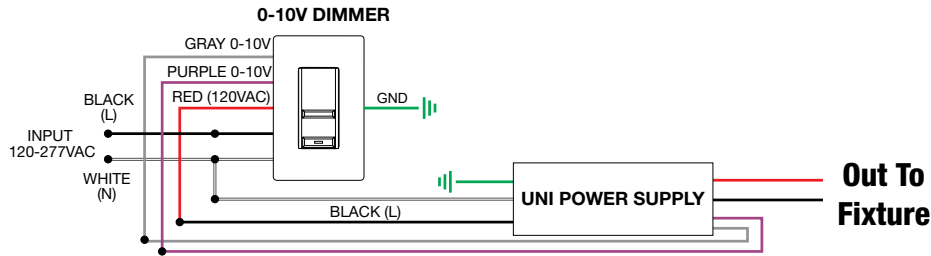

PROJECT		FIXTURE TYPE		DATE	
---------	--	--------------	--	------	--

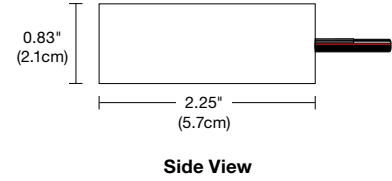
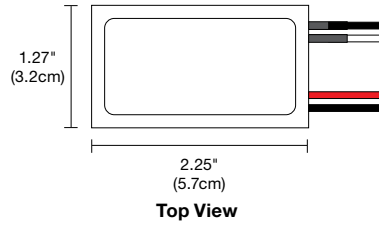
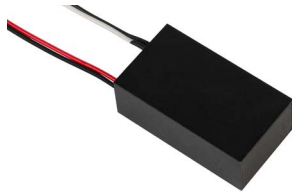

DESCRIPTION

Compact, lightweight remote electronic 60W/24V LED Power Supply* converts standard 120VAC voltage to 24VDC and features built-in short-circuit protection. The low voltage output may be dimmed using an electronic low voltage dimmer. The Power Supply is certified to be used inside a standard Junction Box enclosure. Power Supply features short circuit and overload protection. Indoor applications only.

**Electrical Panels using Siemens/Murray AFCI breakers are not compatible with this ELV transformer. Use 0-10 Volt power supplies with this breaker.*

APPLICATIONS

Indoor*
To avoid overheating the power supply, install it in a ventilated remote location where air flows. Maintain proper spacing among power supplies when multiple power supplies are installed in the same remote location.

- POWER INPUT** 120 volts AC, 60Hz
- POWER OUTPUT** Class 2; 24 volts DC 2.5A 60 watt maximum
- DIMENSIONS** 2.25" x 1.25" x 0.83"
- DIMMER TYPE** Electronic Low Voltage Dimmer Lutron: Diva #DVELV-300P; Skylark #SELV-300P; Maestro #MAELV-600

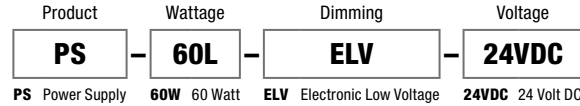
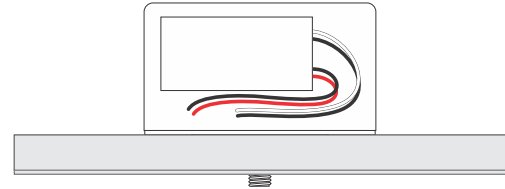

SAMPLE WIRING DIAGRAMS 24VDC ELV

- Application:** ELV dimming for Static White
- Dimming:** Dimmable with ELV dimmer: Legrand, Adorne ADTP703TU; Lutron: Diva DVELV-300P, Skylark SELV-300P, Maestro MAELV-600 and Radio Ra 2

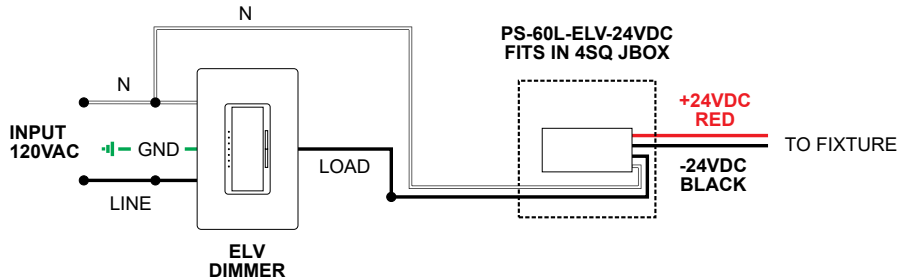

PROJECT		FIXTURE TYPE		DATE	
---------	--	--------------	--	------	--

WALL/VANITY TM30 DATA

24VDC END FEED VANITY WITH WARM DIM AND STATIC WHITE

TM-30-15 DATA: The data below is for SS5C and SS7C bare LED Soft Strips. Consistent color temperatures throughout a single strip and among multiple strips is possible through a 3 phase binning process in which each order is inspected with a color meter to ensure uniformity.

2200K | Rf: 83.9 | Rg: 94.9

Color Vector Graphic

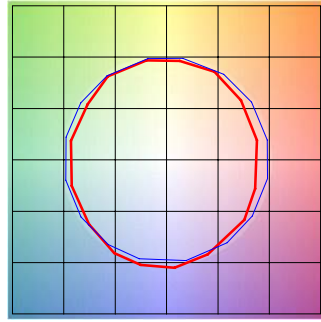

■ Test ■ Reference

GRAPHIC SHIFTS %			
HUE BIN	Rf	CHROMA	HUE
1	77.6	-10.0%	1.8%
2	80.7	-7.5%	7.0%
3	79.5	-2.9%	8.9%
4	90.5	-3.1%	2.4%
5	93.9	-1.3%	1.9%
6	91.9	-0.9%	-0.2%
7	87.6	-6.3%	-2.7%
8	90.5	-5.4%	2.7%
9	83.8	-4.7%	6.5%
10	81.2	-2.5%	10.0%
11	83.3	3.9%	9.4%
12	86.4	5.6%	2.6%
13	86.2	4.5%	-12.4%
14	64.3	-1.0%	-21.9%
15	85.1	-4.4%	-7.5%
16	75.0	-9.9%	-12.0%

2400K | Rf: 91.2 | Rg: 96.8

Color Vector Graphic

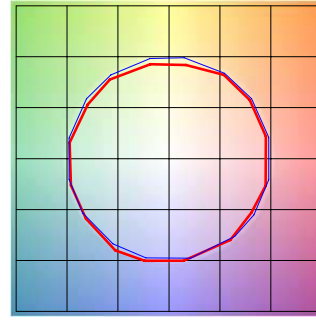

■ Test ■ Reference

GRAPHIC SHIFTS %			
HUE BIN	Rf	CHROMA	HUE
1	92.0	-2.4%	1.5%
2	94.7	-2.1%	0.0%
3	95.4	-1.9%	-0.1%
4	88.7	-6.7%	-3.1%
5	92.8	-5.6%	1.0%
6	92.7	-3.4%	3.4%
7	89.9	-4.3%	4.1%
8	92.4	-1.4%	4.4%
9	89.0	-0.6%	5.8%
10	88.9	0.4%	6.2%
11	89.7	4.0%	5.4%
12	92.6	3.0%	-0.7%
13	90.9	1.1%	-7.0%
14	89.9	0.5%	-5.8%
15	92.1	-3.2%	0.1%
16	88.9	-1.7%	-6.3%

2700K | Rf: 87.7 | Rg: 96.1

Color Vector Graphic

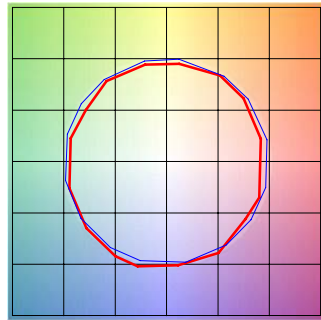

■ Test ■ Reference

GRAPHIC SHIFTS %			
HUE BIN	Rf	CHROMA	HUE
1	86.4	-5.6%	2.3%
2	89.7	-3.3%	3.1%
3	90.5	-1.5%	3.8%
4	90.0	-4.3%	1.1%
5	92.9	-3.7%	0.2%
6	93.5	-2.5%	-0.8%
7	86.3	-7.2%	2.5%
8	90.7	-4.0%	3.2%
9	85.2	-2.4%	8.1%
10	81.7	0.9%	10.8%
11	85.4	4.5%	8.9%
12	88.7	5.7%	-1.4%
13	88.3	1.3%	-7.9%
14	85.1	2.4%	-10.4%
15	88.1	-4.8%	-2.7%
16	81.7	-4.3%	-10.9%

3000K | Rf: 88.1 | Rg: 99.7

Color Vector Graphic

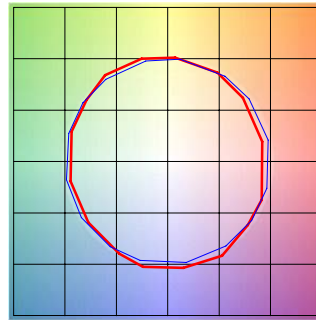

■ Test ■ Reference

GRAPHIC SHIFTS %			
HUE BIN	Rf	CHROMA	HUE
1	87.7	-5.9%	-0.3%
2	87.9	-4.4%	4.3%
3	82.9	-1.2%	7.9%
4	89.9	0.6%	4.7%
5	92.7	3.0%	3.5%
6	92.7	3.6%	-1.7%
7	90.8	-1.3%	-4.4%
8	93.7	-2.5%	-2.2%
9	91.7	-3.7%	2.3%
10	85.5	-2.8%	7.8%
11	83.3	0.7%	11.0%
12	86.4	5.5%	3.8%
13	90.6	4.6%	-3.6%
14	85.6	5.9%	-8.4%
15	89.5	-0.6%	-5.7%
16	82.6	-2.7%	-12.0%

3500K | Rf: 86.1 | Rg: 95.5

Color Vector Graphic

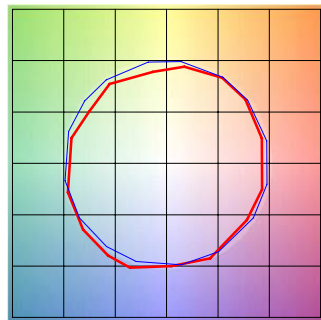

■ Test ■ Reference

GRAPHIC SHIFTS %			
HUE BIN	Rf	CHROMA	HUE
1	86.6	-4.2%	3.4%
2	91.7	-1.4%	1.8%
3	94.9	-0.7%	0.4%
4	87.9	-4.5%	-4.1%
5	85.9	-10.3%	-2.7%
6	89.8	-5.2%	-0.4%
7	79.6	-9.5%	6.5%
8	87.6	-4.0%	5.7%
9	81.4	-0.5%	11.8%
10	78.3	3.3%	11.4%
11	85.7	6.3%	6.1%
12	86.3	7.1%	-4.6%
13	86.1	-0.7%	-9.6%
14	85.1	0.8%	-10.4%
15	83.4	-4.1%	-5.3%
16	82.5	-3.6%	-5.7%

4000K | Rf: 87.6 | Rg: 96.8

Color Vector Graphic

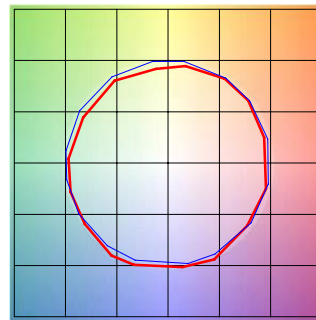

■ Test ■ Reference

GRAPHIC SHIFTS %			
HUE BIN	Rf	CHROMA	HUE
1	89.0	-3.1%	2.1%
2	93.2	-0.9%	1.3%
3	94.3	-1.1%	0.7%
4	89.5	-4.0%	-2.3%
5	87.6	-7.8%	-1.8%
6	92.2	-4.6%	0.1%
7	87.4	-6.6%	3.6%
8	85.7	-3.8%	7.0%
9	81.5	-1.3%	12.4%
10	80.0	0.9%	11.4%
11	83.3	5.9%	8.7%
12	89.7	4.8%	-0.3%
13	88.5	2.4%	-6.3%
14	92.7	4.0%	-3.8%
15	86.1	-1.6%	-4.5%
16	85.0	-1.4%	-5.0%

PROJECT	FIXTURE TYPE	DATE
---------	--------------	------

WALL/VANITY TM30 DATA

24VDC END FEED VANITY WITH WARM DIM AND STATIC WHITE

TM-30-15 DATA: The data below is for SS5C and SS7C bare LED Soft Strips. Consistent color temperatures throughout a single strip and among multiple strips is possible through a 3 phase binning process in which each order is inspected with a color meter to ensure uniformity.

5700K | Rf: 80.3 | Rg: 91.5

Color Vector Graphic

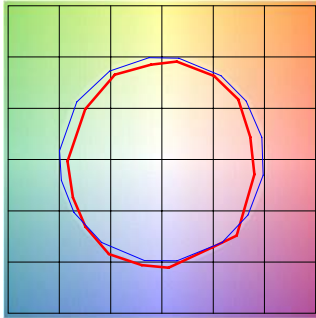

■ Test ■ Reference

HUE BIN	Rf	GRAPHIC SHIFTS %	
		CHROMA	HUE
1	73.8	-11.2%	2.6%
2	83.7	-5.5%	5.8%
3	84.2	-4.0%	5.5%
4	85.8	-3.5%	1.3%
5	85.3	-7.1%	0.6%
6	89.2	-5.8%	-2.2%
7	81.5	-10.7%	1.2%
8	75.7	-9.7%	8.5%
9	74.9	-7.8%	18.8%
10	67.8	-1.6%	18.0%
11	76.1	5.5%	12.0%
12	90.8	4.9%	-1.6%
13	83.6	5.0%	-9.5%
14	81.7	-1.2%	-10.0%
15	69.0	2.0%	-22.8%
16	83.2	-8.5%	-1.0%

2700D | Rf: 89.5 | Rg: 100.8

Color Vector Graphic

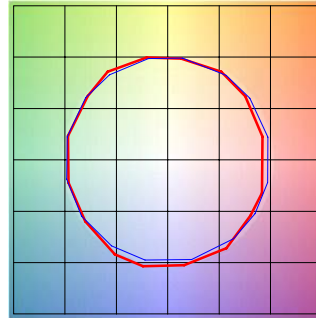

■ Test ■ Reference

HUE BIN	Rf	GRAPHIC SHIFTS %	
		CHROMA	HUE
1	88.8	-5.1%	1.4%
2	89.8	-2.7%	4.1%
3	87.2	0.3%	5.9%
4	92.3	-0.9%	1.0%
5	93.3	1.5%	1.7%
6	92.4	3.6%	-0.2%
7	92.2	-0.9%	-2.4%
8	96.7	-0.4%	-1.1%
9	92.3	-1.2%	3.7%
10	88.9	-0.0%	6.1%
11	86.4	5.1%	7.4%
12	88.2	6.3%	-0.9%
13	87.2	3.8%	-8.1%
14	84.2	3.8%	-11.0%
15	89.8	-2.6%	-4.3%
16	82.7	-3.4%	-11.1%

3000D | Rf: 89.8 | Rg: 101.4

Color Vector Graphic

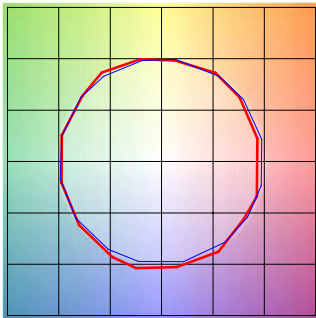

■ Test ■ Reference

HUE BIN	Rf	GRAPHIC SHIFTS %	
		CHROMA	HUE
1	90.2	-4.2%	1.5%
2	90.9	-2.0%	3.7%
3	87.9	0.8%	5.5%
4	92.1	-0.9%	0.6%
5	93.0	1.5%	1.6%
6	92.2	3.9%	-0.2%
7	92.1	-0.3%	-2.0%
8	96.7	0.0%	-1.2%
9	92.5	-0.6%	3.7%
10	88.3	1.1%	7.0%
11	87.2	4.1%	7.4%
12	87.2	6.7%	-1.0%
13	88.2	3.8%	-7.2%
14	85.3	4.3%	-9.9%
15	90.9	-2.2%	-3.6%
16	83.4	-2.2%	-11.2%

PROJECT	FIXTURE TYPE	DATE
---------	--------------	------