



MINI STAR LINEAR LED OUTDOOR HIGH OUTPUT

24VDC, 12 WATTS PER FOOT, IP66 STATIC WHITE AND STATIC COLOR



REV 08.28.20

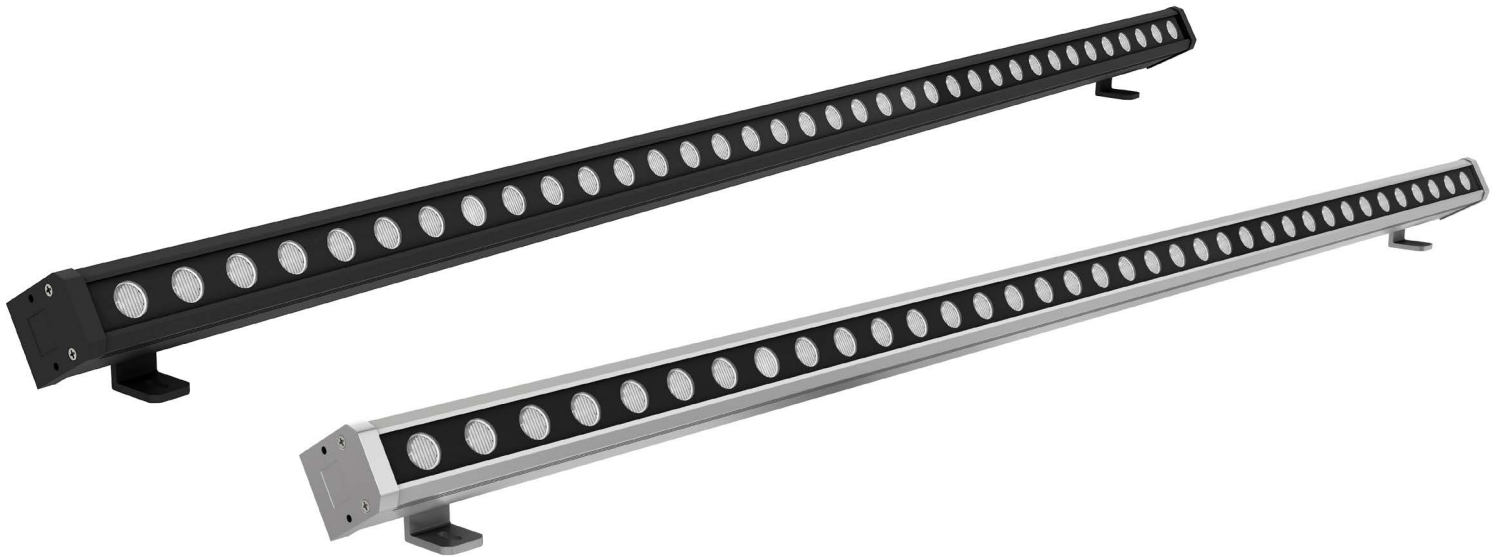

DESCRIPTION

Clean lines paired with a minimal profile create the Mini Star Outdoor Linear LED fixture. Using state-of-the-art technology the Mini Star is a workhorse housed in a compact design. Proprietary thermal convection enables rapid transference of heat in combination with High Powered LED's, makes the Mini Star an unparalleled source of light. With ability to mount on the ceiling, wall or floor with adjustable mounting clips and your choice of various oval lenses and wall wash functionality, the Mini Star has numerous outdoor applications. Power the Mini Star IP66 Rated fixture with PureEdge's Wet Rated Universal Dimming (ELV, 0-10, TRIAC) Power Supply or from a remote indoor location (Sold Separately). Multiple Mini Stars can be ganged together, up to 100 watts, before re-feeding.

ELECTRICAL

- Input Voltage: 24VDC.
- Universal Power Supply 120/277VAC-24VDC, Sold Separately SKU: **PSB-96W-UNI-24VDC-W**
- Class 2 Power Supply
- Power Consumption of 12 watts per foot
- LED's/FT: 8
- Order in 4 Wattage/Length options, and gang multiple fixtures together, up to 100 watts before re-feeding.
- Cable Connector: **OC-CFX-2CON-(12IN or 96IN)-W** Cord conductors can be ordered to gang multiple fixtures together for a watertight connection.
- Dimming: Universal (ELV, 0-10, TRIAC)

FINISHES



Black Powder Coat
BK



Satin Aluminum
SA

FEATURES & BENEFITS

- Standard lengths: 24" or 48" at 12w per foot
- Static White Color Temperature Options: 2200K / 2700K / 3000K / 4000K or 5000K
- Static Color Options: Red, Green, Blue, Amber
- Adjustable Mounting Clips: Innovative mounting clips are attached for Ground Level, Ceiling, or Wall mounting options; for Wall Grazing, Wall Washing, and general outdoor lighting applications
- Easy Installation: Push-IN Water Right Barrel Connectors
- Beam Spread: 40°, 60° and 12°x53° Oval
- 2 Finish Options: Satin Aluminum or Black Powder Coated Finish

LUMEN PERFORMANCE DATA

Based on 3000K 48" at 48 Watts, with 15°x30° Oval Lens

- Lumen: 3018
- Efficiency: 63 LM/W
- CRI: 83

PHYSICAL

- Material: Low Copper Aluminum Die Casting with High Pure Aluminum Alloy Extrusion, High Weather Resistant Outdoor Powder Coated Finish, Tempered Optical Glass Diffuser 1.25" thick LED COB
- Sizes: **24W24** (24" x 1.7" x 2") and **48W48** (48" x 1.7" x 2")
- Operating Temperature: -4°F to 113°F
- Average LED Life: 50,000 Hours

COMPLIANCE

- Class 2 Power Supply
- ETL Listed
- IP66 Wet Rated

WARRANTY

5 Year Pro-rated Warranty from Time of Purchase

System	Wattage & Length	Beam Spread	Color Temperature	Finish
MSLO-24V	48W48	60	30K	SA
MSLO-24V Mini Star Linear Outdoor 2VDC System	24W24 24 Watts, 24" 48W48 48 Watts, 48"	40 40° Lens 60 60° Lens 12X53 12x53° Oval Lens	22K 2200K Amber White 27K 2700K Incandescent White 30K 3000K Warm White 40K 4000K Cool White 50K 5000K Daylight White	AAA Amber BBB Blue GGG Green RRR Red SA Satin Aluminum BK Black Powder Coated

PROJECT	FIXTURE TYPE	DATE
---------	--------------	------

MINI STAR LINEAR LED OUTDOOR

24VDC, 12 WATTS PER FOOT, IP66 STATIC WHITE AND STATIC COLOR

REV 08.28.20

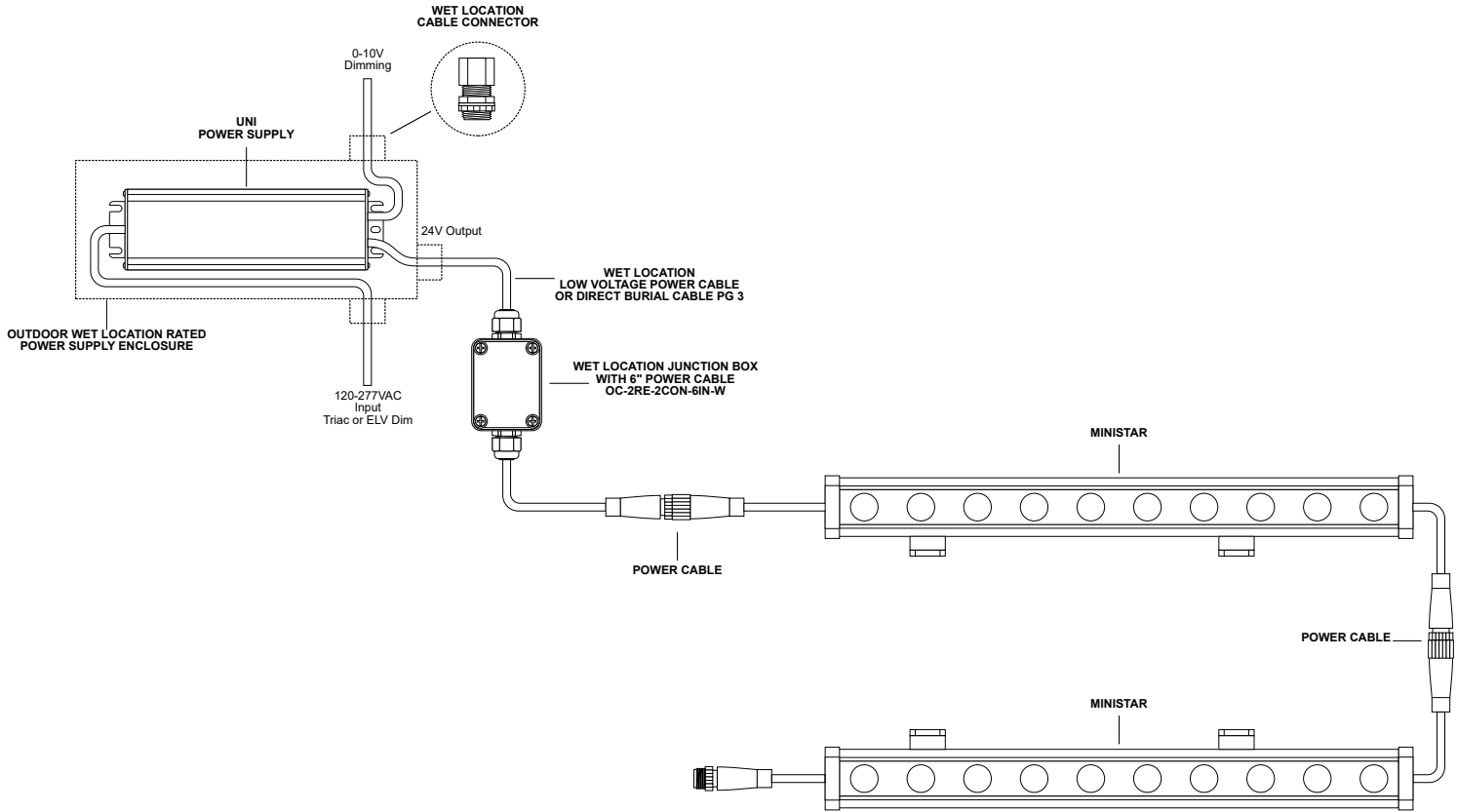
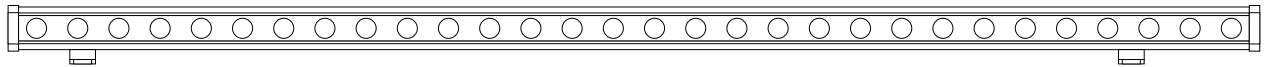
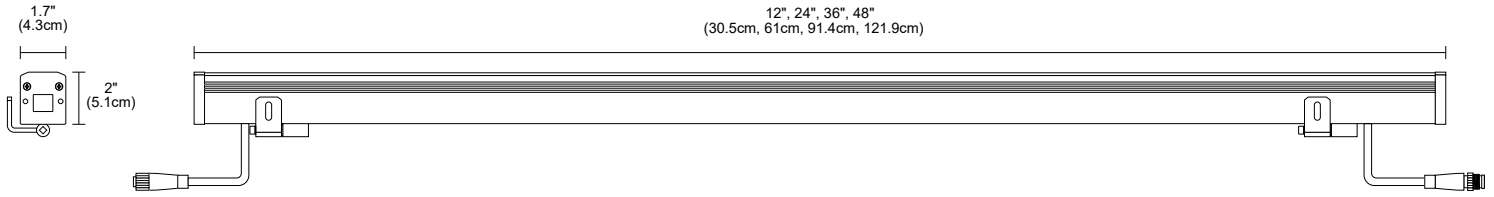

Nominal Beam Spread

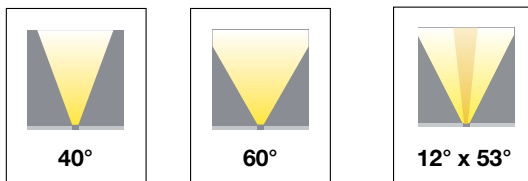

Nominal Light Distribution Graphs

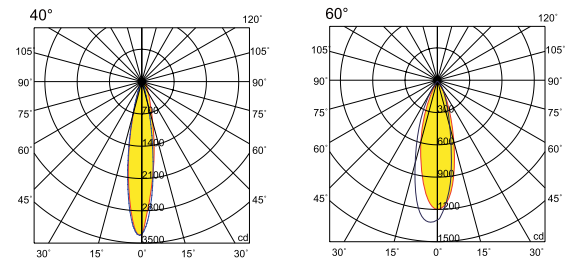

PROJECT		FIXTURE TYPE		DATE	
---------	--	--------------	--	------	--

MINI STAR LINEAR LED OUTDOOR

24VDC, 12 WATTS PER FOOT, IP66 STATIC WHITE AND STATIC COLOR

Components: Components for the Mini Star Linear Fixture

WET LOCATION JUNCTION BOX

Wet-rated low voltage Splice Box with connectors.

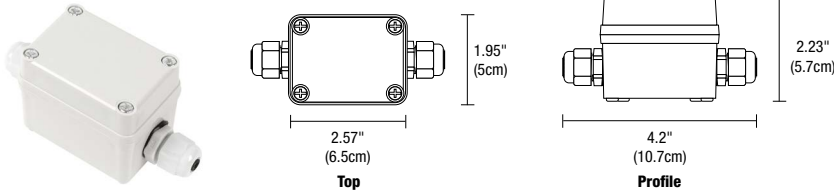

Product	Type	Option
2RE	JBOX	W
2RE 2" Rectangle	JBOX Junction Box	W Wet Location

WET LOCATION JUNCTION BOX WITH 6" POWER CABLE

This watertight, multi-fixture Junction Box is especially designed for lighting in wet and damp locations. It is versatile, rugged and simple to install. The Junction Box comes standard with a 6" Flexible Cable providing easy, safe, and reliable connections for 24V low voltage luminaires. This box is approved for indoor and outdoor usage and complies with all the requirements of UL1241 and the National Electric Code.

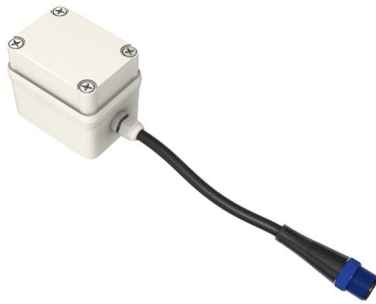

Product	Canopy	Product	Size	Option
OC	2RE	2CON	6IN	W
OC Outdoor Cable	2RE 2" Rectangle	2CON 2 Pin Connector	6IN 6"	W Wet Location

WET LOCATION POWER/JUMPER CABLE

This Flexible Connector is designed to work with all of our Linear Outdoor Systems in outdoor damp and wet environments. This Flexible Connector is easy to install and configure, helping you create innovative lighting designs. Length 12" or 96", may cut one end off and use for power feed connector.

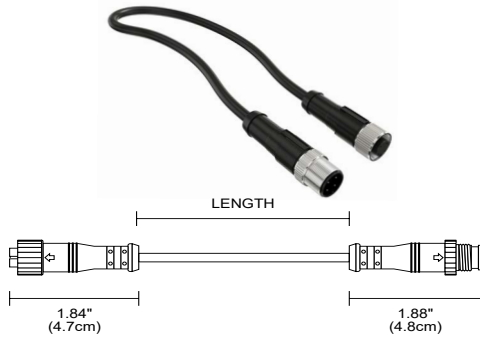

Product	Type	Product	Size	Option
OC	CFX	2CON	12IN	W
OC Outdoor Cable	CFX Flexible Connector	2CON 2 Pin Connector	12IN 12" 96IN 96"	W Wet Location

DB-12G-2C-25FT

DIRECT BURIAL LOCATION CABLE ORDER PER FOOT

Our Direct Burial, 2 Conductor, 12 Gage Cable is a durable and adaptable cable suitable for transmitting power, control, and switching in outdoor wet and in ground environments. Keep within 60 ft between fixture and power supply.



Product	Gauge	Cable	Length
DB	12G	2C	25FT
DB Direct Burial	12G 12 Gauge	2C 2 Conductor	25FT 25 Feet 50FT 50 Feet 100FT 100 Feet

OC-14G-5C-25FT

WET AND DAMP LOCATION CABLE ORDER PER FOOT

Our Wet Location, 5 Conductor, 14 Gage Cable is a durable and adaptable cable suitable for transmitting power, control, and switching in indoor and outdoor wet and damp environments. Cable sold by the foot, simply specify the length needed by the foot. Keep within 50 ft between fixture and power supply.

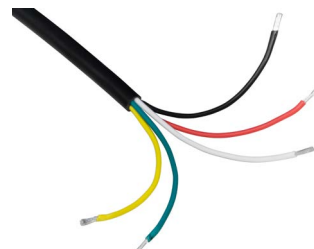

Product	Gauge	Cable	Length
OC	14G	5C	25FT
OC Outdoor Cable	14G 14 Gauge	5C 5 Conductor	25FT 25 Feet 50FT 50 Feet 100FT 100 Feet

PROJECT	FIXTURE TYPE	DATE
---------	--------------	------

OUTDOOR CONSTANT VOLTAGE REMOTE POWER SUPPLIES

24VDC, UNI - UNIVERSAL DIMMING WITH ELV, TRIAC, & 0-10V WET LOCATION

REV. 08.28.20



Con-1-2CORD-O Cord conductors included

UNI POWER SUPPLY

Universal Power Supply: 120/277VAC-24VDC with Universal dimming ELV, Triac or 0-10V dimmers. 100-0% Flicker free dimming. Aluminum casing for optimal heat dissipation. Isolated output power per NEC and UL safety requirements. UL & ETL recognized/ listed, meets UL8750, 1310 requirement. Auto-reset; short circuit, overload and thermal protection. Class 2 power supply. Efficient, High power factor > 0.90. Exceeds California Title 24 Requirements AAA rating. Efficiency > 84% Power Factor > 0.90. Case TC 90°C Max. Protection Input / Output Storage -30°C / +90°C Humidity 95% RH Max. Class 2 Power Supply Dimming ELV, Triac, 0-10V IP Rating IP20, IP67



Product	Wattage	Type	Voltage	Option
PSB	60W	UNI	24VDC	W
PSB Power Supply with junction box	60W 60 Watts 96W 96 Watts	UNI Uni Driver	24VDC 24VDC	W Wet Location

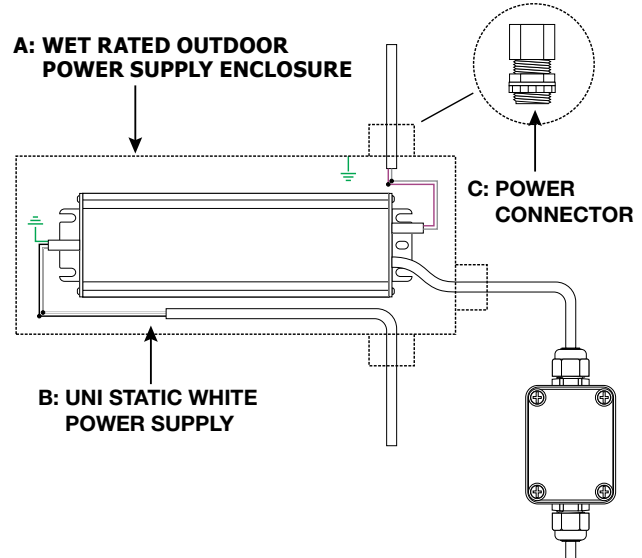
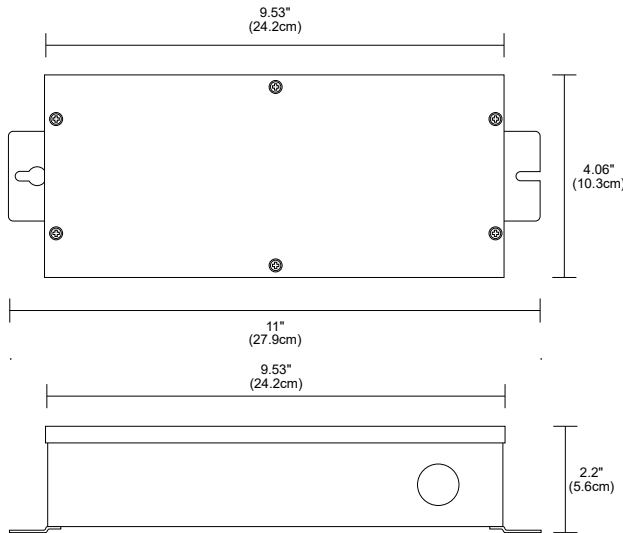

COMPATIBLE DIMMERS:

ELV DIMMING & CONTROLS
LEGRAND ADORNE: ADTP-703TUM4
0-10 DIMMING & CONTROLS
PHILIPS SUNRISE: SR1200ZTUNV
LEVITON: LEV40050
LEVITON IP710-LFZ
LEGRAND: ADPD4FBL3P2W4

A. WET RATED OUTDOOR POWER SUPPLY ENCLOSURE

Use of Outdoor LED Mini Star requires a Wet Location Junction Box to house the wire connection from the LED Mini Star to Power Supply. The Outdoor Connection Box is sold separately.

B. UNI POWER SUPPLY

Outdoor-rated Power Supplies are required for use with a Outdoor LED Mini Star, and are sold separately. May be dimmed with ELV, Triac or 0-10 120/277-24VDC

C. POWER CONNECTOR

Power Connector connects the LED Mini Star to remote power supply.

- Flicker free dimming
- Class 2 power supply
- Efficient, High power factor > 0.90
- Aluminum casing for optimal heat dissipation
- Isolated output power per NEC and UL safety requirements

- UL & ETL recognized/ listed, meets UL 8750, 1310 requirements
- Auto-reset; short circuit, overload and thermal protection
- The Solid State Constant Voltage Uni-Power Supply is compatible with most commercially available Dimmers:
 - Triac Dimmer: (Forward Phase) Typically used for the dimming of Incandescent and Low Voltage Magnetic Transformers
 - ELV Dimmer: (Reverse Phase) Dimming of Electronic Low Voltage Transformers and Power Supply's used for LED lighting
 - 0-10 Dimmer: Dims the Low Voltage side of a 0-10 volt power supply commonly used in large scale lighting or commercial applications.
- The Uni-Power Supply is recommended with any Siemens/Murray brand of arc fault breaker to overcome the issues with tripping the breakers with an ELV LED Low Voltage Drivers.

PROJECT		FIXTURE TYPE		DATE	
---------	--	--------------	--	------	--

INDOOR CONSTANT VOLTAGE REMOTE POWER SUPPLIES

24VDC, UNI - UNIVERSAL DIMMING WITH ELV, TRIAC, & 0-10V

REV 08.28.20

UNIVERSAL POWER SUPPLIES & RECOMMENDED DIMMERS				
ORDERING CODE	PSB-40W-UNI-24VDC 	PSB-60W-UNI-24VDC 	PSB-2X40W-UNI-24VDC 	PSB-2X60W-UNI-24VDC
SPECIFICATIONS				
MAXIMUM LOAD	40W	60W	2X40W	2X60W
INPUT VOLTAGE	120-277VAC	120-277VAC	120-277VAC	120-277VAC
OUTPUT VOLTAGE	24VDC	24VDC	24VDC	24VDC
DIMENSIONS	12.4" X 3.12" X 2.18"	12.4" X 3.12" X 2.18"	12.15" X 6.48" X 2.18"	12.15" X 6.48" X 2.18"
CLASSIFICATION	CLASS 2	CLASS 2	CLASS 2	CLASS 2
IN-WALL MOUNTING	PSB-40W-UNI-24VDC-IW	PSB-60W-UNI-24VDC-IW	PSB-2X40W-UNI-24VDC-IW	PSB-2X60W-UNI-24VDC-IW
UNIVERSAL POWER SUPPLIES & RECOMMENDED DIMMERS				
ORDERING CODE	PSB-96W-UNI-24VDC 	PSB-2X96W-UNI-24VDC 	PSB-3X96W-UNI-24VDC 	PSB-4X96W-UNI-24VDC
SPECIFICATIONS				
MAXIMUM LOAD	96W	2X96W	3X96W	4X96W
INPUT VOLTAGE	120-277VAC	120-277VAC	120-277VAC	120-277VAC
OUTPUT VOLTAGE	24VDC	24VDC	24VDC	24VDC
DIMENSIONS	12.4" X 3.12" X 2.18"	12.15" X 6.48" X 2.18"	14" X 10" X 3"	17" X 13" X 3"
CLASSIFICATION	CLASS 2	CLASS 2	CLASS 2	CLASS 2
IN-WALL MOUNTING	PSB-96W-UNI-24VDC-IW	PSB-2X96W-UNI-24VDC-IW	NA	NA
ELV DIMMING & CONTROLS				
LUTRON DIVA: DVELV-300P	•	•	•	•
LUTRON SKYLARK: SELV-300P	•	•	•	•
LUTRON RADIO RA2: RRD-6NA	•	•	•	•
LUTRON MAESTRO: MAELV-600	•	•	•	•
LEGRAND ADORNE: ADTP-703TUM4	•	•	•	•
0-10 DIMMING & CONTROLS				
PHILIPS SUNRISE: SR1200ZTUNV	•	•	•	•
LUTRON DIVA: DVTW-WH, DVSTV-WH	•	•	•	•
LUTRON NOVA T: NTSTV-DV-XX	•	•	•	•
LUTRON GRAFIX EYE QS: QSGRJ-XP	•	•	•	•
LUTRON RADIO RA2: RRD-10ND	•	•	•	•
LEVITON: LEV40050	•	•	•	•
LEVITON IP710-LFZ	•	•	•	•
LEGRAND: ADPD4FBL3P2W4	•	•	•	•
TRIAC DIMMING & CONTROLS				
LUTRON SKYLARK: S2-L-WH	•	•	•	•
LUTRON DIVA DVLV-600P-WH	•	•	•	•
LUTRON DIVA DVLV-603P-WH	•	•	•	•
LUTRON MAESTRO MALV-600-WH	•	•	•	•
LUTRON MAESTRO MALV-1000-WH	•	•	•	•
LUTRON MAESTRO MA-R-XX	•	•	•	•

- Flicker free dimming
- Aluminum casing for optimal heat dissipation
- Isolated output power per NEC and UL safety requirements
- UL & ETL recognized/ listed, meets UL 8750, 1310 requirements
- Auto-reset: short circuit, overload and thermal protection
- Class 2 power supply
- Efficient, High power factor > 0.90
- The Solid State Constant Voltage Uni-Power Supply is compatible with most commercially available Dimmers:
 - Triac Dimmer : (Forward Phase) Typically used for the dimming of Incandescent and Low Voltage Magnetic Transformers
 - ELV Dimmer : (Reverse Phase) Dimming of Electronic Low Voltage Transformers and Power Supply's used for LED lighting
 - 0-10 Dimmer : Dims the Low Voltage side of a 0-10 volt power supply commonly used in large scale lighting or commercial applications.
- The Uni-Power Supply is recommended with any Siemens/Murray brand of arc fault breaker to overcome the issues with tripping the breakers with an ELV LED Low Voltage Drivers.

PROJECT	FIXTURE TYPE	DATE
---------	--------------	------

IN WALL MOUNTING OPTIONS

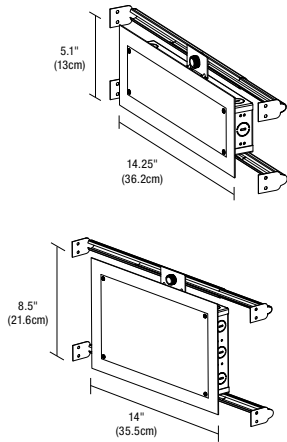

In-Wall Mounting Kit: Includes power supply, box cover and stud hangers for installing Junction Box in wall. Select "IW" in the options section of compatible power supply ordering codes if an In-Wall Mounting Kit is needed.

Ordering Codes 5.1 x 14.25 inch: PSB-40W-UNI-24VDC-IW
PSB-60W-UNI-24VDC-IW
PSB-96W-UNI-24VDC-IW

Ordering Codes 8.5 x 14.25 inch: PSB-2X40W-UNI-24VDC-IW
PSB-2X60W-UNI-24VDC-IW
PSB-2X96W-UNI-24VDC-IW

WIRING DIAGRAMS UNIVERSAL POWER SUPPLY

Application: ELV dimming for Static White and Warm Dim

Dimming: Dimmable with ELV dimmer: Legrand, Adorne ADTP703TU; Lutron: Diva DVELV-300P, Skylark SELV-300P, Maestro MAELV-600 and Radio Ra 2

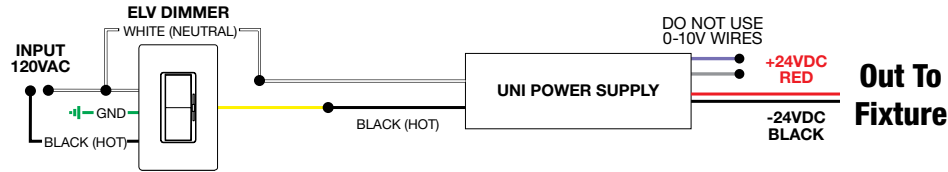

Application: 0-10V dimming for Static White

Dimming: Dimmable with 0-10V dimmer: Philips Sunrise: SR1200ZTUNV; Lutron Diva: DVTV-WH, DVSTV-WH; Lutron Nova T: NTSTV-DV-XX; Lutron Grafix EYE QS: QSGRJ-XP; Lutron Radio Ra2: RRD-10ND; Leviton: LEV40050; Leviton IP710-LFZ; Legrand: ADPD4FBL3P2W4

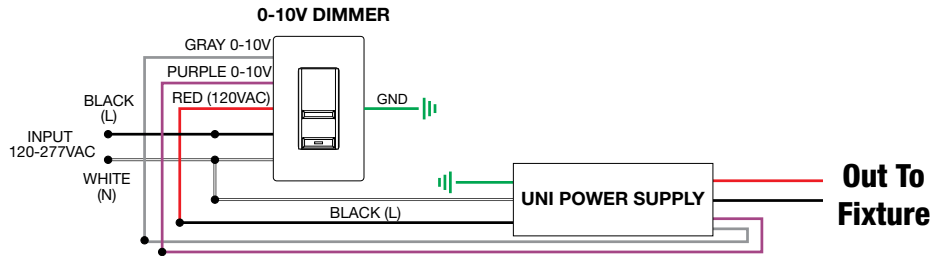

PROJECT	FIXTURE TYPE	DATE
---------	--------------	------