

DESCRIPTION

Glide Glass Up/Down is a linear LED lighting 2 circuit system that features both direct and indirect light. This contemporary system allows you to create a fixture perfectly sized for your space. With its availability in various increments, 60° up light and a 100° down light, optional black or white louvers with an assortment of finishes and Warm Dim options. Fixture includes 5 year pro-rated warranty. For custom designs and quotes, send drawings to design@PureEdgeLighting.com.

INSTALLATION

- Includes canopy with 120V/24VDC power supply Class 2 output
- Includes adjustable 12 foot coaxial cables (additional aircraft cables added for support when fixture exceeds 84")
- Electronic Low Voltage LED power supply

FINISHES

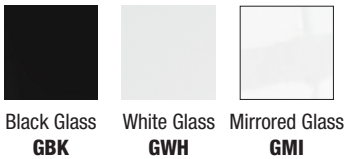

Black Glass **GBK** White Glass **GWH** Mirrored Glass **GMI**

LENSES

- Downlight - Diffused White 100° down light Lens with White or Black Louver
- Uplight - Clear Frosted 60° Lens

LAMP

- Choose from 9 different color temperatures from 22K - 57K including Warm Dim
- Warm Dim - 2700K to 2000K (**27D**) or 3000K to 2000K (**30D**)
- 50,000 Hour Lamp Life

POWER SUPPLY (INCLUDED IN CANOPY)

- 120V input, 24VDC Class 2 output; electronic low voltage LED power supply

*For nLight compatibility please refer to our remote power supply specifications or contact us for a custom quotation.

DIMMING

- Dimmable with ELV dimmer: Legrand, Adorne ADTP703TU
- Lutron: Diva DVELV-300P, Skylark SELV-300P, Maestro MAELV-600 and Radio Ra 2

*Dimmers not available through PureEdge Lighting

APPLICATIONS

Designed for indoor use only. Ideal environments include: kitchens, dining rooms, hallways, conference rooms, offices, architectural, general and retail.

System	Wattage Per Foot	Power Feed	Nominal Size (in)	Color Temperature	Glass Finish
GLUD	7W	E	60	27K	GBK
GLUD Glide Up and Down	7W 7.5 Watt 24VDC (2W up and 5W down)	E End Feed	36 36" 84 84"	22K 2200K Amber White	GBK Black Glass
GLUDB Glide Up and Down with Black Louver	10W 10 Watt 24VDC (5W up and 5W down)	E2 End Feed (2 Canopies)	48 48" 96 96"	24K 2400K Very Warm White	GWH White Glass
GLUDW Glide Up and Down with White Louver	12W 12 Watt 24VDC (5W up and 7.5W down)		60 60" 108 108" 72 72" 120 120"	27K 2700K Incandescent White 27D 2700K Warm Dim (10W only) 30K 3000K Warm White 30D 3000K Warm Dim (10W only) 35K 3500K Neutral White 40K 4000K Cool White 57K 5700K Daylight White	GMI Mirrored Glass

PROJECT	FIXTURE TYPE	DATE
---------	--------------	------

GLIDE GLASS UP/DOWN LIGHT

END FEED WITH POWER IN CANOPY

NOMINAL LAMP DATA: Lamp data for Uplight Channel

DESCRIPTION	GLUD, GLUDW, GLUDB															
	60° Diffused Clear - Uplight															
WATTS PER FOOT	2w (2.5 watts)								5w (4.4 watts)							
COLOR TEMPERATURE	22K	24K	27K	30K	35K	40K	57K	22K	24K	27K	27D*	30K	30D*	35K	40K	57K
LUMENS PER FOOT (lm/ft)	126	140	154	168	192	209	222	242	268.5	295	267	322	292	369	401	427
LUMENS PER WATT (lm/w)	50	55.5	61	67	77	84	89	55	61	67	56	73	61	84	91	97
CRI	85+	90+	95+	95+	85+	84	84	85+	90+	95+	95+	95+	95+	85+	84	84

*27D, 30D - Warm Dim (4.8 Watts)

LAMP DATA: Lamp data for Downlight Channel

DESCRIPTION	GLUD															
	100° Diffused White Lens without Louver															
WATTS PER FOOT	5w (4.4 watts)								7w (7.5 watts)							
COLOR TEMPERATURE	22K	24K	27K	27D*	30K	30D*	35K	40K	57K	22K	24K	27K	30K	35K	40K	57K
LUMENS PER FOOT (lm/ft)	201	223	245	302	268	330	307	334	355	320	355	390	426	488	531	565
LUMENS PER WATT (lm/w)	46	50	56	63	61	69	70	76	81	44	48.5	53	58	67	73	77
CRI	85+	90+	95+	95+	95+	95+	85+	84	84	85+	90+	95+	95+	85+	84	84

DESCRIPTION	GLUDW															
	100° Diffused White Lens with White Louver															
WATTS PER FOOT	5w (4.4 watts)								7w (7.5 watts)							
COLOR TEMPERATURE	22K	24K	27K	27D*	30K	30D*	35K	40K	57K	22K	24K	27K	30K	35K	40K	57K
LUMENS PER FOOT (lm/ft)	141	156.5	172	212	188	231	215	234	249	224	248.5	273	298	342	371	395
LUMENS PER WATT (lm/w)	32	35.5	39	44	43	48	49	53	57	31	34	37	41	47	51	54
CRI	85+	90+	95+	95+	95+	95+	85+	84	84	85+	90+	95+	95+	85+	84	84

DESCRIPTION	GLUDB															
	100° Diffused White Lens with Black Louver															
WATTS PER FOOT	5w (4.4 watts)								7w (7.5 watts)							
COLOR TEMPERATURE	22K	24K	27K	27D*	30K	30D*	35K	40K	57K	22K	24K	27K	30K	35K	40K	57K
LUMENS PER FOOT (lm/ft)	88	98	108	132	118	145	135	146	156	140	155.5	171	187	214	232	247
LUMENS PER WATT (lm/w)	20	22	24	28	27	30	31	33	35	19	21	23	26	29	32	34
CRI	85+	90+	95+	95+	95+	95+	85+	84	84	85+	90+	95+	95+	85+	84	84

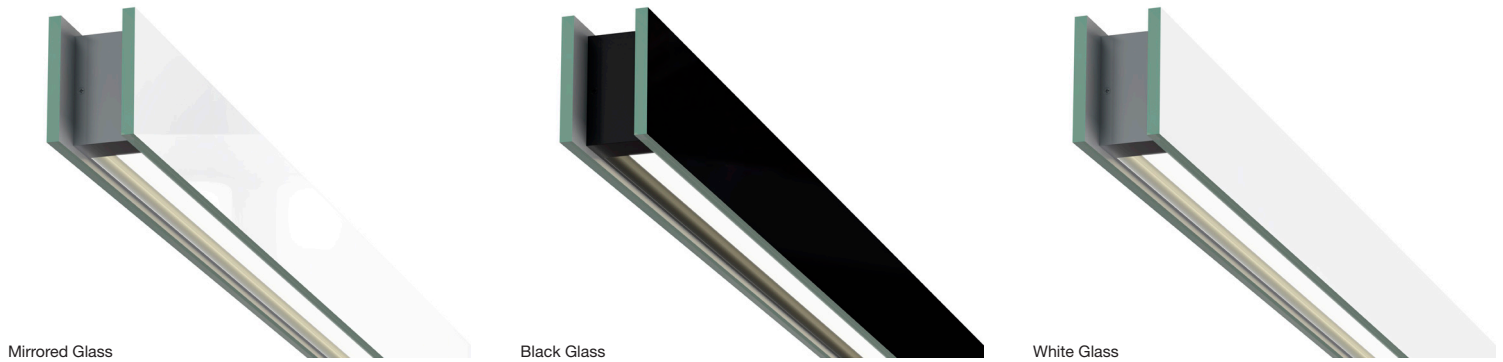

PROJECT	FIXTURE TYPE	DATE	
---------	--------------	------	--

Canopy: Sizes and wattages for the Glide Glass Up/Down - End Feed

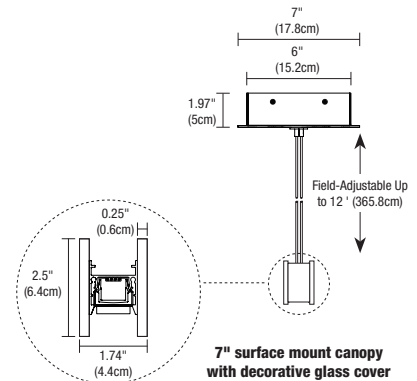
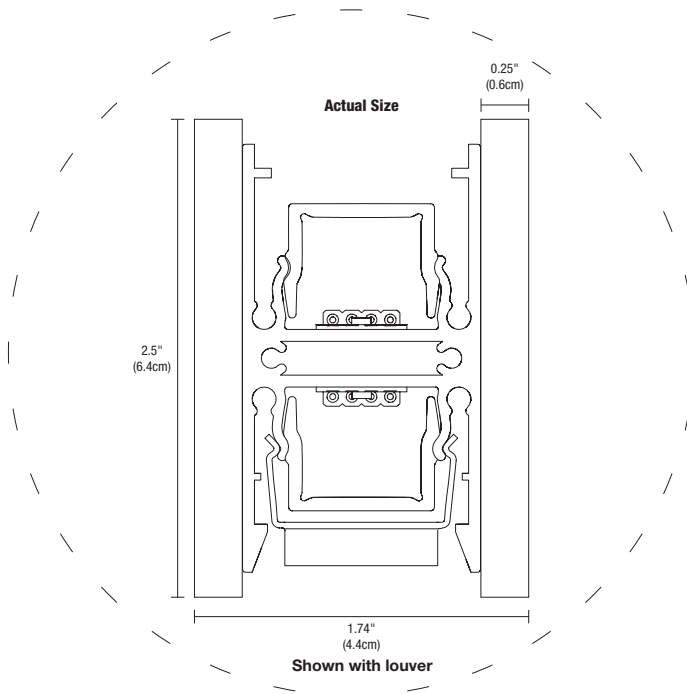
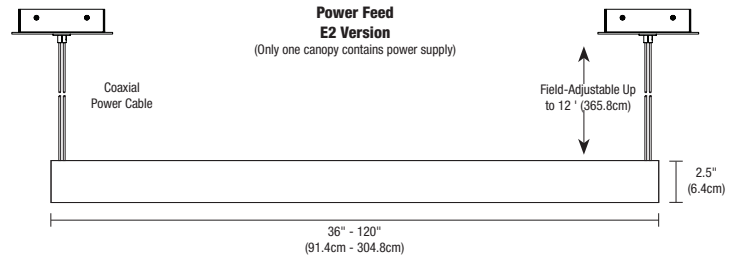
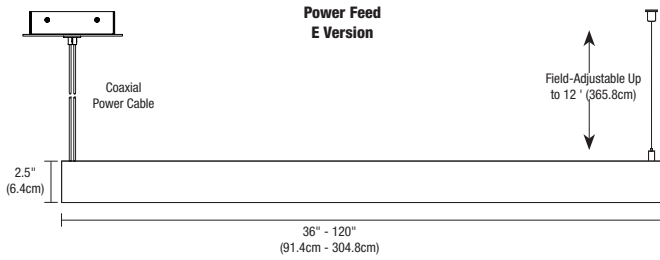

CANOPY CHART	
VERSION	7" CANOPY (SURFACE MOUNT)
7W (7.5) Lengths	Up to 120"
10W (9.6) Lengths	Up to 120"
12W (11.9) Lengths	104" - 120"

PROJECT	FIXTURE TYPE	DATE
---------	--------------	------

Wiring Diagram: Wiring diagram for dual ELV Dimmers

Application: ELV dimming for Glide Glass Up/Down, End feed

Dimming: Dimmable with (2) ELV dimmers: Legrand, Adorne ADTP703TU; Lutron: Diva DVELV-300P, Skylark SELV-300P, Maestro MAELV-600 and Radio Ra 2

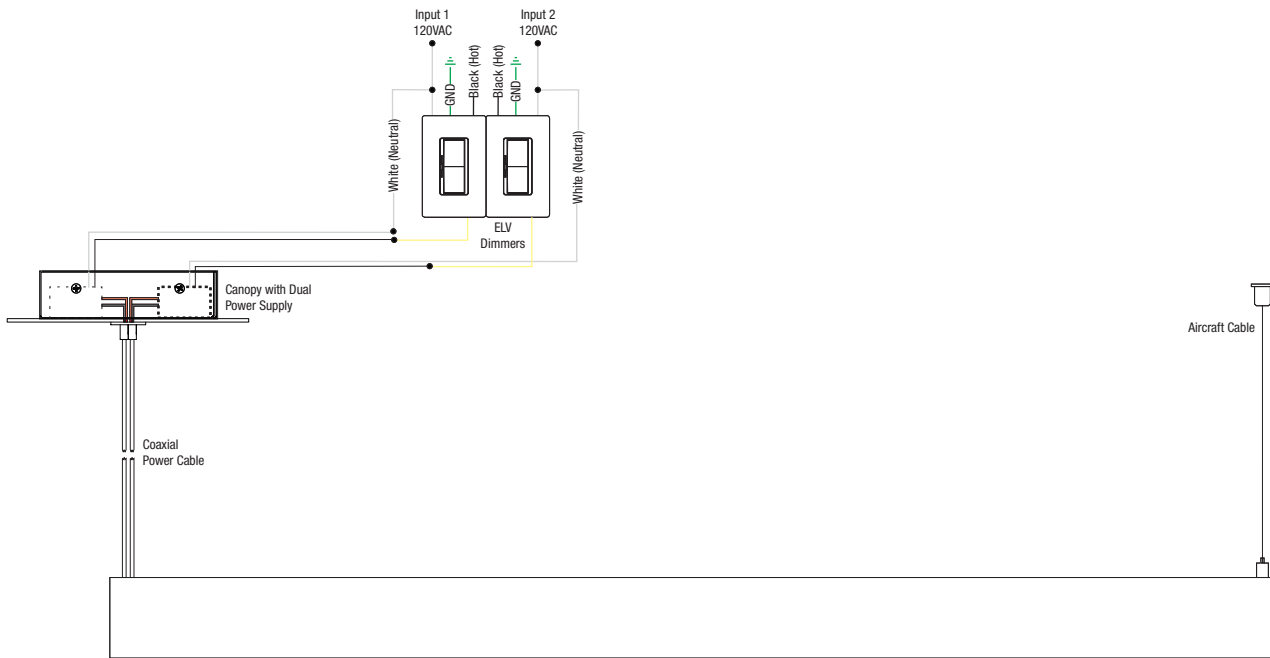

PROJECT		FIXTURE TYPE		DATE	
---------	--	--------------	--	------	--

SUSPENSION TM30 DATA

END FEED WITH POWER IN CANOPY

TM-30-15 DATA: The data below is for SS2C, SS5C, SS7C, and SS10C bare LED Soft Strips. Consistent color temperatures throughout a single strip and among multiple strips is possible through a 3 phase binning process in which each order is inspected with a color meter to ensure uniformity.

2200K | Rf: 83.9 | Rg: 94.9

Color Vector Graphic

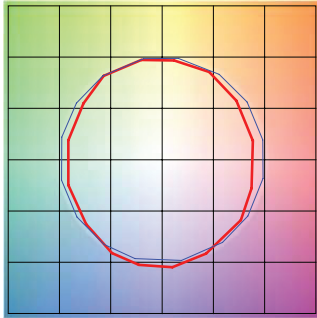

■ Test ■ Reference

HUE BIN	Rf	GRAPHIC SHIFTS %	
		CHROMA	HUE
1	78.8	-9.5%	1.3%
2	80.7	-7.8%	6.7%
3	78.2	-3.3%	9.4%
4	89.7	-2.8%	3.6%
5	93.2	-0.8%	2.6%
6	93.0	-0.6%	-0.7%
7	87.7	-5.9%	-3.5%
8	89.2	-6.8%	1.9%
9	83.4	-5.6%	6.0%
10	79.3	-3.7%	10.8%
11	81.4	2.9%	11.1%
12	84.9	5.3%	4.9%
13	88.1	4.9%	-10.1%
14	68.1	0.1%	-19.5%
15	86.0	-3.3%	-7.3%
16	76.4	-8.9%	-11.7%

2400K | Rf: 91.2 | Rg: 96.8

Color Vector Graphic

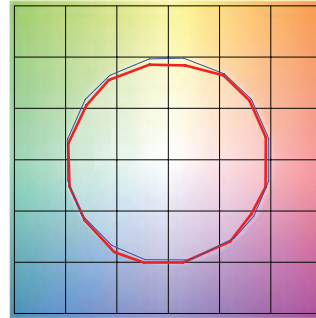

■ Test ■ Reference

HUE BIN	Rf	GRAPHIC SHIFTS %	
		CHROMA	HUE
1	92.0	-2.4%	1.5%
2	94.7	-2.1%	0.0%
3	95.4	-1.9%	-0.1%
4	88.7	-6.7%	-3.1%
5	92.8	-5.6%	1.0%
6	92.7	-3.4%	3.4%
7	89.9	-4.3%	4.1%
8	92.4	-1.4%	4.4%
9	89.0	-0.6%	5.8%
10	88.9	0.4%	6.2%
11	89.7	4.0%	5.4%
12	92.6	3.0%	-0.7%
13	90.9	1.1%	-7.0%
14	89.9	0.5%	-5.8%
15	92.1	-3.2%	0.1%
16	88.9	-1.7%	-6.3%

2700K | Rf: 87.7 | Rg: 96.1

Color Vector Graphic

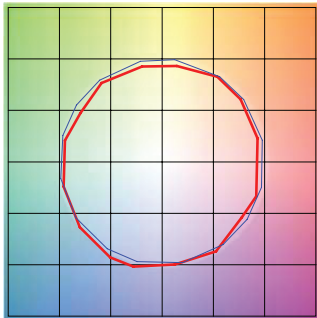

■ Test ■ Reference

HUE BIN	Rf	GRAPHIC SHIFTS %	
		CHROMA	HUE
1	88.0	-4.3%	2.6%
2	91.6	-2.4%	2.0%
3	93.7	-1.4%	1.9%
4	88.9	-5.6%	-3.1%
5	92.3	-5.5%	-0.5%
6	92.9	-3.5%	0.1%
7	84.5	-7.5%	4.6%
8	90.8	-3.0%	4.4%
9	84.5	-1.3%	8.3%
10	83.9	2.0%	9.8%
11	87.2	5.3%	7.1%
12	89.2	5.4%	-2.6%
13	88.7	0.3%	-7.8%
14	86.8	1.7%	-9.3%
15	87.6	-5.4%	-1.3%
16	83.6	-3.3%	-9.5%

3000K | Rf: 88.1 | Rg: 99.7

Color Vector Graphic

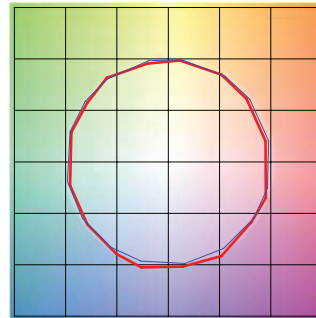

■ Test ■ Reference

HUE BIN	Rf	GRAPHIC SHIFTS %	
		CHROMA	HUE
1	92.5	-3.1%	0.3%
2	93.3	-2.3%	1.9%
3	90.9	-0.8%	3.9%
4	94.3	-1.1%	1.4%
5	92.5	-2.6%	1.5%
6	96.4	1.2%	-0.3%
7	92.6	-2.5%	-0.0%
8	96.9	-1.4%	0.2%
9	92.3	-1.8%	4.3%
10	86.6	-0.7%	7.0%
11	86.5	2.4%	8.2%
12	89.8	5.9%	1.7%
13	93.9	2.6%	-2.7%
14	89.4	5.1%	-5.8%
15	90.1	-0.1%	-4.7%
16	86.5	0.3%	-9.7%

3500K | Rf: 86.1 | Rg: 95.5

Color Vector Graphic

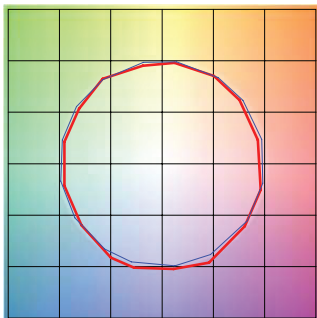

■ Test ■ Reference

HUE BIN	Rf	GRAPHIC SHIFTS %	
		CHROMA	HUE
1	90.8	-3.8%	0.3%
2	92.3	-2.8%	2.1%
3	89.7	-1.0%	4.3%
4	92.6	-1.4%	1.7%
5	91.8	-3.1%	1.3%
6	96.2	0.8%	-0.4%
7	92.9	-3.2%	0.2%
8	94.3	-2.5%	1.5%
9	90.4	-2.5%	5.2%
10	84.3	-1.4%	9.5%
11	83.1	3.5%	9.8%
12	88.2	4.8%	3.4%
13	94.0	2.7%	-2.0%
14	88.7	5.9%	-5.8%
15	88.7	0.7%	-5.9%
16	86.8	-0.7%	-6.7%

4000K | Rf: 87.6 | Rg: 96.8

Color Vector Graphic

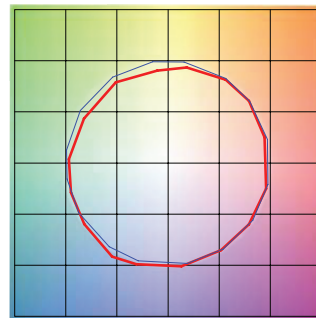

■ Test ■ Reference

HUE BIN	Rf	GRAPHIC SHIFTS %	
		CHROMA	HUE
1	88.9	-2.4%	2.5%
2	93.3	-0.4%	0.8%
3	94.8	-1.0%	-0.6%
4	87.9	-4.9%	-3.6%
5	85.3	-9.4%	-2.6%
6	90.2	-6.0%	0.2%
7	85.3	-7.6%	4.6%
8	83.7	-4.1%	8.2%
9	79.5	-1.1%	13.8%
10	78.6	1.5%	12.1%
11	83.5	6.4%	7.8%
12	90.9	3.6%	-1.1%
13	88.3	1.7%	-6.3%
14	91.9	-0.4%	-2.2%
15	84.5	-0.9%	-5.5%
16	84.7	-1.1%	-4.4%

PROJECT	FIXTURE TYPE	DATE
---------	--------------	------

SUSPENSION TM30 DATA

END FEED WITH POWER IN CANOPY

TM-30-15 DATA: The data below is for SS2C, SS5C, SS7C, and SS10C bare LED Soft Strips. Consistent color temperatures throughout a single strip and among multiple strips is possible through a 3 phase binning process in which each order is inspected with a color meter to ensure uniformity.

5700K | Rf: 80.3 | Rg: 91.5

Color Vector Graphic

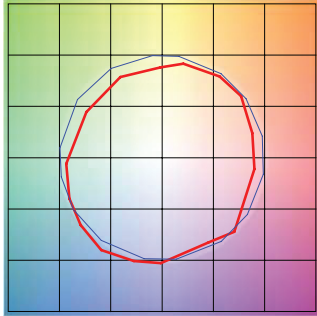

■ Test ■ Reference

HUE BIN	Rf	GRAPHIC SHIFTS %	
		CHROMA	HUE
1	75.4	-8.9%	4.7%
2	87.5	-2.6%	4.6%
3	90.7	-3.0%	-0.5%
4	83.2	-6.0%	-5.7%
5	76.2	-12.9%	-5.3%
6	81.4	-11.9%	-2.6%
7	74.8	-14.0%	5.1%
8	69.0	-9.0%	14.1%
9	72.6	-3.6%	22.2%
10	71.4	2.7%	16.1%
11	81.3	7.9%	5.3%
12	83.6	4.1%	-9.4%
13	78.4	0.7%	-15.3%
14	77.7	-6.2%	-11.0%
15	68.8	-1.3%	-21.2%
16	80.8	-9.6%	3.3%

2700D | Rf: 89.5 | Rg: 100.8

Color Vector Graphic

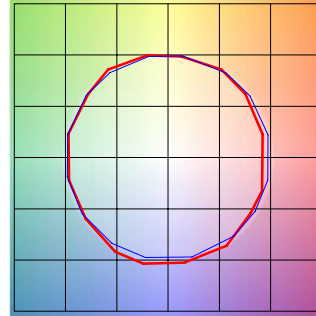

■ Test ■ Reference

HUE BIN	Rf	GRAPHIC SHIFTS %	
		CHROMA	HUE
1	88.8	-5.1%	1.4%
2	89.8	-2.7%	4.1%
3	87.2	0.3%	5.9%
4	92.3	-0.9%	1.0%
5	93.3	1.5%	1.7%
6	92.4	3.6%	-0.2%
7	92.2	-0.9%	-2.4%
8	96.7	-0.4%	-1.1%
9	92.3	-1.2%	3.7%
10	88.9	-0.0%	6.1%
11	86.4	5.1%	7.4%
12	88.2	6.3%	-0.9%
13	87.2	3.8%	-8.1%
14	84.2	3.8%	-11.0%
15	89.8	-2.6%	-4.3%
16	82.7	-3.4%	-11.1%

3000D | Rf: 89.8 | Rg: 101.4

Color Vector Graphic

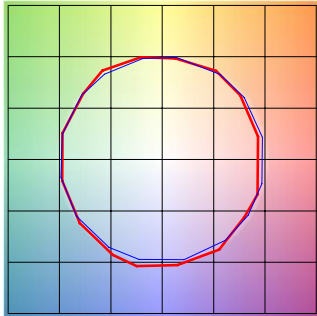

■ Test ■ Reference

HUE BIN	Rf	GRAPHIC SHIFTS %	
		CHROMA	HUE
1	90.2	-4.2%	1.5%
2	90.9	-2.0%	3.7%
3	87.9	0.8%	5.5%
4	92.1	-0.9%	0.6%
5	93.0	1.5%	1.6%
6	92.2	3.9%	-0.2%
7	92.1	-0.3%	-2.0%
8	96.7	0.0%	-1.2%
9	92.5	-0.6%	3.7%
10	88.3	1.1%	7.0%
11	87.2	4.1%	7.4%
12	87.2	6.7%	-1.0%
13	88.2	3.8%	-7.2%
14	85.3	4.3%	-9.9%
15	90.9	-2.2%	-3.6%
16	83.4	-2.2%	-11.2%

PROJECT	FIXTURE TYPE	DATE
---------	--------------	------