

CIRRUS MIYO TRIANGLE, WITH LIT CORNERS

24VDC LED MAKE-IT-YOUR-OWN SUSPENSION, STATIC WHITE & WARM DIM

DESIGNED BY GREGORY KAY | ASSEMBLED IN AMERICA

REV 02.19.21

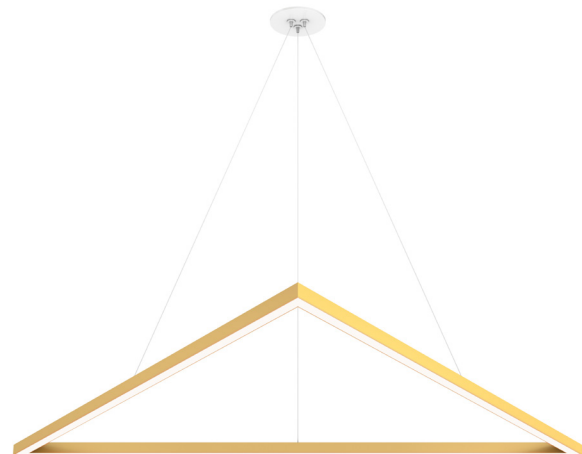
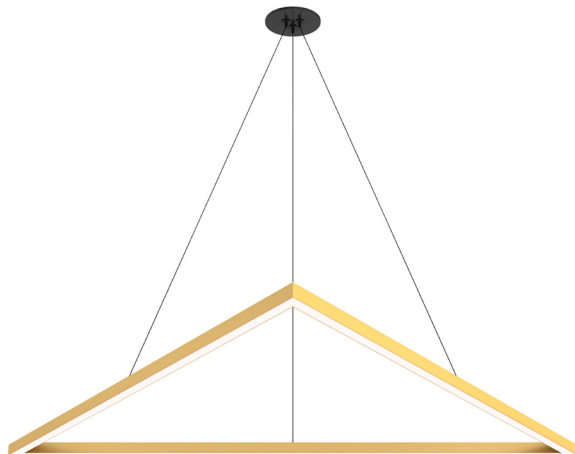

DESCRIPTION

Cirrus MIYO (Make-It-Your-Own) Triangle LED Suspension, Static White and Warm Dim joins a trio of clean linear channels to create a minimalist and geometric form designed by you. The Triangle MIYO Fixture is available in 5 watts or 7 watts per foot, features a Diffused Flat Standard or High Efficiency Lens with a 100° beam spread. Our MIYO family fixtures and systems are offered in multiple finishes, color temperatures including Warm Dim (**27D and 30D**), and lengths from 9" to 48" with high CRI values. Order **CSD_P** with power supplies included in the Canopy or **CSD_R** with remote power supplies sold separately. All these options allow you to become the fixture designer creating the perfect fixture for any unique space. Fixture includes a 5 year pro-rated warranty. For custom designs and layout assistance, email our design team design@PureEdgeLighting.com.

FINISHES



LENS

Diffused White Standard or High Efficiency Lens with 100° beam spread

LAMP

- Choose from 9 color temperatures from 2200K-5700K
- Warm Dim (optional): 2700K to 2000K (**27D**) or 3000K to 2000K (**30D**)
- 50,000 Hour Lamp Life

POWER & CANOPY SPECIFICATIONS

CSD_P: Power Supply in Canopy (Included)

- 4" Round Flush Canopy up to 50 watts, 8" Surface Mount Canopy up to 96 watts
 - Power: 120VAC-277VAC
 - Electronic Low Voltage Dimming (**ELV only**)*
- *ELV power supplies are not compatible with nLight, use only remote 0-10 volt or Uni driver power supplies

CSD_R: Remote Power Supplies (Sold Separately)

- 4" Round Flush Canopy
- Power: 24VDC, Class 2 wiring
- UNI Driver: Universal Dimming (**TRIAC, ELV, 0-10V**)
- Electronic Low Voltage Dimming (**ELV**)†
- 0-10V
- Lutron Hi-Lume®

*In-Wall Mounting Kits available for select power supplies

†ELV power supplies are not compatible with nLight, use only 0-10 volt or Universal driver power supplies

APPLICATIONS

Designed for Indoor Use Only. Ideal Applications include commercial, architectural, retail and residential spaces including offices, conference rooms, entrance halls, lobbies, Kitchens, Dining Rooms and more.

APPROVALS

Class 2 Wiring up to 100 watts, Damp Location Suitable, ETL listed. Title 24 with select power supplies, Made in America.

System	Type	Wattage Per Foot	Canopy	Nominal Size (Inches)	Color Temperature	Finish
CSDSP	T	5W	C	25	22K	SN
CSDSP Cirrus MIYO Diffused Lens Standard Efficiency with Power	T Triangle	5W 4.4 Watt 7W 7.5 Watt	C Center Feed E End Feed	STATIC WHITE 9, 12, 14, 16, 19, 21, 24, 26, 28, 31, 33, 36, 38, 40, 43, 45, 48 WARM DIM 11, 14, 17, 20, 23, 26, 29, 32, 35, 38, 41, 44, 47 See pg. 4 for exact lengths.	22K 2200K Amber White 24K 2400K Very Warm White 27K 2700K Incandescent White 27D 2700K Warm Dim (5W only) 30K 3000K Warm White 30D 3000K Warm Dim (5W only) 35K 3500K Neutral White 40K 4000K Cool White 57K 5700K Daylight White	BK Satin Black BZ Antique Bronze CH Chrome SN Satin Nickel WH White BB Satin Brass with Black Canopy BW Satin Brass with White Canopy
CSDHP Cirrus MIYO Diffused Lens High Efficiency with Power						
CSDSR* Cirrus MIYO Standard Efficiency Diffused Lens, Remote Power, 4" Canopy						
CSDHR* Cirrus MIYO High Efficiency Diffused Lens, Remote Power, 4" Canopy						

*Power Canopies: 4" Round Flush Canopy up to 50 watts, 8" Surface Mount Canopy up to 96 watts

PROJECT		FIXTURE TYPE		DATE	
---------	--	--------------	--	------	--

CIRRUS MIYO TRIANGLE, WITH LIT CORNERS

24VDC LED MAKE-IT-YOUR-OWN SUSPENSION, STATIC WHITE & WARM DIM

FINISHES Finishes available for the Cirrus MIYO Triangle LED Suspension with Lit Corners, Static White & Warm Dim



CSDSP-T-5W-C-26-22K-CH

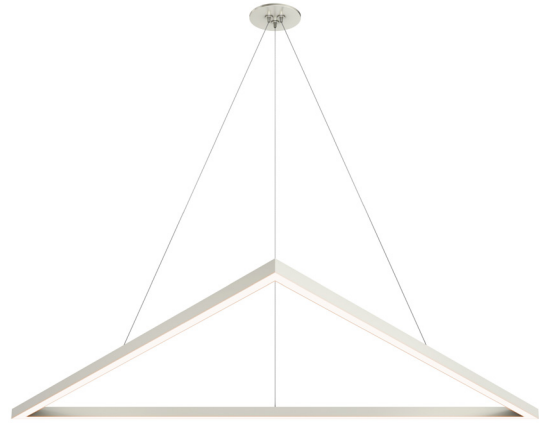

CSDSP-T-5W-C-26-22K-SN

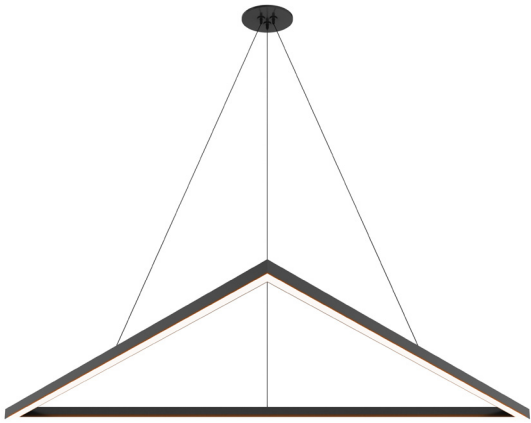

CSDSP-T-5W-C-26-22K-BK

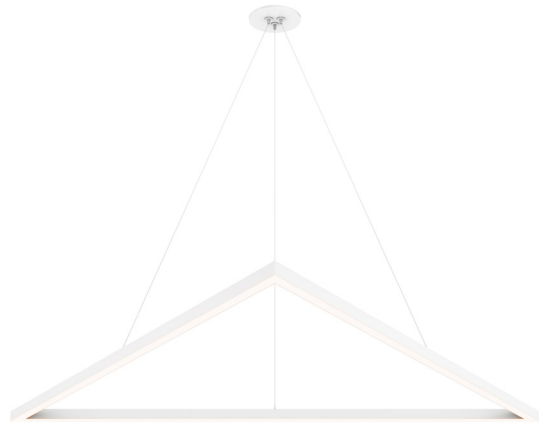

CSDSP-T-5W-C-26-22K-WH

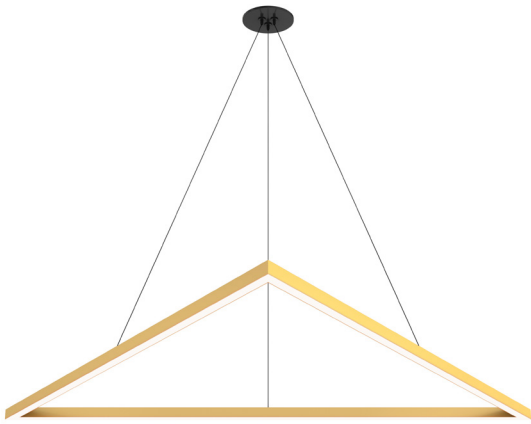

CSDSP-T-5W-C-26-22K-BB

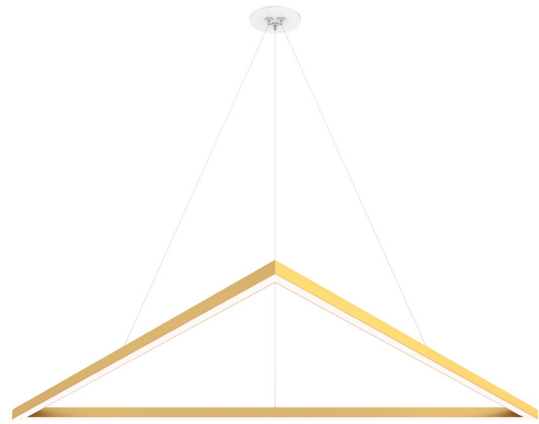

CSDSP-T-5W-C-26-22K-BW

PROJECT		FIXTURE TYPE		DATE	
---------	--	--------------	--	------	--

CIRRUS MIYO TRIANGLE, WITH LIT CORNERS

24VDC LED MAKE-IT-YOUR-OWN SUSPENSION, STATIC WHITE & WARM DIM

LAMP DATA Lamp Data for the Cirrus MIYO Triangle LED Suspension with Power

CSDSP																
DESCRIPTION	STANDARD EFFICIENCY, 100° DIFFUSED WHITE LENS WITHOUT LOUVER															
WATTS PER FOOT	5W (4.4 watts)									7W (7.5 watts)						
COLOR TEMPERATURE	22K	24K	27K	27D*	30K	30D*	35K	40K	57K	22K	24K	27K	30K	35K	40K	57K
LUMENS PER FOOT (lm/ft)	226	251	275	341	301	341	345	375	399	369	409	450	492	563	612	652
LUMENS PER WATT (lm/w)	51	57	62	71	68	71	78	85	90	51	56	62	68	77	84	89
CRI	85+	90+	95+	93+	95+	92+	85+	85+	85+	85+	90+	95+	95+	85+	85+	85+

*27D, 30D - Warm Dim (4.8 Watts)

CSDHP																
DESCRIPTION	HIGH EFFICIENCY, 100° DIFFUSED WHITE LENS WITHOUT LOUVER															
WATTS PER FOOT	5W (4.4 watts)									7W (7.5 watts)						
COLOR TEMPERATURE	22K	24K	27K	27D*	30K	30D*	35K	40K	57K	22K	24K	27K	30K	35K	40K	57K
LUMENS PER FOOT (lm/ft)	271	301	330	409	361	409	413	450	478	443	491	540	590	676	735	782
LUMENS PER WATT (lm/w)	62	68	75	85	82	85	94	102	108	61	67	74	81	93	100	107
CRI	85+	90+	95+	93+	95+	92+	85+	85+	85+	85+	90+	95+	95+	85+	85+	85+

*27D, 30D - Warm Dim (4.8 Watts)

8" CIRRUS LUMINAIRE BEAM ANGLE & FOOT CANDLE

5 Watt 100°	
Distance	Foot Candles
1'	122
1.5'	80
2'	59
3'	38
4'	27
5'	20
6'	15
7'	12
8'	10

7 Watt 100°	
Distance	Foot Candles
1'	200
1.5'	131
2'	96
3'	62
4'	45
5'	33
6'	26
7'	21
8'	18

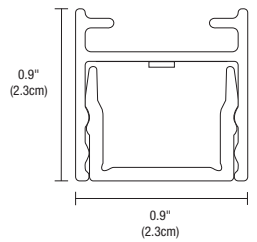
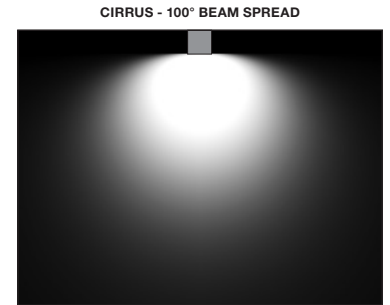
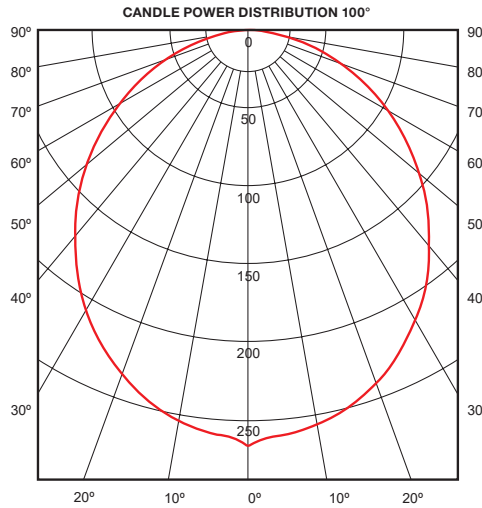

PROJECT	FIXTURE TYPE	DATE
---------	--------------	------

CIRRUS MIYO TRIANGLE, WITH LIT CORNERS

24VDC LED MAKE-IT-YOUR-OWN SUSPENSION, STATIC WHITE & WARM DIM

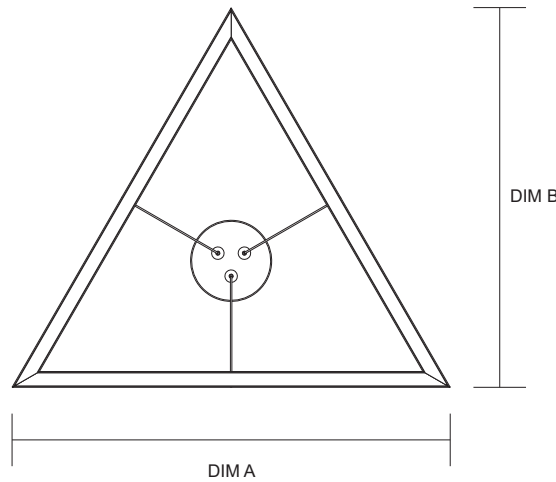

LENGTH CHART Actual Lengths for Cirrus MIYO Triangle with Lit Corners, Static White & Warm Dim

22K, 24K, 27K, 30K, 35K, 40K & 57K								
Nominal Length (Inches)	Dim A (Inches)	Dim B (Inches)	Total Wattage (5W)	Canopy (5W)	Total Lumens 3000K (5W)	Total Wattage (7W)	Canopy (5W)	Total Lumens 3000K (7W)
9	9.14	7.91	9	4" Round Flush	470	14	4" Round Flush	738
12	11.54	9.99	12	4" Round Flush	626	18	4" Round Flush	984
14	13.94	12.07	15	4" Round Flush	783	23	4" Round Flush	1230
16	16.34	14.15	18	4" Round Flush	940	27	4" Round Flush	1476
19	18.74	16.23	21	4" Round Flush	1096	32	4" Round Flush	1722
21	21.14	18.31	24	4" Round Flush	1253	36	4" Round Flush	1968
24	23.54	20.38	27	4" Round Flush	1409	41	4" Round Flush	2214
26	25.94	22.46	30	4" Round Flush	1566	45	4" Round Flush	2460
28	28.34	24.54	33	4" Round Flush	1723	50	8" Surface Mount	2706
31	30.74	26.62	36	4" Round Flush	1879	54	8" Surface Mount	2952
33	33.14	28.70	39	4" Round Flush	2036	59	8" Surface Mount	3198
36	35.54	30.78	42	4" Round Flush	2192	63	8" Surface Mount	3444
38	37.94	32.85	45	4" Round Flush	2349	68	8" Surface Mount	3690
40	40.34	34.93	48	4" Round Flush	2506	72	8" Surface Mount	3936
43	42.74	37.01	51	8" Surface Mount	2662	77	8" Surface Mount	4182
45	45.14	39.09	54	8" Surface Mount	2819	81	8" Surface Mount	4428
48	47.54	41.17	57	8" Surface Mount	2975	86	8" Surface Mount	4674

WARM DIM (27D & 30D)					
Nominal Length (A) (Inches)	Dim A (Inches)	Dim B (Inches)	Total Wattage (5W)	Canopy (5W)	Total Lumens 3000K (5W)
11	10.94	9.47	12	4" Round Flush	583
14	13.94	12.07	15	4" Round Flush	777
17	16.94	14.67	19	4" Round Flush	971
20	19.94	17.27	23	4" Round Flush	1166
23	22.94	19.86	27	4" Round Flush	1360
26	25.94	22.46	30	4" Round Flush	1554
29	28.94	25.06	34	4" Round Flush	1748
32	31.94	27.66	38	4" Round Flush	1943
35	34.94	30.26	42	4" Round Flush	2137
38	37.94	32.85	45	4" Round Flush	2331
41	40.94	35.45	49	4" Round Flush	2525
44	43.94	38.05	53	8" Surface Mount	2720
47	46.94	40.65	57	8" Surface Mount	2914

PROJECT		FIXTURE TYPE		DATE	
---------	--	--------------	--	------	--

CIRRUS MIYO TRIANGLE, WITH LIT CORNERS

24VDC LED MAKE-IT-YOUR-OWN SUSPENSION, STATIC WHITE & WARM DIM

DRAWINGS Dimension drawings for the Cirrus MIYO Triangle LED Suspension with Lit Corners, Static White & Warm Dim, Center Feed

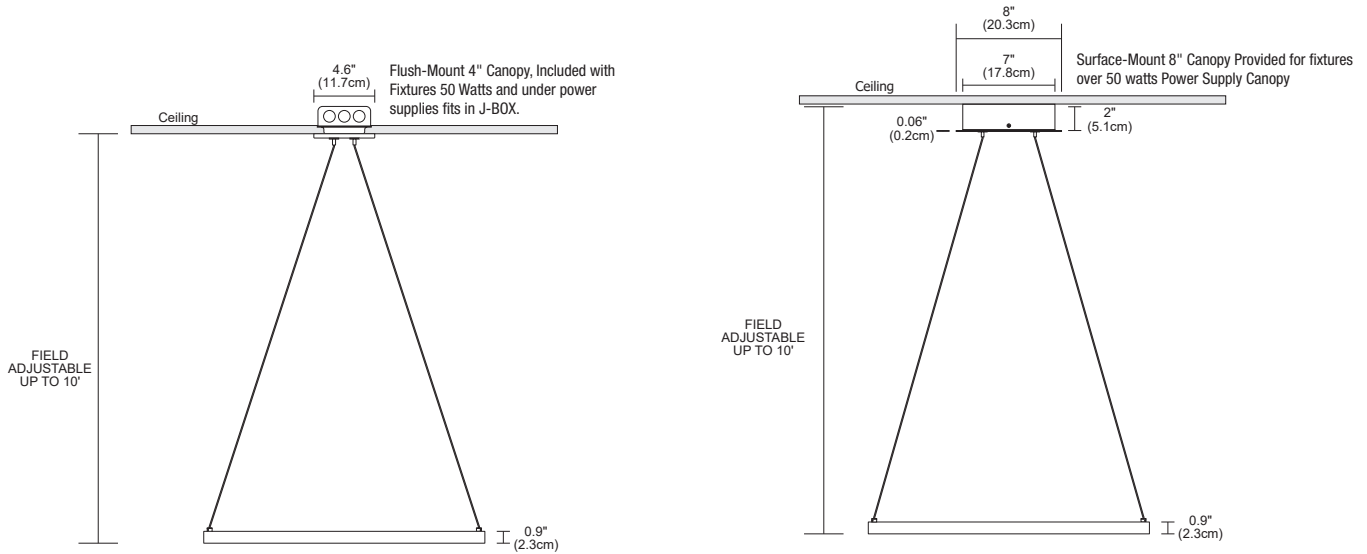

DRAWINGS Dimension drawings for the Cirrus MIYO Triangle Suspension with Lit Corners, Static White & Warm Dim, End Feed

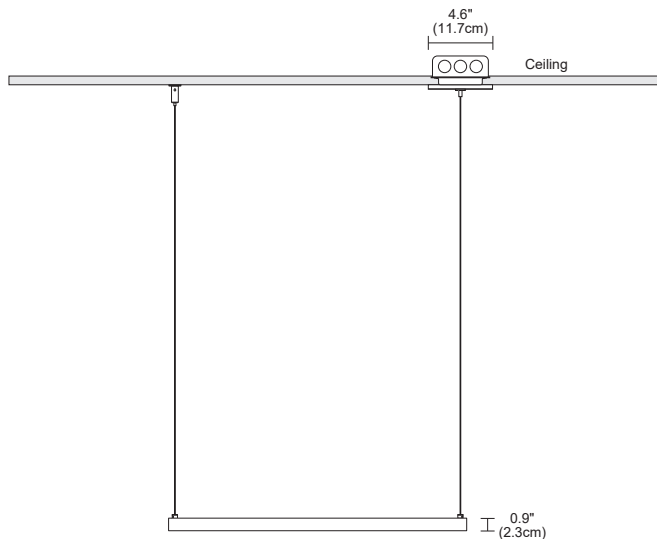

PROJECT	FIXTURE TYPE	DATE

WIRING DIAGRAM Wiring Diagram for 24VDC Static White and Warm Dim - Dynamic Color Changing, with ELV Dimmer End Feed

APPLICATION ELV dimming for Cirrus MIYO Triangle LED Power Suspension, End Feed Canopy, Static White and Warm Dim - Dynamic Color Changing

DIMMING Dimmable with ELV dimmer: Legrand, Adorne ADTP703TU
Lutron: Diva DVELV-300P, Skylark SELV-300P, Maestro MAELV-600 and Radio Ra 2

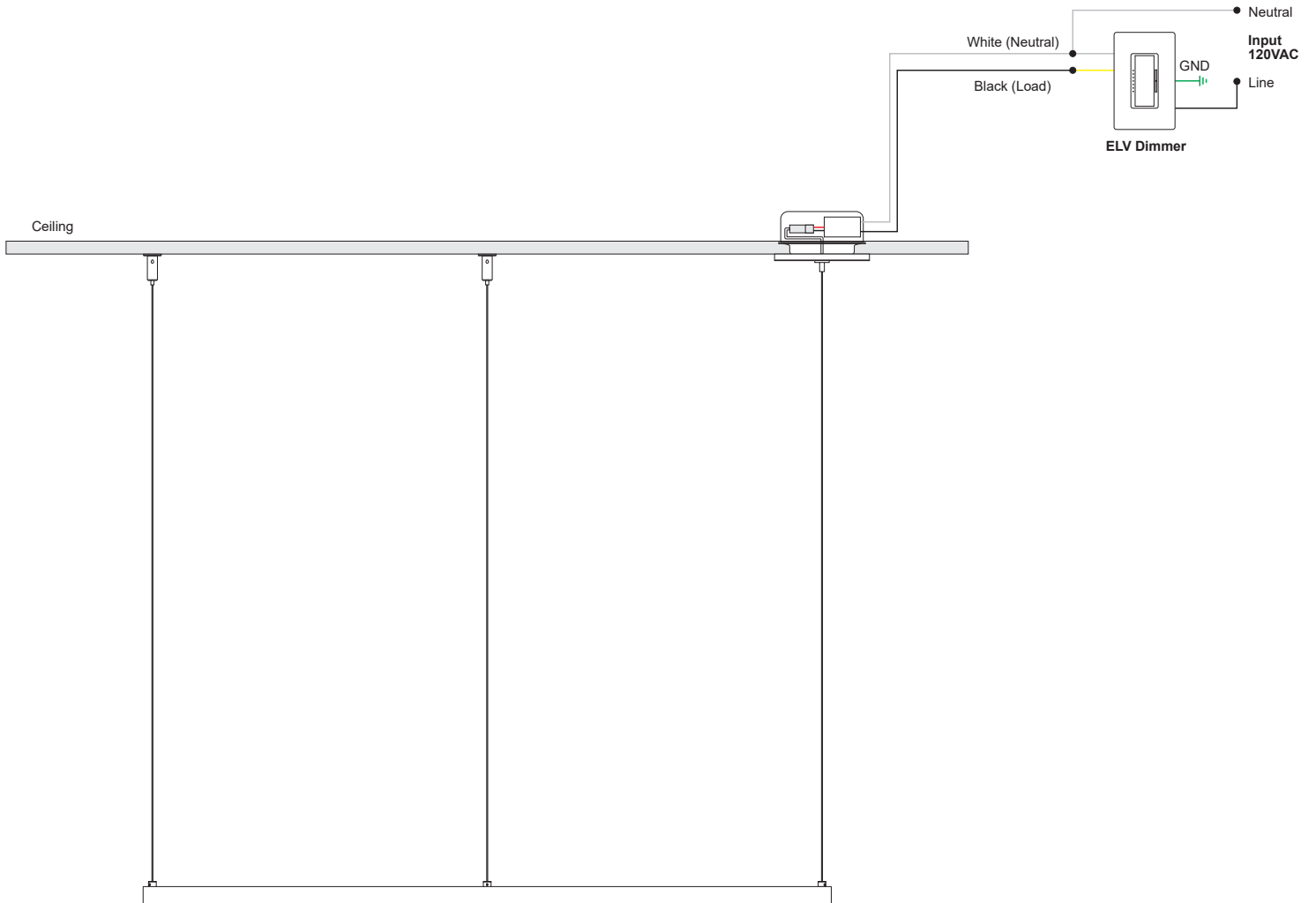

PROJECT	FIXTURE TYPE	DATE

INDOOR CONSTANT VOLTAGE REMOTE POWER SUPPLIES

24VDC, UNI - UNIVERSAL DIMMING WITH ELV, TRIAC, & 0-10V

REV 02.19.21

UNIVERSAL POWER SUPPLIES & RECOMMENDED DIMMERS				
ORDERING CODE	PSB-40W-UNI-24VDC 	PSB-60W-UNI-24VDC 	PSB-2X40W-UNI-24VDC 	PSB-2X60W-UNI-24VDC
SPECIFICATIONS				
MAXIMUM LOAD	40W	60W	2X40W	2X60W
INPUT VOLTAGE	120-277VAC	120-277VAC	120-277VAC	120-277VAC
OUTPUT VOLTAGE	24VDC	24VDC	24VDC	24VDC
DIMENSIONS	12.4" X 3.12" X 2.18"	12.4" X 3.12" X 2.18"	12.15" X 6.48" X 2.18"	12.15" X 6.48" X 2.18"
CLASSIFICATION	CLASS 2	CLASS 2	CLASS 2	CLASS 2
IN-WALL MOUNTING	PSB-40W-UNI-24VDC-IW	PSB-60W-UNI-24VDC-IW	PSB-2X40W-UNI-24VDC-IW	PSB-2X60W-UNI-24VDC-IW
UNIVERSAL POWER SUPPLIES & RECOMMENDED DIMMERS				
ORDERING CODE	PSB-96W-UNI-24VDC 	PSB-2X96W-UNI-24VDC 	PSB-3X96W-UNI-24VDC 	PSB-4X96W-UNI-24VDC
SPECIFICATIONS				
MAXIMUM LOAD	96W	2X96W	3X96W	4X96W
INPUT VOLTAGE	120-277VAC	120-277VAC	120-277VAC	120-277VAC
OUTPUT VOLTAGE	24VDC	24VDC	24VDC	24VDC
DIMENSIONS	12.4" X 3.12" X 2.18"	12.15" X 6.48" X 2.18"	14" X 10" X 3"	17" X 13" X 3"
CLASSIFICATION	CLASS 2	CLASS 2	CLASS 2	CLASS 2
IN-WALL MOUNTING	PSB-96W-UNI-24VDC-IW	PSB-2X96W-UNI-24VDC-IW	NA	NA
ELV DIMMING & CONTROLS				
LUTRON DIVA: DVELV-300P	•	•	•	•
LUTRON SKYLARK: SELV-300P	•	•	•	•
LUTRON RADIO RA2: RRD-6NA	•	•	•	•
LUTRON MAESTRO: MAELV-600	•	•	•	•
LEGRAND ADORNE: ADTP-703TUM4	•	•	•	•
0-10 DIMMING & CONTROLS				
PHILIPS SUNRISE: SR1200ZTUNV	•	•	•	•
LUTRON DIVA: DVTW-WH, DVSTV-WH	•	•	•	•
LUTRON NOVA T: NTSTV-DV-XX	•	•	•	•
LUTRON GRAFIX EYE QS: QSGRJ-XP	•	•	•	•
LUTRON RADIO RA2: RRD-10ND	•	•	•	•
LEVITON: LEV40050	•	•	•	•
LEVITON IP710-LFZ	•	•	•	•
LEGRAND: ADPD4FBL3P2W4	•	•	•	•
TRIAC DIMMING & CONTROLS				
LUTRON SKYLARK: S2-L-WH	•	•	•	•
LUTRON DIVA DVLV-600P-WH	•	•	•	•
LUTRON DIVA DVLV-603P-WH	•	•	•	•
LUTRON MAESTRO MALV-600-WH	•	•	•	•
LUTRON MAESTRO MALV-1000-WH	•	•	•	•
LUTRON MAESTRO MA-R-XX	•	•	•	•

- Flicker free dimming
- Aluminum casing for optimal heat dissipation
- Isolated output power per NEC and UL safety requirements
- UL & ETL recognized/ listed, meets UL 8750, 1310 requirements
- Auto-reset: short circuit, overload and thermal protection
- Class 2 power supply
- Efficient, High power factor > 0.90
- The Solid State Constant Voltage Uni-Power Supply is compatible with most commercially available Dimmers:
 - Triac Dimmer : (Forward Phase) Typically used for the dimming of Incandescent and Low Voltage Magnetic Transformers
 - ELV Dimmer : (Reverse Phase) Dimming of Electronic Low Voltage Transformers and Power Supply's used for LED lighting
 - 0-10 Dimmer : Dims the Low Voltage side of a 0-10 volt power supply commonly used in large scale lighting or commercial applications.
- The Uni-Power Supply is recommended with any Siemens/Murray brand of arc fault breaker to overcome the issues with tripping the breakers with an ELV LED Low Voltage Drivers.

PROJECT		FIXTURE TYPE		DATE	
---------	--	--------------	--	------	--

IN WALL MOUNTING OPTIONS

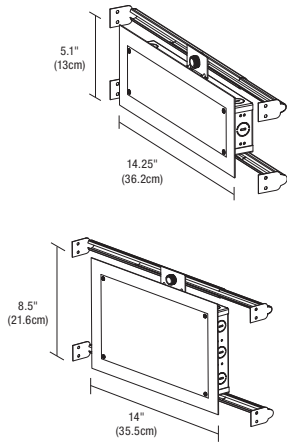

In-Wall Mounting Kit: Includes power supply, box cover and stud hangers for installing Junction Box in wall. Select "IW" in the options section of compatible power supply ordering codes if an In-Wall Mounting Kit is needed.

Ordering Codes 5.1 x 14.25 inch: PSB-40W-UNI-24VDC-IW
PSB-60W-UNI-24VDC-IW
PSB-96W-UNI-24VDC-IW

Ordering Codes 8.5 x 14.25 inch: PSB-2X40W-UNI-24VDC-IW
PSB-2X60W-UNI-24VDC-IW
PSB-2X96W-UNI-24VDC-IW

WIRING DIAGRAMS UNIVERSAL POWER SUPPLY

Application: ELV dimming for Static White and Warm Dim

Dimming: Dimmable with ELV dimmer: Legrand, Adorne ADTP703TU; Lutron: Diva DVELV-300P, Skylark SELV-300P, Maestro MAELV-600 and Radio Ra 2

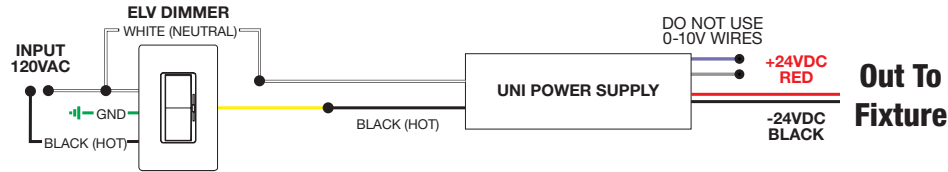





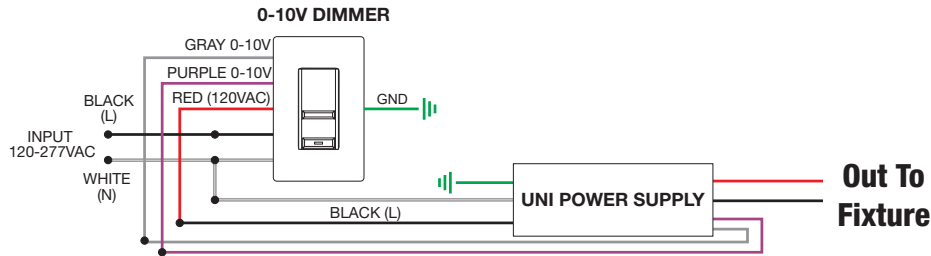

Application: 0-10V dimming for Static White and Warm Dim

Dimming: Dimmable with 0-10V dimmer: Philips Sunrise: SR1200ZTUNV; Lutron Diva: DVTV-WH, DVSTV-WH; Lutron Nova T: NTSTV-DV-XX; Lutron Grafix EYE QS: QSGRJ-XP; Lutron Radio Ra2: RRD-10ND; Leviton: LEV40050; Leviton IP710-LFZ; Legrand: ADPD4FBL3P2W4



PROJECT		FIXTURE TYPE		DATE	
---------	--	--------------	--	------	--

0-10 VOLT (010) POWER SUPPLIES & RECOMMENDED DIMMERS†				
ORDERING CODE	PSB-25W-010-24VDC 	PSB-60W-010-24VDC 	PSB-96W-010-24VDC 	PSB-2X96W-010-24VDC 
SPECIFICATIONS				
MAXIMUM LOAD	25W	60W	96W	2X96W
INPUT VOLTAGE	120VAC	120-277VAC	120-277VAC	120-277VAC
OUTPUT VOLTAGE	24VDC	24VDC	24VDC	24VDC
DIMENSIONS	12.4" X 3.12" X 2.18"	12.4" X 3.12" X 2.18"	12.4" X 3.12" X 2.18"	12.15" X 6.48" X 2.18"
CLASSIFICATION	CLASS 2	CLASS 2	CLASS 2	CLASS 2
IN-WALL MOUNTING	PSB-25W-010-24VDC-IW	PSB-60W-010-24VDC-IW	PSB-96W-010-24VDC-IW	PSB-2X96W-010-24VDC-IW

0-10 VOLT (010) POWER SUPPLIES & RECOMMENDED DIMMERS†			
ORDERING CODE	PSB-3X96W-010-24VDC 	PSB-4X96W-010-24VDC 	
SPECIFICATIONS			
MAXIMUM LOAD	3X96W	4X96W	
INPUT VOLTAGE	120-277VAC	120-277VAC	
OUTPUT VOLTAGE	24VDC	24VDC	
DIMENSIONS	14" X 10" X 3"	17" X 13" X 3"	
CLASSIFICATION	CLASS 2	CLASS 2	
IN-WALL MOUNTING	N/A	N/A	
DIMMING & CONTROLS			
PHILIPS SUNRISE: SR1200ZTUNV	•	•	
LUTRON DIVA: DVTV-WH, DVSTV-WH	•	•	
LUTRON NOVA T: NTSTV-DV-XX	•	•	
LUTRON GRAFIX EYE QS: QSGRJ-XP	•	•	
LUTRON RADIO RA2: RRD-10ND	•	•	
LEVITON: LEV40050	•	•	
LEVITON IP710-LFZ	•	•	
LEGRAND: ADPD4FBL3P2W4	•	•	

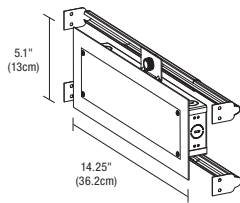

5.1 x 14.25 inch In-Wall Mounting Kit: Includes power supply, box cover and stud hangers for installing Junction Box in wall. Select "IW" in the options section of compatible power supply ordering codes if an In-Wall Mounting Kit is needed.

Ordering Codes: PSB-25W-010-24VDC-IW, PSB-60W-010-24VDC-IW, PSB-96W-010-24VDC-IW

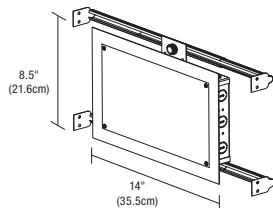

8.5 x 14 inch In-Wall Mounting Kit: Includes power supply, box cover and stud hangers for installing Junction Box in wall. Select "IW" in the options section of compatible power supply ordering codes if an In-Wall Mounting Kit is needed.

Ordering Codes: PSB-2X96W-010-24VDC-IW

PROJECT		FIXTURE TYPE		DATE	
---------	--	--------------	--	------	--

SAMPLE WIRING DIAGRAMS 24VDC 010

Application: 0-10V Dimming Applications For Static White and Warm Dim 0-10V Dual Dimming.

Dimming: Dimmable with 0-10V dimmers: Signify (Phillips) Sunrise: SR1200ZTUNV, Leviton Dimmers: LEV40050, IP710-LFZ, *IP710-DLZ *(Built in LED locator light) Legrand Dimmer: ADPD4FBL3P2W4 Lutron Systems: Lutron GRAFIX Eye QS Main Unit (with DRX-TVI) Radio Ra2 (with GRX-TVI)

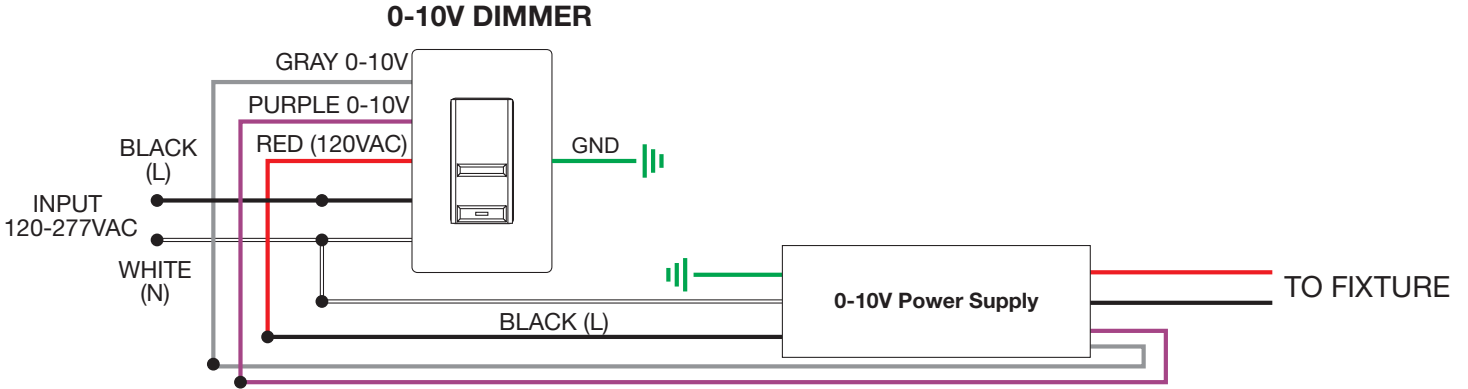

PROJECT		FIXTURE TYPE		DATE	
---------	--	--------------	--	------	--

ELECTRONIC LOW-VOLTAGE (ELV) POWER SUPPLIES & RECOMMENDED DIMMERS ^{†‡}				
ORDERING CODES	PSB-60L-ELV-24VDC 	PSB-60W-ELV-24VDC 	PSB-2X60W-ELV-24VDC 	PSB-100W-ELV-24VDC
SPECIFICATIONS				
MAXIMUM LOAD	60W NON-IC, 50W-IC (FITS IN JBOX)	60W	2X60W	96W
INPUT VOLTAGE	120VAC	120VAC	120VAC	120VAC
OUTPUT VOLTAGE	24VDC	24VDC	24VDC	24VDC
DIMENSIONS	2.25" X 1.25" X 0.83"	8.125" X 2" X 1.75"	12.15" X 6.48" X 2.18"	9.25" X 3.5" X 2"
CLASSIFICATION	CLASS 2	CLASS 2	CLASS 2	CLASS 2
IN WALL MOUNTING	N/A	PSB-60W-ELV-24VDC-IW	PSB-2X60W-ELV-24VDC-IW	PSB-100W-ELV-24VDC-IW
ELECTRONIC LOW-VOLTAGE (ELV) POWER SUPPLIES & RECOMMENDED DIMMERS ^{†‡}				
ORDERING CODES	PSB-2X100W-ELV-24VDC 	PSB-3X100W-ELV-24VDC 	PSB-4X100W-ELV-24VDC 	
SPECIFICATIONS				
MAXIMUM LOAD	2X96W	3X96W	4X96W	
INPUT VOLTAGE	120VAC	120VAC	120VAC	
OUTPUT VOLTAGE	24VDC	24VDC	24VDC	
DIMENSIONS	12.15" X 6.48" X 2.18"	14" X 10" X 3"	17" X 13" X 3"	
CLASSIFICATION	CLASS 2	CLASS 2	CLASS 2	
IN WALL MOUNTING	PSB-2X100W-ELV-24VDC-IW	N/A	N/A	
DIMMING AND CONTROLS				
LUTRON DIVA: DVELV-300P	•	•	•	
LUTRON SKYLARK: SELV-300P	•	•	•	
LUTRON RADIO RA2: RRD-6NA	•	•	•	
LUTRON MAESTRO: MAELV-600	•	•	•	
LEGRAND ADORNE: ADTP-703TUM4	•	•	•	

[†]22K - 57K color temperatures are compatible with 0-10V, ELV, and Lutron Hi-Lume® Power Supplies. Warm Dim (27D, 30D) color temperatures are only compatible with ELV power supplies. Tunable White color temperature is compatible with 0-10V, ELV, DMX, and Lutron Hi-Lume® Power Supplies. Dynamic Color (RGB, RGB+W) and Static Color (Amber, Blue, Green, or Red) are compatible with DMX Power Supplies.

[‡]Electrical Panels using Seimens/Murray AFCI breakers are not compatible with this ELV transformer. Use 0-10 Volt power supplies with this breaker

With N-Lite Dimming Do Not use ELV power supplies, use only 0-10 volt or Uni drivers power supplies

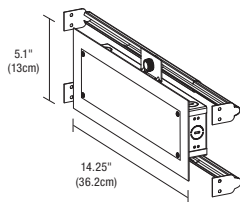

5.1 x 14.25 inch In-Wall Mounting Kit: Includes power supply, box cover and stud hangers for installing Junction Box in wall. Select "IW" in the options section of compatible power supply ordering codes if an In-Wall Mounting Kit is needed.

Ordering Codes: PSB-60W-ELV-24VDC-IW
PSB-100W-ELV-24VDC-IW

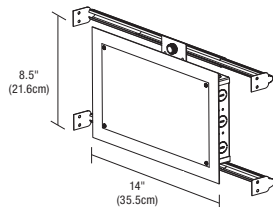

8.5 x 14 inch In-Wall Mounting Kit: Includes power supply, box cover and stud hangers for installing Junction Box in wall. Select "IW" in the options section of compatible power supply ordering codes if an In-Wall Mounting Kit is needed.

Ordering Codes: PSB-2X60W-ELV-24VDC-IW
PSB-2X100W-ELV-24VDC-IW

PROJECT		FIXTURE TYPE		DATE	
---------	--	--------------	--	------	--

SAMPLE WIRING DIAGRAMS 24VDC ELV

Application: ELV dimming for Static White

Dimming: Dimmable with ELV dimmer: Legrand, Adorne ADTP703TU; Lutron: Diva DVELV-300P, Skylark SELV-300P, Maestro MAELV-600 and Radio Ra 2

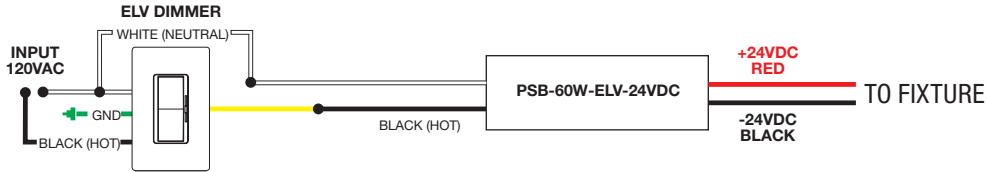

Application: ELV dimming for Static White

Dimming: Dimmable with ELV dimmer: Legrand, Adorne ADTP703TU; Lutron: Diva DVELV-300P, Skylark SELV-300P, Maestro MAELV-600 and Radio Ra 2

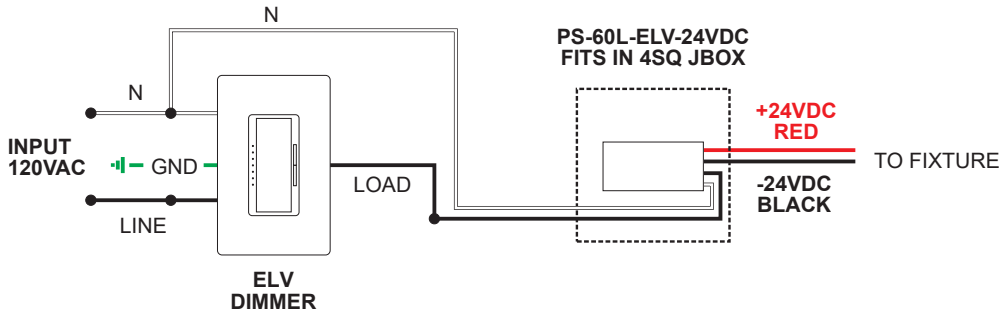

PROJECT		FIXTURE TYPE		DATE	
---------	--	--------------	--	------	--

LUTRON HI-LUME® PREMIER .1% ECOSYSTEM®†

	L3D0-96W24V-U	2-WIRE ECOSYSTEM LTEA4U1UKL-CV240	3-WIRE ECOSYSTEM L3DA4U1UKL-CV240
ORDERING CODES			
SPECIFICATIONS			
MAXIMUM LOAD	96W	5W-40W	5W-40W
INPUT VOLTAGE	120-277VAC	120-277VAC	120-277VAC
OUTPUT VOLTAGE	24VDC	24VDC	24VDC
DIMENSIONS	10.5" X 5.5" X 2"	4" X 4.89" X 2.62"	4" X 4.89" X 2.62"
CLASSIFICATION	CLASS 2	CLASS 2	CLASS 2
DIMMING AND CONTROLS			
RADIO RA2	•	•	•
HOMEWORKS QS	•	•	•
PHPM-3F-120	•	•	•
PHPM-3F-DV	•	•	•
BCI-0-10	•	•	•

†24K - 57K color temperatures are compatible with 0-10V, ELV, and Lutron Hi-lume® Power Supplies. Warm Dim (27D, 30D) color temperatures are only compatible with ELV power supplies.

2-Wire EcoSystem Wiring Diagram

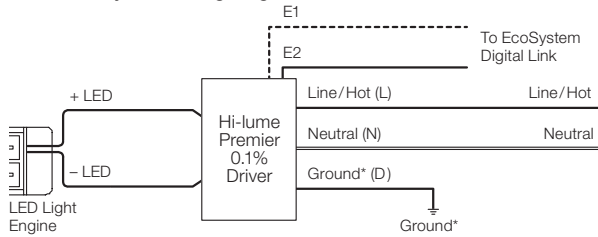

LTEA4U1UKL-CV240

3-Wire Wiring Diagram

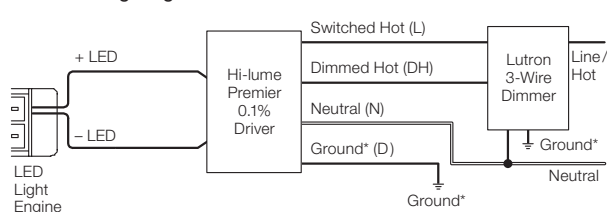

L3DA4U1UKL-CV240

PROJECT	FIXTURE TYPE	DATE
---------	--------------	------

TM30 DATA

24VDC LED MAKE-IT-YOUR-OWN SUSPENSION, STATIC WHITE & WARM DIM

TM-30-15 DATA: The data below is for SS5C and SS7C bare LED Soft Strips. Consistent color temperatures throughout a single strip and among multiple strips is possible through a 3 phase binning process in which each order is inspected with a color meter to ensure uniformity.

2200K | Rf: 83.9 | Rg: 94.9

Color Vector Graphic

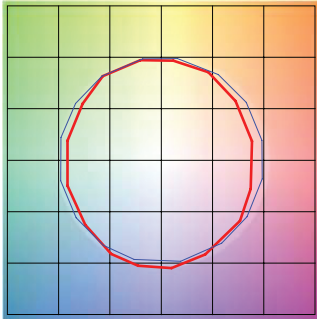

■ Test ■ Reference

HUE BIN	Rf	GRAPHIC SHIFTS %	
		CHROMA	HUE
1	78.8	-9.5%	1.3%
2	80.7	-7.8%	6.7%
3	78.2	-3.3%	9.4%
4	89.7	-2.8%	3.6%
5	93.2	-0.8%	2.6%
6	93.0	-0.6%	-0.7%
7	87.7	-5.9%	-3.5%
8	89.2	-6.8%	1.9%
9	83.4	-5.6%	6.0%
10	79.3	-3.7%	10.8%
11	81.4	2.9%	11.1%
12	84.9	5.3%	4.9%
13	88.1	4.9%	-10.1%
14	68.1	0.1%	-19.5%
15	86.0	-3.3%	-7.3%
16	76.4	-8.9%	-11.7%

2400K | Rf: 91.2 | Rg: 96.8

Color Vector Graphic

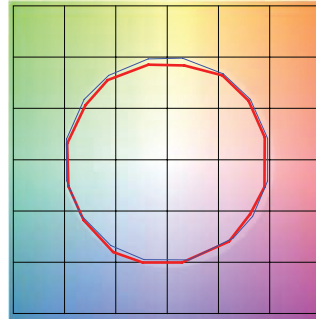

■ Test ■ Reference

HUE BIN	Rf	GRAPHIC SHIFTS %	
		CHROMA	HUE
1	92.0	-2.4%	1.5%
2	94.7	-2.1%	0.0%
3	95.4	-1.9%	-0.1%
4	88.7	-6.7%	-3.1%
5	92.8	-5.6%	1.0%
6	92.7	-3.4%	3.4%
7	89.9	-4.3%	4.1%
8	92.4	-1.4%	4.4%
9	89.0	-0.6%	5.8%
10	88.9	0.4%	6.2%
11	89.7	4.0%	5.4%
12	92.6	3.0%	-0.7%
13	90.9	1.1%	-7.0%
14	89.9	0.5%	-5.8%
15	92.1	-3.2%	0.1%
16	88.9	-1.7%	-6.3%

2700K | Rf: 87.7 | Rg: 96.1

Color Vector Graphic

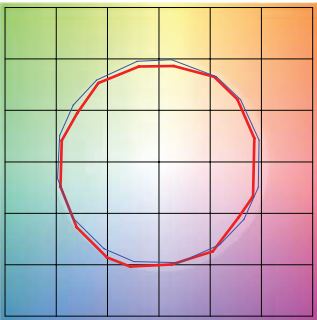

■ Test ■ Reference

HUE BIN	Rf	GRAPHIC SHIFTS %	
		CHROMA	HUE
1	88.0	-4.3%	2.6%
2	91.6	-2.4%	2.0%
3	93.7	-1.4%	1.9%
4	88.9	-5.6%	-3.1%
5	92.3	-5.5%	-0.5%
6	92.9	-3.5%	0.1%
7	84.5	-7.5%	4.6%
8	90.8	-3.0%	4.4%
9	84.5	-1.3%	8.3%
10	83.9	2.0%	9.8%
11	87.2	5.3%	7.1%
12	89.2	5.4%	-2.6%
13	88.7	0.3%	-7.8%
14	86.8	1.7%	-9.3%
15	87.6	-5.4%	-1.3%
16	83.6	-3.3%	-9.5%

3000K | Rf: 88.1 | Rg: 99.7

Color Vector Graphic

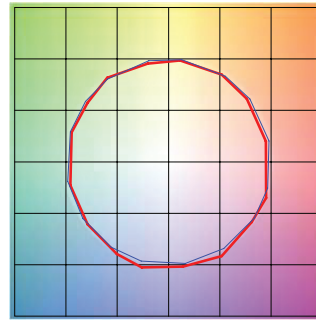

■ Test ■ Reference

HUE BIN	Rf	GRAPHIC SHIFTS %	
		CHROMA	HUE
1	92.5	-3.1%	0.3%
2	93.3	-2.3%	1.9%
3	90.9	-0.8%	3.9%
4	94.3	-1.1%	1.4%
5	92.5	-2.6%	1.5%
6	96.4	1.2%	-0.3%
7	92.6	-2.5%	-0.0%
8	96.9	-1.4%	0.2%
9	92.3	-1.8%	4.3%
10	86.6	-0.7%	7.0%
11	86.5	2.4%	8.2%
12	89.8	5.9%	1.7%
13	93.9	2.6%	-2.7%
14	89.4	5.1%	-5.8%
15	90.1	-0.1%	-4.7%
16	86.5	0.3%	-9.7%

3500K | Rf: 86.1 | Rg: 95.5

Color Vector Graphic

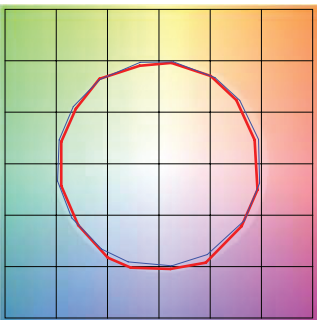

■ Test ■ Reference

HUE BIN	Rf	GRAPHIC SHIFTS %	
		CHROMA	HUE
1	90.8	-3.8%	0.3%
2	92.3	-2.8%	2.1%
3	89.7	-1.0%	4.3%
4	92.6	-1.4%	1.7%
5	91.8	-3.1%	1.3%
6	96.2	0.8%	-0.4%
7	92.9	-3.2%	0.2%
8	94.3	-2.5%	1.5%
9	90.4	-2.5%	5.2%
10	84.3	-1.4%	9.5%
11	83.1	3.5%	9.8%
12	88.2	4.8%	3.4%
13	94.0	2.7%	-2.0%
14	88.7	5.9%	-5.8%
15	88.7	0.7%	-5.9%
16	86.8	-0.7%	-6.7%

4000K | Rf: 87.6 | Rg: 96.8

Color Vector Graphic

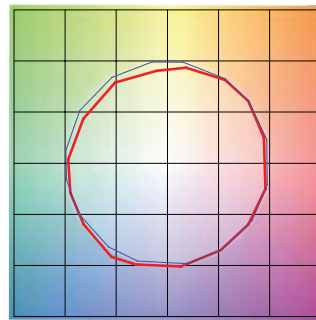

■ Test ■ Reference

HUE BIN	Rf	GRAPHIC SHIFTS %	
		CHROMA	HUE
1	88.9	-2.4%	2.5%
2	93.3	-0.4%	0.8%
3	94.8	-1.0%	-0.6%
4	87.9	-4.9%	-3.6%
5	85.3	-9.4%	-2.6%
6	90.2	-6.0%	0.2%
7	85.3	-7.6%	4.6%
8	83.7	-4.1%	8.2%
9	79.5	-1.1%	13.8%
10	78.6	1.5%	12.1%
11	83.5	6.4%	7.8%
12	90.9	3.6%	-1.1%
13	88.3	1.7%	-6.3%
14	91.9	-0.4%	-2.2%
15	84.5	-0.9%	-5.5%
16	84.7	-1.1%	-4.4%

PROJECT	FIXTURE TYPE	DATE
---------	--------------	------

TM30 DATA

24VDC LED MAKE-IT-YOUR-OWN SUSPENSION, STATIC WHITE & WARM DIM

TM-30-15 DATA: The data below is for SS5C and SS7C bare LED Soft Strips. Consistent color temperatures throughout a single strip and among multiple strips is possible through a 3 phase binning process in which each order is inspected with a color meter to ensure uniformity.

5700K | Rf: 80.3 | Rg: 91.5

Color Vector Graphic

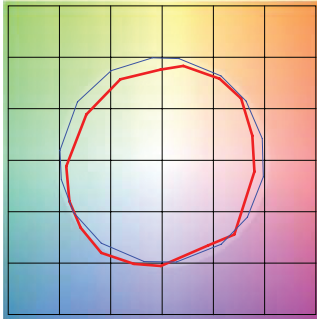

■ Test ■ Reference

HUE BIN	Rf	GRAPHIC SHIFTS %	
		CHROMA	HUE
1	75.4	-8.9%	4.7%
2	87.5	-2.6%	4.6%
3	90.7	-3.0%	-0.5%
4	83.2	-6.0%	-5.7%
5	76.2	-12.9%	-5.3%
6	81.4	-11.9%	-2.6%
7	74.8	-14.0%	5.1%
8	69.0	-9.0%	14.1%
9	72.6	-3.6%	22.2%
10	71.4	2.7%	16.1%
11	81.3	7.9%	5.3%
12	83.6	4.1%	-9.4%
13	78.4	0.7%	-15.3%
14	77.7	-6.2%	-11.0%
15	68.8	-1.3%	-21.2%
16	80.8	-9.6%	3.3%

2700D | Rf: 89.5 | Rg: 100.8

Color Vector Graphic

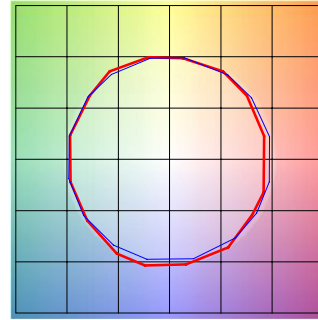

■ Test ■ Reference

HUE BIN	Rf	GRAPHIC SHIFTS %	
		CHROMA	HUE
1	88.8	-5.1%	1.4%
2	89.8	-2.7%	4.1%
3	87.2	0.3%	5.9%
4	92.3	-0.9%	1.0%
5	93.3	1.5%	1.7%
6	92.4	3.6%	-0.2%
7	92.2	-0.9%	-2.4%
8	96.7	-0.4%	-1.1%
9	92.3	-1.2%	3.7%
10	88.9	-0.0%	6.1%
11	86.4	5.1%	7.4%
12	88.2	6.3%	-0.9%
13	87.2	3.8%	-8.1%
14	84.2	3.8%	-11.0%
15	89.8	-2.6%	-4.3%
16	82.7	-3.4%	-11.1%

3000D | Rf: 89.8 | Rg: 101.4

Color Vector Graphic

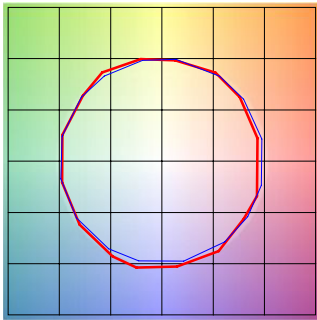

■ Test ■ Reference

HUE BIN	Rf	GRAPHIC SHIFTS %	
		CHROMA	HUE
1	90.2	-4.2%	1.5%
2	90.9	-2.0%	3.7%
3	87.9	0.8%	5.5%
4	92.1	-0.9%	0.6%
5	93.0	1.5%	1.6%
6	92.2	3.9%	-0.2%
7	92.1	-0.3%	-2.0%
8	96.7	0.0%	-1.2%
9	92.5	-0.6%	3.7%
10	88.3	1.1%	7.0%
11	87.2	4.1%	7.4%
12	87.2	6.7%	-1.0%
13	88.2	3.8%	-7.2%
14	85.3	4.3%	-9.9%
15	90.9	-2.2%	-3.6%
16	83.4	-2.2%	-11.2%

PROJECT	FIXTURE TYPE	DATE
---------	--------------	------