

# INDOOR DMX RGB/RGBW 24VDC CONSTANT VOLTAGE

24VDC WITH DMX DRIVER, RGB & RGB+W

## COLOR CHANGING (DMX) POWER SUPPLIES & RECOMMENDED CONTROLLERS

ORDERING CODE	PSB-100W-24VDC-RGB	PSB-2X100W-24VDC-RGB	PSB-3X100W-24VDC-RGB	PSB-4X100W-24VDC-RGB
<b>SPECIFICATIONS</b>				
<b>MAXIMUM LOAD</b>	100W	2X100W	3X100W	4X100W
<b>INPUT VOLTAGE</b>	120-277VAC	120-277VAC	120-277VAC	120-277VAC
<b>OUTPUT VOLTAGE</b>	24VDC	24VDC	24VDC	24VDC
<b>DIMENSIONS</b>	12.14" X 6.48" X 2.18"	14" X 10" X 3"	17" X 13" X 3"	17" X 13" X 3"
<b>CLASSIFICATION</b>	CLASS 2	CLASS 2	CLASS 2	CLASS 2
<b>T-BAR MOUNTING</b>	PSB-100W-24VDC-RGB-TB	PSB-2X100W-24VDC-RGB-TB	PSB-3X100W-24VDC-RGB-TB	PSB-4X100W-24VDC-RGB-TB
<b>IN-WALL MOUNTING</b>	PSB-100W-24VDC-RGB-IW	N/A	N/A	N/A
<b>T-BAR MOUNTING (T-BAR CHICAGO PLENUM)</b>	PSB-100W-24VDC-RGB-TBCP	PSB-2X100W-24VDC-RGB-TBCP	PSB-3X100W-24VDC-RGB-TBCP	PSB-4X100W-24VDC-RGB-TB
<b>DIMMING &amp; CONTROLS</b>				
<b>TOUCH SCREEN CONTROLLER (CTP)</b>	•	•	•	•
<b>COLOR DIAL CONTROLLER (CDP)</b>	•	•	•	•
<b>DMX 1 ZONE RGBW TOUCH CONTROLLER (CDMX1-RGBW)</b>	•	•	•	•

## RECOMMENDED CONTROLLERS

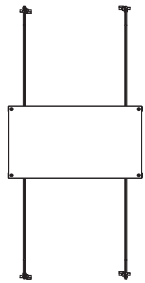

### T-BAR MOUNTING KIT

Includes power supply, box cover, and T-bar hangers for installing Junction Box above ceiling with in easy reach. Comes with 4' of 14 gauge pair Teflon cables with quick secure connectors.

**ORDERING CODES:** PSB-100W-24VDC-RGB-TB  
 PSB-2X100W-24VDC-RGB-TB  
 PSB-3X100W-24VDC-RGB-TB  
 PSB-4X100W-24VDC-RGB-TB  
 PSB-100W-24VDC-RGB-TBCP  
 PSB-2X100W-24VDC-RGB-TBCP  
 PSB-3X100W-24VDC-RGB-TBCP  
 PSB-4X100W-24VDC-RGB-TBCP

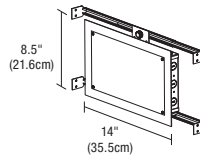

### 8.5" X 14" IN-WALL MOUNTING KIT

Includes Power Supply, Box Cover, and Stud Hangers for installing Junction Box in wall. Use ordering code in the In-Wall Mounting row of the specification table if an In-Wall Mounting Kit is needed.

**ORDERING CODES:** PSB-100W-24VDC-RGB-IW

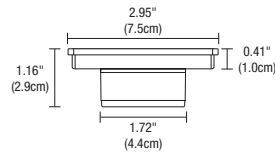
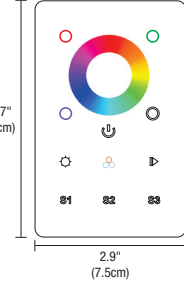
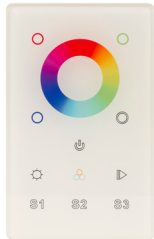

### DESCRIPTION

Full touch controller offers fast and accurate color tone adjustment and independent brightness control. The 1 zone controller can adjust RGB & RGBW LEDs smoothly and accurately. Independent smooth dimming of each channel enables the controller to achieve millions of colors. For indoor applications only, and includes a Power Adapter to operate the controller.

### APPLICATIONS

Indoor

### POWER INPUT

120-277VAC

### INSTALLATION

Fits in a single gang 2.5" deep junction box, not to be used with a multi gang box

### OUTPUT SIGNAL

USITT DMX 512 (1990)

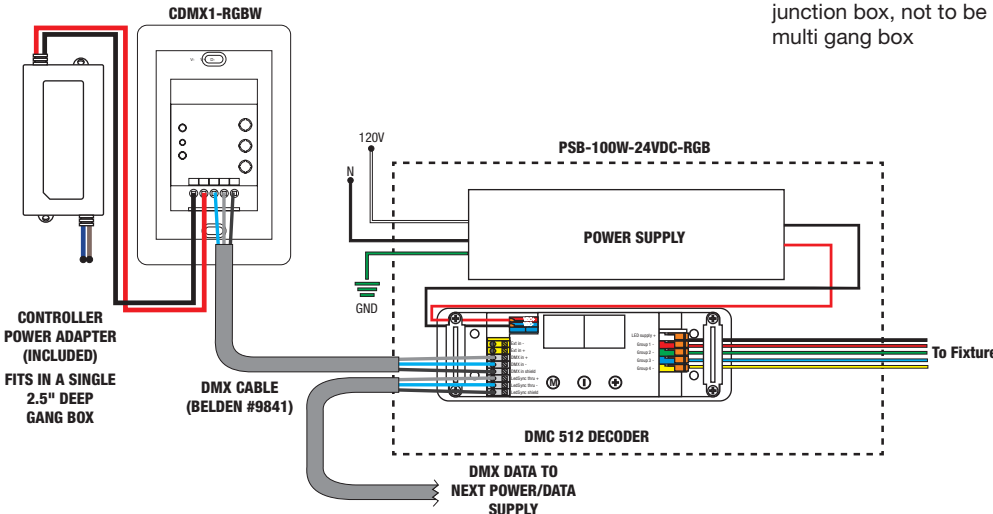

Product	Type	Finish
<b>CDMX1</b>	<b>RGBW</b>	<b>WH</b>
CDMX1 DMX 1 Zone Touch Controller	RGBW RGB & RGBW	WH White

PROJECT	FIXTURE TYPE	DATE
---------	--------------	------

**DESCRIPTION**

Full touch controller offers fast and accurate color tone adjustment and independent brightness control. The 10 zone controller can adjust Tunable White, RGB and RGBW LEDs smoothly and accurately. Independent smooth dimming of each channel enables the controller to achieve millions of colors. For indoor applications only, and includes a Power Adapter to operate the controller.

**FEATURES AND BENEFITS**
**KEY FEATURES:**

- Sleek glass design which sits 11mm from the wall
- Graphical color display to show selected environment
- Color/dimmer/speed palette
- Color temperature mixing
- Touch sensitive buttons. No mechanical parts
- Touch sensitive wheel allows for accurate color selection
- Multi-zone microSD memory
- Multi-room control with 500 scenes, 10 zones
- 1024 DMX channels. Control 340 RGB fixtures
- USB & Ethernet connectivity for programming and control
- RS232, Dry Contact Ports and an Infra Red input port
- Clock and calendar with Sunrise/Sunset triggering
- Network communication. Control lighting remotely
- Catalog of designs including black and white glass
- OEM customization of the color palette and logo
- Windows/Mac software to set dynamic colors/effects
- iPhone/iPad/Android remote and programming apps

**APPLICATIONS**

Indoor

**POWER ADAPTER**

9VDC 0.65A (included)

**POWER INPUT**

7VDC 0.6A

**OUTPUT SIGNAL**

DMX512 1,024 channels total

**INPUT SIGNAL**

Universal IR receiver (Sold Separately), RS232, Contact Closure, Live Computer Link, DMX512, WiFi

**CONNECTIONS**

USB, Ethernet, RS232, Clock, 8 dry contact ports, open drain output

**MEMORY**

microSD (32GB Max)

**COMPUTER AND MOBILE DEVICE REQUIREMENTS**
**IPHONE/IPAD/ANDROID:**

The controller may be used with any of the following apps: DMX Lightpad 3, Easy Remote and Arcolis may be downloaded from App Store or Google Play.

**ESA PRO SOFTWARE (WINDOWS ONLY, TIMELINE AND MULTI-ZONE):**

Windows ME, XP, Vista, 7 or 8 (32 bits and US 2.0, computer connection required for initial setup only.)

**ESA2 SOFTWARE (WINDOWS/MAC, SINGLE ZONE):**

Windows ME, XP, Vista, 7 or 8

Mac OS X 10.7 (Lion), 10.8 (Mountain lion), 10.9 (Mavericks), 10.10 (Yosemite)

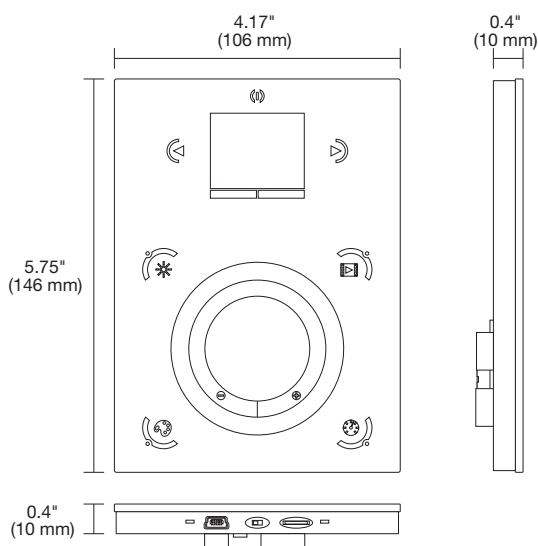

Product	Finish
<b>CTP</b>	<b>BK</b>
CTP Color Touch Screen Controller with Power Adapter	BK Black WH White

PROJECT	FIXTURE TYPE	DATE	
---------	--------------	------	--

**RGB Wiring Diagram**

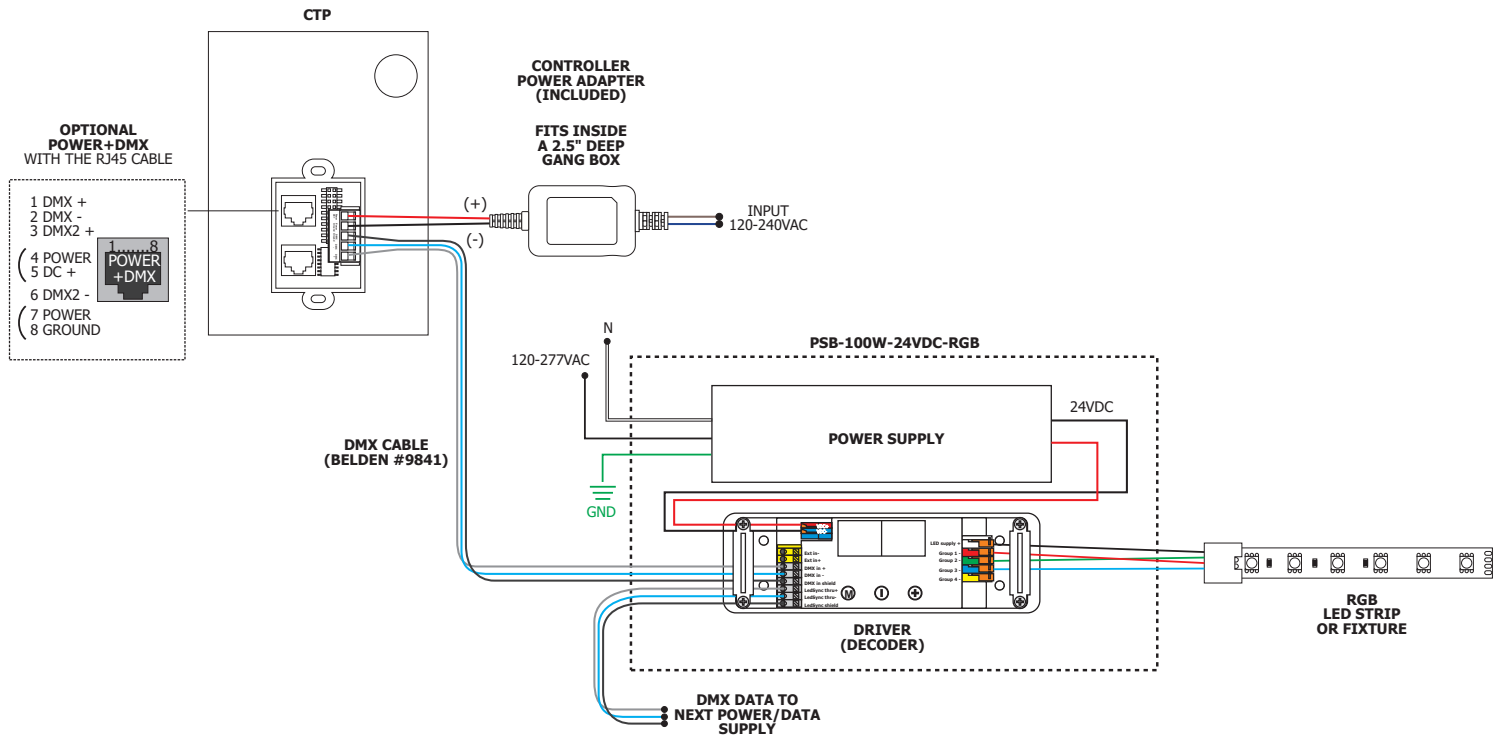

**RGBW Wiring Diagram**

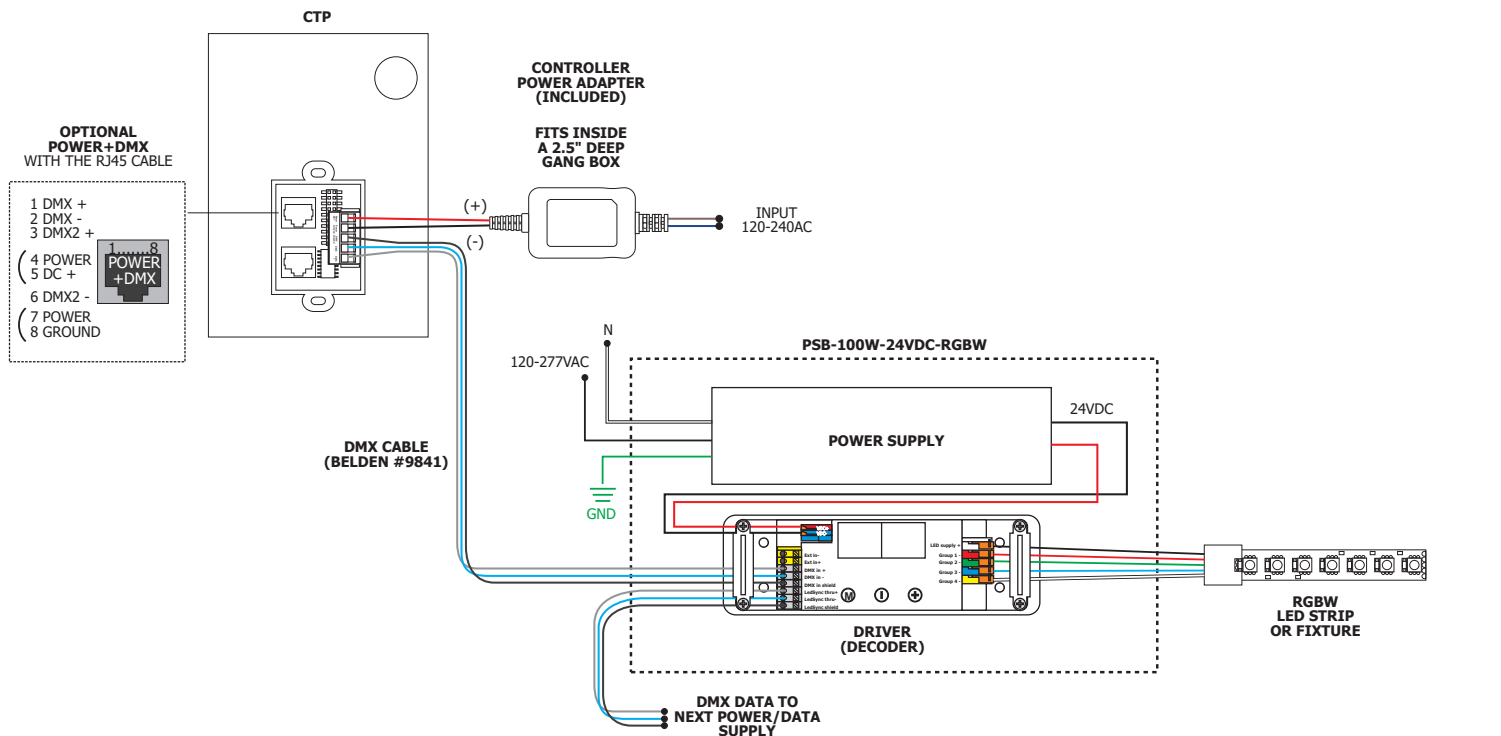

PROJECT		FIXTURE TYPE		DATE	
---------	--	--------------	--	------	--