

## Installation Instructions for Splice Box

### IMPORTANT INFORMATION

- This instruction shows a typical installation.

**SAVE THESE INSTRUCTIONS!**

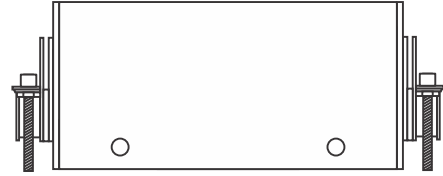

## Installing Splice Box

**A**

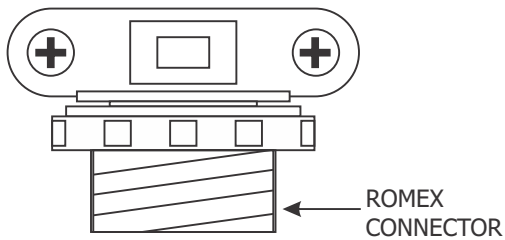

**1:** Remove the two Romex Connectors from packaging .

**B**

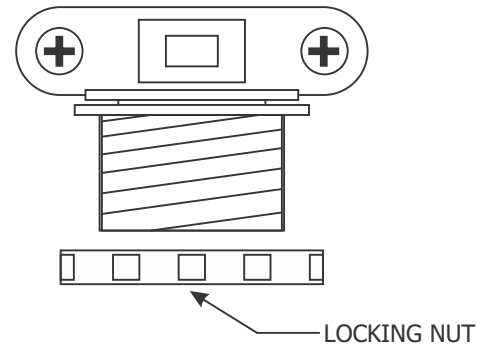

**2:** Unscrew locking nut from Romex connector.

**C**

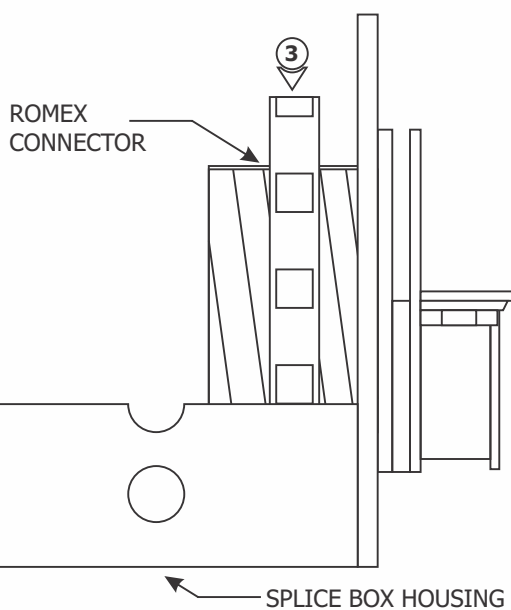

**3:** Mount Romex Connector onto splice box. Ensure threads are on the inside of splice box. Finger tighten locking nut to splice box housing.

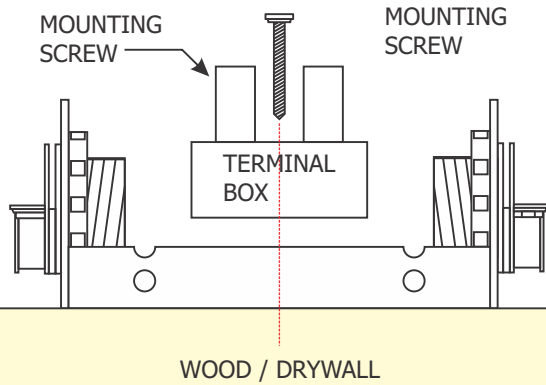
**D**

**4:** Pass mounting screw through pre-drilled center holes in terminal box and splice box housing. Use drill/screwdriver to affix the splice box to wood/drywall surface.

**5:** Run wire whips through opening in either end of the splice box..

**6:** Strip the ends of the wires and pass ends into terminal box

**7:** Use flat head screwdriver to tighten terminal box screws and secure wire whips.

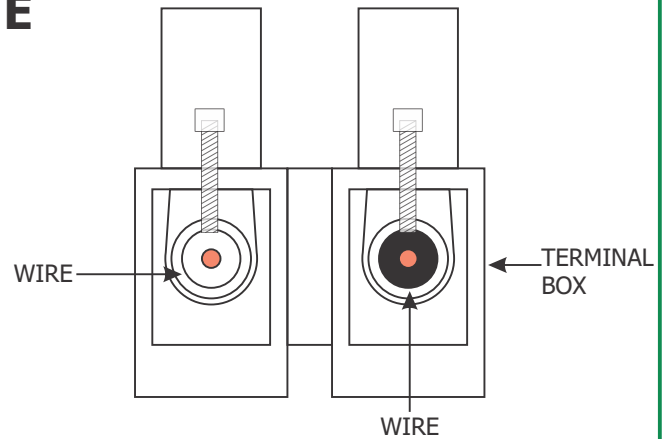
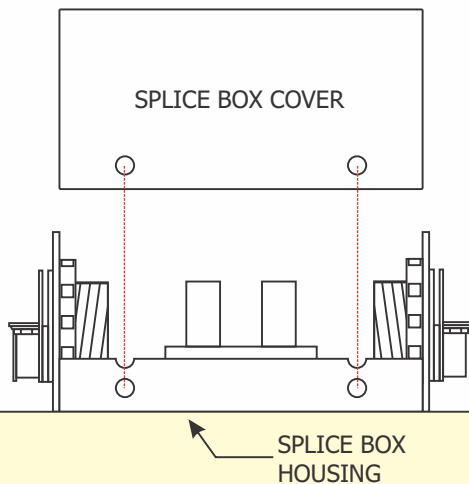
**E****F**

**8:** Place splice box cover over the assembled unit, and align with joining tabs on housing to secure splice box cover.

**9:** Use a Phillips-Head screwdriver to secure wire fastener clamps.

**G**